

See discussions, stats, and author profiles for this publication at: <https://www.researchgate.net/publication/237282216>

CIA-Initiated Remote Viewing Program at Stanford Research Institute

Article

CITATIONS
20

READS
75,070

1 author:



Harold E. Puthoff

Institute for Advanced Studies at Austin

72 PUBLICATIONS 1,734 CITATIONS

SEE PROFILE

Some of the authors of this publication are also working on these related projects:



First above yes, second no [View project](#)



General Relatively [View project](#)

CIA-Initiated Remote Viewing Program at Stanford Research Institute

H. E. PUTHOFF

Institute for Advanced Studies at Austin, 4030 Braker Lane W., Ste. 300, Austin, TX 78759

Abstract — In July 1995 the CIA declassified, and approved for release, documents revealing its sponsorship in the 1970s of a program at Stanford Research Institute in Menlo Park, CA, to determine whether such phenomena as remote viewing "might have any utility for intelligence collection".¹ Thus began disclosure to the public of a two-decade-plus involvement of the intelligence community in the investigation of so-called parapsychological or *psi* phenomena. Presented here by the program's Founder and first Director (1972-1985) is the early history of the program, including discussion of some of the first, now declassified, results that drove early interest.

Introduction

On April 17, 1995, President Clinton issued Executive Order Nr. 1995-4-17, entitled *Classified National Security Information*. Although in one sense the order simply reaffirmed much of what has been long-standing policy, in another sense there was a clear shift toward more openness. In the opening paragraph, for example, we read: "In recent years, however, dramatic changes have altered, although not eliminated, the national security threats that we confront. These changes provide a greater opportunity to emphasize our commitment to open Government." In the Classification Standards section of the Order this commitment is operationalized by phrases such as "If there is significant doubt about the need to classify information, it shall not be classified." Later in the document, in reference to information that requires continued protection, there even appears the remarkable phrase "In some exceptional cases, however, the need to protect such information may be outweighed by the public interest in disclosure of the information, and in these cases the information should be declassified."

A major fallout of this reframing of attitude toward classification is that there is enormous pressure on those charged with maintaining security to work hard at being responsive to reasonable requests for disclosure. One of the results is that FOIA (Freedom of Information Act) requests that have languished for months to years are suddenly being acted upon.²

One outcome of this change in policy is the government's recent admission

¹From "CIA Statement on 'Remote Viewing'," CIA Public Affairs Office, 6 September 1995.

²One example being the release of documents that are the subject of this report — see the memoir by Russell Targ elsewhere in this volume.

of its two-decade-plus involvement in funding highly-classified, special access programs in remote viewing (RV) and related *psi* phenomena, first at Stanford Research Institute (SRI) and then at Science Applications International Corporation (SAIC), both in Menlo Park, CA, supplemented by various in-house government programs. Although almost all of the documentation remains yet classified, in July 1995, 270 pages of SRI reports were declassified and released by the CIA, the program's first sponsor (Puthoff & Targ, 1974-5)³. Thus, although through the years columns by Jack Anderson and others had claimed leaks of "psychic spy" programs with such exotic names as Grill Flame, Center Lane, Sunstreak and Star Gate, CIA's release of the SRI reports constitutes the first documented public admission of significant intelligence community involvement in the *psi* area.

As a consequence of the above, although I had founded the program in early 1972, and had acted as its Director until I left in 1985 to head up the Institute for Advanced Studies at Austin (at which point my colleague Ed May assumed responsibility as Director), it was not until 1995 that I found myself for the first time able to utter in a single sentence the connected acronyms CIA/SRI/RV. In this report I discuss the genesis of the program, report on some of the early, now declassified, results that drove early interest, and outline the general direction the program took as it expanded into a multi-year, multi-site, multi-million-dollar effort to determine whether such phenomena as remote viewing "might have any utility for intelligence collection" (see footnote 1).

Beginnings

In early 1972 I was involved in laser research at Stanford Research Institute (now called SRI International) in Menlo Park, CA. At that time I was also circulating a proposal to obtain a small grant for some research in quantum biology. In that proposal I had raised the issue whether physical theory as we knew it was capable of describing life processes, and had suggested some measurements involving plants and lower organisms (Puthoff, 1972). This proposal was widely circulated, and a copy was sent to Cleve Backster in New York City who was involved in measuring the electrical activity of plants with standard polygraph equipment. New York artist Ingo Swann chanced to see my proposal during a visit to Backster's lab, and wrote me suggesting that if I were interested in investigating the boundary between the physics of the animate and inanimate, I should consider experiments of the parapsychological type. Swann then went on to describe some apparently successful experiments in psychokinesis in which he had participated at Prof. Gertrude Schmeidler's laboratory at the City College of New York. As a result of this correspondence

³These reports cover the period January 1974 through February 1975, the second year of the program. This effort was funded at the level of \$149,555.

I invited him to visit SRI for a week in June 1972 to demonstrate such effects, frankly, as much out of personal scientific curiosity as anything else.

Prior to Swann's visit I arranged for access to a well-shielded magnetometer used in a quark-detection experiment in the Physics Department at Stanford University. During our visit to this laboratory, sprung as a surprise to Swann, he appeared to perturb the operation of the magnetometer, located in a vault below the floor of the building and shielded by μ -metal shielding, an aluminum container, copper shielding and a superconducting shield. As if to add insult to injury, he then went on to "remote view" the interior of the apparatus, rendering by drawing a reasonable facsimile of its rather complex (and heretofore unpublished) construction. It was this latter feat that impressed me perhaps even more than the former, as it also eventually did representatives of the intelligence community. I wrote up these observations and circulated it among my scientific colleagues in draft form of what was eventually published as part of a conference proceedings (Puthoff & Targ, 1975).

In a few short weeks a pair of visitors showed up at SRI with the above report in hand. Their credentials showed them to be from the CIA. They knew of my previous background as a Naval Intelligence Officer and then civilian employee at the National Security Agency (NSA) several years earlier, and felt they could discuss their concerns with me openly. There was, they told me, increasing concern in the intelligence community about the level of effort in Soviet parapsychology being funded by the Soviet security services⁴; by Western scientific standards the field was considered nonsense by most working scientists. As a result they had been on the lookout for a research laboratory outside of academia that could handle a quiet, low-profile classified investigation, and SRI appeared to fit the bill. They asked if I could arrange an opportunity for them to carry out some simple experiments with Swann, and, if the tests proved satisfactory, would I consider a pilot program along these lines? I agreed to consider this, and arranged for the requested tests.'

The tests were simple, the visitors simply hiding objects in a box and asking Swann to attempt to describe the contents. The results generated in these experiments are perhaps captured most eloquently by the following example. In one test Swann said "I see something small, brown and irregular, sort of like a leaf or something that resembles it, except that it seems very much alive, like it's even moving!" The target chosen by one of the visitors turned out to be a small live moth, which indeed did look like a leaf. Although not all responses were quite so precise, nonetheless the integrated results were sufficiently im-

⁴Documented in "Paraphysics R&D - Warsaw Pact (U)," DST-1810s-202-78, Defense Intelligence Agency (30 March 1978).

⁵Since the reputation of the intelligence services is mixed among members of the general populace, I have on occasion been challenged as to why I would agree to cooperate with the CIA or other elements of the intelligence community in this work. My answer is simply that as a result of my own previous exposure to this community I became persuaded that war can almost always be traced to a failure in intelligence, and that therefore the strongest weapon for peace is good intelligence.

pressive that in short order an eight-month, \$49,909 *Biofield Measurements Program* was negotiated as a pilot study; a laser colleague, Russell Targ, who had had a long-time interest and involvement in parapsychology joined the program; and the experimental effort was begun in earnest.

Early Remote Viewing Results

During the eight-month pilot study of remote viewing the effort gradually evolved from the remote viewing of symbols and objects in envelopes and boxes, to the remote viewing of local target sites in the San Francisco Bay area, demarked by outbound experimenters sent to the site under strict protocols devised to prevent artifactual results. Later judging of the results were similarly handled by double-blind protocols designed to foil artifactual matching. Since these results have been presented in detail elsewhere, both in the scientific literature (Targ & Puthoff, 1974; Puthoff & Targ, 1976; and Puthoff *et al.*, 1981) and in popular book format (Targ & Puthoff, 1977), I direct the interested reader to these sources. To summarize, over the years the back-and-forth criticism of protocols, refinement of methods, and successful replication of this type of remote viewing in independent laboratories (Bisaha & Dunne, 1979; Dunne & Bisaha, 1979; Jahn, 1982; and Jahn & Dunne, 1986), has yielded considerable scientific evidence for the reality of the phenomenon. Adding to the strength of these results was the discovery that a growing number of individuals could be found to demonstrate high-quality remote viewing, often to their own surprise, such as the talented Hella Hammid. As a separate issue, however, most convincing to our early program monitors were the results now to be described, generated under their own control.

First, during the collection of data for a formal remote viewing series targeting indoor laboratory apparatus and outdoor locations — a series eventually published *in toto* in the Proc. IEEE (Puthoff & Targ, 1976) — the CIA contract monitors, ever watchful for possible chicanery, participated as remote viewers themselves in order to critique the protocols. In this role three separate viewers, designated visitors V1—V3 in the IEEE paper, contributed seven of the 55 viewings, several of striking quality. Reference to the IEEE paper for a comparison of descriptions/drawings to pictures of the associated targets, generated by the contract monitors in their own viewings, leaves little doubt as to why the contract monitors came to the conclusion that there was something to remote viewing (see, for example, Figure 1 herein). As summarized in the Executive Summary of the now-released Final Report (Puthoff & Targ, 1974-5) of the second year of the program, "The development of this capability at SRI has evolved to the point where visiting CIA personnel with no previous exposure to such concepts have performed well under controlled laboratory conditions (that is, generated target descriptions of sufficiently high quality to permit blind matching of descriptions to targets by independent judges)." What happened next, however, made even these results pale in comparison.

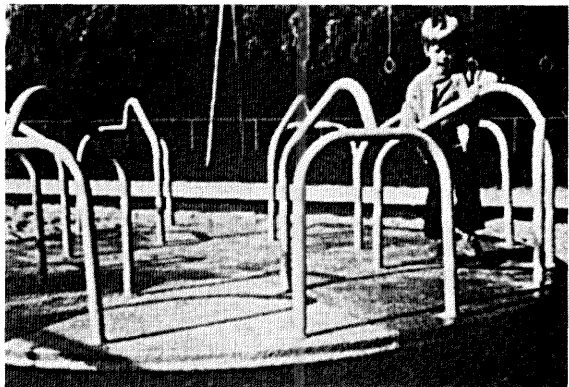
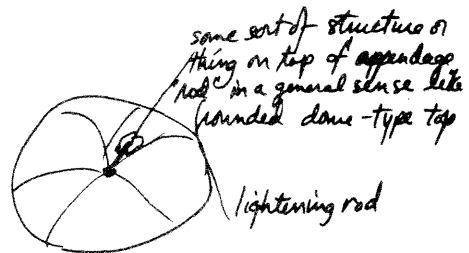
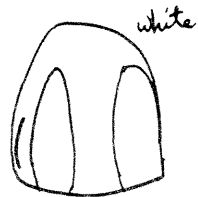
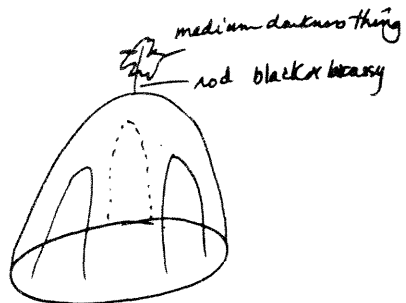

Fig. 1. Merry-go-round target and response by VI.



Top View



Coordinate Remote Viewing

To determine whether it was necessary to have a "beacon" individual at the target site, Swann suggested carrying out an experiment to remote view the planet Jupiter before the upcoming NASA Pioneer 10 flyby. In that case, much to his chagrin (and ours) he found a ring around Jupiter, and wondered if perhaps he had remote viewed Saturn by mistake. Our colleagues in astronomy were quite unimpressed as well, until the flyby revealed that an unanticipated ring did in fact exist.⁶

Expanding the protocols yet further, Swann proposed a series of experiments in which the target was designated not by sending a "beacon" person to the target site, but rather by the use of geographical coordinates, latitude and longitude in degrees, minutes and seconds. Needless to say, this proposal seemed even more outrageous than "ordinary" remote viewing. The difficulties in taking this proposal seriously, designing protocols to eliminate the possibility of a combination of globe memorization and eidetic or photographic memory, and so forth, are discussed in considerable detail elsewhere (Targ and Puthoff, 1977). Suffice it to say that investigation of this approach, which we designated *Scanate* (scanning by coordinate), eventually provided us with sufficient evidence to bring it up to the contract monitors and suggest a test under their control. A description of that test and its results, carried out in mid-1973 during the initial pilot study, are best presented by quoting directly from the Executive Summary of the Final Report of the second year's followup program. The remote viewers were Ingo Swann and Pat Price, and the entire transcripts are available in the released documents (Puthoff & Targ, 1974-5).

In order to subject the remote viewing phenomena to a rigorous long-distance test under external control, a request for geographical coordinates of a site unknown to subject and experimenters was forwarded to the OSI group responsible for threat analysis in this area. In response, SRI personnel received a set of geographical coordinates (latitude and longitude in degrees, minutes, and seconds) of a facility, hereafter referred to as the West Virginia Site. The experimenters then carried out a remote viewing experiment on a double-blind basis, that is, blind to experimenters as well as subject. The experiment had as its goal the determination of the utility of remote viewing under conditions approximating an operational scenario. Two subjects targeted on the site, a sensitive installation. One subject drew a detailed map of the building and grounds layout, the other provided information about the interior including codewords, data subsequently verified by sponsor sources (report available from COTR).⁷

Since details concerning the site's mission in general⁸, and evaluation of the remote viewing test in particular, remain highly classified to this day, all that

⁶This result was published by us in advance of the ring's discovery (Targ & Puthoff, 1977).

⁷COTR - Contracting Officer's Technical Representative.

⁸An NSA listening post at the Navy's Sugar Grove facility, according to intelligence-community chronicler Bamford (1983).

can be said is that interest in the client community was heightened considerably following this exercise.

Because Price found the above exercise so interesting, as a personal challenge he went on to scan the other side of the globe for a Communist Bloc equivalent and found one located in the Urals, the detailed description of which is also included in Puthoff & Targ (1974-5). As with the West Virginia Site, the report for the Urals Site was also verified by personnel in the sponsor organization as being substantially correct.

What makes the West Virginia/Urals Sites viewings so remarkable is that these are not best-ever examples culled out of a longer list; these are literally the first two site-viewings carried out in a simulated operational-type scenario. In fact, for Price these were the very first two remote viewings in our program altogether, and he was invited to participate in yet further experimentation.

Operational Remote Viewing (Semipalatinsk, USSR)

Midway through the second year of the program (July 1974) our CIA sponsor decided to challenge us to provide data on a Soviet site of ongoing operational significance. Pat Price was the remote viewer. A description of the remote viewing, taken from our declassified final report (Puthoff & Targ, 1974-5), reads as given below. I cite this level of detail to indicate the thought that goes into such an "experiment" to minimize cueing while at the same time being responsive to the requirements of an operational situation. Again, this is not a "best-ever" example from a series of such viewings, but rather the very first operational Soviet target concerning which we were officially tasked.

To determine the utility of remote viewing under operational conditions, a long-distance remote viewing experiment was carried out on a sponsor-designated target of current interest, an unidentified research center at Semipalatinsk, USSR.

This experiment, carried out in three phases, was under direct control of the COTR. To begin the experiment, the COTR furnished map coordinates in degrees, minutes and seconds. The only additional information provided was the designation of the target as an R&D test facility. The experimenters then closeted themselves with Subject S1, gave him the map coordinates and indicated the designation of the target as an R&D test facility. A remote-viewing experiment was then carried out. This activity constituted Phase I of the experiment.

Figure 2(a) shows the subject's graphic effort for building layout; Figure 2(b) shows the subject's particular attention to a multistory gantry crane he observed at the site. Both results were obtained by the experimenters on a double-blind basis before exposure to any additional COTR-held information, thus eliminating the possibility of cueing. These results were turned over to the client representatives for evaluation. For comparison an artist's rendering of the site as known to the COTR (but not to the experimenters until later) is shown in Figure 3.

Were the results not promising, the experiment would have stopped at this point. Description of the multistory crane, however, a relatively unusual target item, was taken as indicative of possible target acquisition. Therefore, Phase II was begun, defined by the subject being made "witting" (of the client) by client representatives who introduced themselves to the subject at that point; Phase II also included a second round of

CIA Initiated Remote Viewing

UNCLASSIFIED

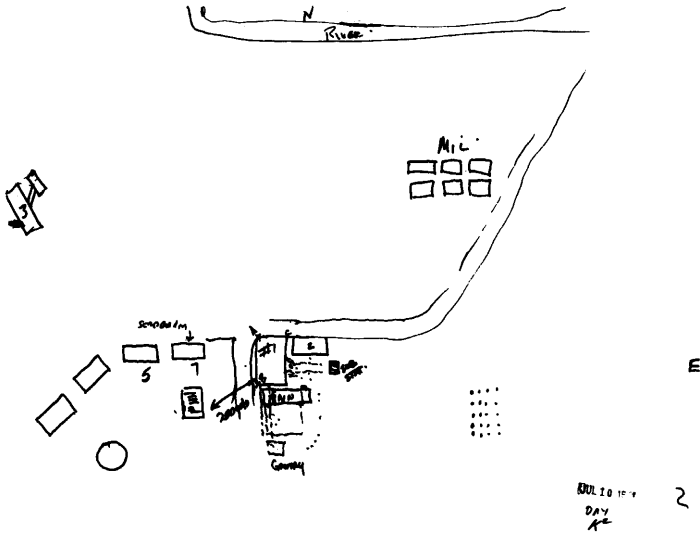

Fig. 2(a). Subject effort at building layout.

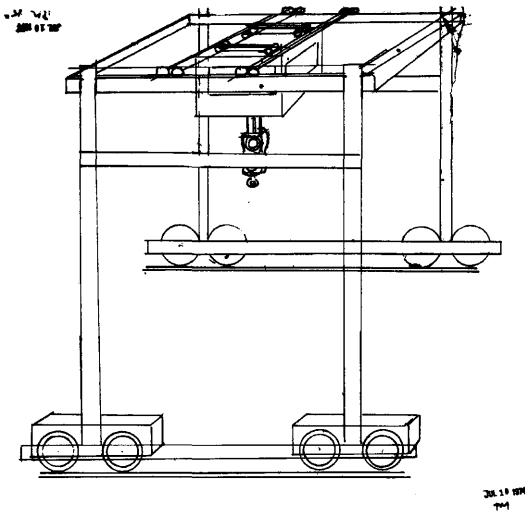

Fig. 2(b). Subject effort at crane construction.

UNCLASSIFIED

~~SECRET~~

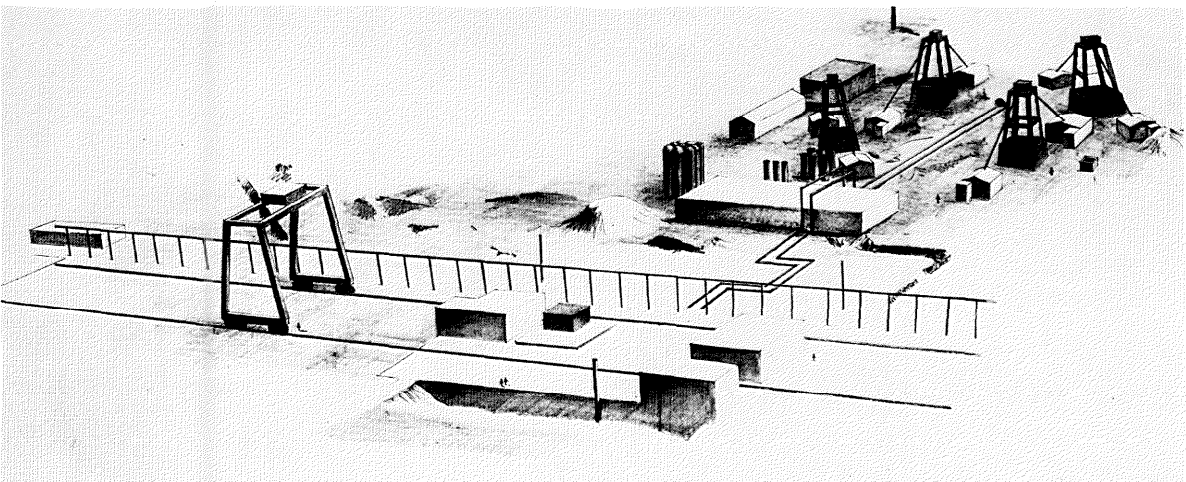

Fig. 3. Semipalatinsk, USSR target site.

~~SECRET~~



Fig. 4. Left to right: Christopher Green, Pat Price, and Hal Puthoff. Picture taken following a successful experiment involving glider-ground RV.

experimentation on the Semipalatinsk site with direct participation of client representatives in which further data were obtained and evaluated. As preparation for this phase, client representatives purposely kept themselves blind to all but general knowledge of the target site to minimize the possibility of cueing. The Phase II effort was focused on the generation of physical data that could be independently verified by other client sources, thus providing a calibration of the process.

The end of Phase II gradually evolved into the first part of Phase III, the generation of unverifiable data concerning the Semipalatinsk site not available to the client, but of operational interest nonetheless. Several hours of tape transcript and a notebook of drawings were generated over a two-week period.

The data describing the Semipalatinsk site were evaluated by the sponsor, and are contained in a separate report. In general, several details concerning the salient technology of the Semipalatinsk site appeared to dovetail with data from other sources, and a number of specific large structural elements were correctly described. The results contained noise along with the signal, but were nonetheless clearly differentiated from the chance results that were generated by control subjects in comparison experiments carried out by the COTR.

For discussion of the ambiance and personal factors involved in carrying out this experiment, along with further detail generated as Price (see Figure 4) "roamed" the facility, including detailed comparison of Price's RV-generated information with later-determined "ground-truth reality," see the accompanying article by Russell Targ in this volume.

Additional experiments having implications for intelligence concerns were

carried out, such as the remote viewing of cipher-machine type apparatus, and the RV-sorting of sealed envelopes to differentiate those that contained letters with secret writing from those that did not. To discuss these here in detail would take us too far afield, but the interested reader can follow up by referring to the now-declassified project documents (Puthoff & Targ, 1974-5).

Follow-on Programs

The above discussion brings us up to the end of 1975. As a result of the material being generated by both SRI and CIA remote viewers, interest in the program in government circles, especially within the intelligence community, intensified considerably and led to an ever-increasing briefing schedule. This in turn led to an ever-increasing number of clients, contracts and tasking, and therefore expansion of the program to a multi-client base, and eventually to an integrated joint-services program under single-agency (DIA⁹) leadership. To meet the demand for the increased level of effort we first increased our professional staff by inviting Ed May to join the program in 1976, then screened and added to the program a cadre of remote viewers as consultants, and let subcontracts to increase our scope of activity.

As the program expanded, in only a very few cases could the clients' identities and program tasking be revealed. Examples include a NASA-funded study negotiated early in the program by Russ Targ to determine whether the internal state of an electronic random-number-generator could be detected by RV processes (Targ *et al.*, 1974), and a study funded by the Naval Electronics Systems Command to determine whether attempted remote viewing of distant light flashes would induce correlated changes in the viewer's brainwave (EEG) production (Targ *et al.*, 1978). For essentially all other projects during my 14-year tenure at SRI, however, the identity of the clients and most of the tasking were classified and remain so today. (The exception was the occasional privately-funded study.) We are told, however, that further declassification and release of much of this material is almost certain to occur.

What can be said, then, about further development of the program in the two decades following 1975?¹⁰ In broad terms it can be said that much of the SRI effort was directed not so much toward developing an operational U.S. capability, but rather toward assessing the threat potential of its use against the U.S. by others. The words "threat assessment" were often used to describe the program's purpose during its development, especially during the early years. As a result much of the remote-viewing activity was carried out under conditions where ground-truth reality was a *priori* known or could be determined, such as the description of U.S. facilities and technological developments, the timing of rocket test firings and underground nuclear tests, and the location of

⁹DIA - Defense Intelligence Agency. The CIA dropped out as a major player in the mid-seventies due to pressure on the Agency (unrelated to the RV Program) from the Church-Pike Congressional Committee.

¹⁰See also the contribution of Ed May elsewhere in this volume concerning his experiences from 1985 on during his tenure as Director.

individuals and mobile units. And, of course, we were responsive to requests to provide assistance during such events as the loss of an airplane or the taking of hostages, relying on the talents of an increasing cadre of **remote-viewer/consultants**, some well-known in the field such as Keith Harary, and many who have not surfaced publicly until recently, such as Joe McMoneagle.

One might ask whether in this program RV-generated information was ever of sufficient significance as to influence decisions at a policy level. This is of course impossible to determine unless policymakers were to come forward with a statement in the affirmative. One example of a possible candidate is a study we performed at SRI during the Carter-administration debates concerning proposed deployment of the mobile MX missile system. In that scenario missiles were to be randomly shuffled from silo to silo in a silo field, in a form of high-tech shell game. In a computer simulation of a twenty-silo field with randomly-assigned (hidden) missile locations, we were able, using **RV-generated** data, to show rather forcefully that the application of a sophisticated statistical averaging technique (sequential sampling) could in principle permit an adversary to defeat the system. I briefed these results to the appropriate offices at their request, and a written report with the technical details was widely circulated among groups responsible for threat analysis (Puthoff, 1979), and with some impact. What role, if any, our small contribution played in the mix of factors behind the enormously complex decision to cancel the program will probably never be known, and must of course *a priori* be considered in all likelihood negligible. Nonetheless, this is a prototypical example of the kind of tasking that by its nature potentially had policy implications.

Even though the details of the broad range of experiments, some brilliant successes, many total failures, have not yet been released, we have nonetheless been able to publish summaries of what was learned in these studies about the overall characteristics of remote viewing, as in Table 5 of Puthoff *et al.* (1981). Furthermore, over the years we were able to address certain questions of scientific interest in a rigorous way and to publish the results in the open literature. Examples include the apparent lack of attenuation of remote viewing due to seawater shielding (submersible experiments) (Puthoff *et al.*, 1981), the amplification of RV performance by use of error-correcting coding techniques (Puthoff, 1985; Puthoff, 1986), and the utility of a technique we call *associational* remote viewing (ARV) to generate useful predictive information (Puthoff, 1984).¹¹

As a sociological aside, we note that the overall efficacy of remote viewing in a program like this was not just a scientific issue. For example, when the Semipalatinsk data described earlier was forwarded for analysis, one group declined to get involved because the whole concept was deemed unscientific nonsense, while a second group declined because, even though it might be real, it was possibly demonic; a third group had to be found. And, as in the case

¹¹For example, one application of this technique yielded not only a published, statistically significant result, but also a return of \$26,000 in 30 days in the silver futures market (Puthoff, 1984).

of public debate about such phenomena, the program's image was on occasion as likely to be damaged by an overenthusiastic supporter as by a detractor. Personalities, politics and personal biases were always factors to be dealt with.

Official Statements/Perspectives

With regard to admission by the government of its use of remote viewers under operational conditions, officials have on occasion been relatively forthcoming. President Carter, in a speech to college students in Atlanta in September 1995, is quoted by Reuters as saying that during his administration a plane went down in Zaire, and a meticulous sweep of the African terrain by American spy satellites failed to locate any sign of the wreckage. It was then "without my knowledge" that the head of the CIA (Adm. Stansfield Turner) turned to a woman reputed to have psychic powers. As told by Carter, "she gave some latitude and longitude figures. We focused our satellite cameras on that point and the plane was there." Independently, Turner himself also has admitted the Agency's use of a remote viewer (in this case, Pat Price).¹² And recently, in a segment taped for the British television series *Equinox*¹³, Maj. Gen. Ed Thompson, Assistant Chief of Staff for Intelligence, U.S. Army (1977-1981), volunteered "I had one or more briefings by SRI and was impressed.... The decision I made was to set up a small, in-house, low-cost effort in remote viewing...."

Finally, a recent unclassified report (Mumford *et al.*, 1995) prepared for the CIA by the American Institutes for Research (AIR), concerning a remote viewing effort carried out under a DIA program called Star Gate (discussed in detail elsewhere in this volume), cites the roles of the CIA and DIA in the history of the program, including acknowledgment that a cadre of full-time government employees used remote viewing techniques to respond to tasking from operational military organizations.¹⁴

As information concerning the various programs spawned by intelligence-community interest is released, and the dialog concerning their scientific and social significance is joined, the results are certain to be hotly debated. Bearing witness to this fact are the companion articles in this volume by Ed May, Director of the SRI and SAIC programs since 1985, and by Jessica Utts and Ray Hyman, consultants on the AIR evaluation cited above. These articles address in part the AIR study. That study, limited in scope to a small fragment of the overall program effort, resulted in a conclusion that although laboratory research showed statistically significant results, use of remote viewing in intelligence gathering was not warranted.

¹²The direct quote is given in Targ's contribution elsewhere in this volume.

¹³"The Real X-Files," Independent Channel 4, England (shown 27 August 1995); to be shown in the U.S. on the Discovery Channel.

¹⁴"From 1986 to the first quarter of FY 1995, the DoD paranormal psychology program received more than 200 tasks from operational military organizations requesting that the program staff apply a paranormal psychological technique know [sic] as "remote viewing" (RV) to attain information unavailable from other sources." (Mumford *et al.*, 1995).

Regardless of one's *a priori* position, however, an unimpassioned observer cannot help but attest to the following fact. Despite the ambiguities inherent in the type of exploration covered in these programs, the integrated results appear to provide unequivocal evidence of a human capacity to access events remote in space and time, however falteringly, by some cognitive process not yet understood. My years of involvement as a research manager in these programs have left me with the conviction that this fact must be taken into account in any attempt to develop an unbiased picture of the structure of reality.

References

- Bamford, J. (1983). *The puzzle palace*. New York: Penguin Books, 218.
- Bisaha, J. P. and B. J. Dunne (1979). Multiple subject and long-distance precognitive remote viewing of geographical locations. In *Mind at large*, edited by C. T. Tart, H. E. Puthoff and R. Targ. New York: Praeger, 107.
- Dunne, B. J. and J. P. Bisaha (1979). Precognitive remote viewing in the Chicago area: a replication of the Stanford experiment. *J. Parapsychology*, 43, 17.
- Jahn, R. G. (1982). The persistent paradox of psychic phenomena: an engineering perspective. *Proc. IEEE*, 70, 136.
- Jahn, R. G. and B. J. Dunne (1986). On the quantum mechanics of consciousness with application to anomalous phenomena. *Found. Phys.*, 16, 721.
- Jahn, R. G. and B. J. Dunne (1987). *Margins of reality*. New York: Harcourt, Brace and Jovanovich.
- Mumford, M. D., A. M. Rose and D. Goslin (1995). An evaluation of remote viewing: research and applications. *American Institutes for Research* (September 29).
- Puthoff, H. E. (1972). *Toward a quantum theory of life process*. unpubl. proposal, Stanford Research Institute.
- Puthoff, H. E. and R. Targ (1974-5). Perceptual augmentation techniques. *SRI Progress Report No. 3* (31 Oct. 1974) and *Final Report* (1 Dec. 1975) to the CIA.
- Puthoff, H. E. and R. Targ (1975). Physics, entropy and psychokinesis. In *Proc. Conf. Quantum Physics and Parapsychology* (Geneva, Switzerland); (New York: Parapsychology Foundation).
- Puthoff, H. E. and R. Targ (1976). A perceptual channel for information transfer over kilometer distances: Historical perspective and recent research. *Proc. IEEE*, 64, 329.
- Puthoff, H. E. (1979). Feasibility study on the vulnerability of the MPS system to RV detection techniques. *SRI Internal Report*, 15 April 1979. Revised 2 May 1979.
- Puthoff, H. E., R. Targ and E. C. May (1981). Experimental *psi* research: Implications for physics. In *The role of consciousness in the physical world*, edited by R. G. Jahn (AAAS Selected Symposium 57, Westview Press, Boulder).
- Puthoff, H. E. (1984). ARV (associational remote viewing) applications. *Research in Parapsychology 1984*, edited by Rhea White and J. Solfvin. Metuchen, NJ: Scarecrow Press, 121.
- Puthoff, H. E. (1985). Calculator-assisted *psi* amplification. *Research in Parapsychology 1984*, edited by Rhea White and J. Solfvin. Metuchen, NJ: Scarecrow Press, p. 48.
- Puthoff, H. E. (1986). Calculator-assisted *psi* amplification II: Use of the sequential-sampling technique as a variable-length majority-vote code. *Research in Parapsychology 1985*, edited by D. Weiner and D. Radin. Metuchen, NJ: Scarecrow Press, 73.
- Targ, R. and H. E. Puthoff (1974). Information transfer under conditions of sensory shielding. *Nature*, 252, 602.
- Targ, R., P. Cole and H. E. Puthoff (1974). Techniques to enhance man/machine communication. *Stanford Research Institute Final Report on NASA Project NAS7-100* (August).
- Targ, R. and H. E. Puthoff (1977). *Mind reach*. New York: Delacorte Press.
- Targ, R., E. C. May, H. E. Puthoff, D. Galin and R. Ornstein (1978). Sensing of remote EM sources (physiological correlates). *SRI Intem'l Final Report on Naval Electronics Systems Command Project N00039-76-C-0077*, covering the period November 1975 - October 1976.