

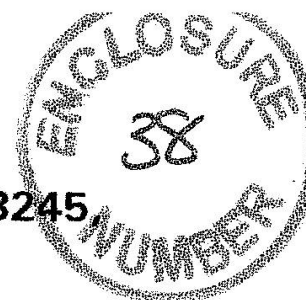

From: **Section 40** Secretariat(Air Staff)2a1a, Room 8245  
**MINISTRY OF DEFENCE**  
 Main Building, Whitehall, London SW1A 2HB



Telephone (Direct dial) 0171 218 2140  
 (Switchboard) 0171 218 9000  
 (Fax) **Section 40**

**Section 40**

Paignton,  
 Devon.

**Section 40**

Your reference

Our reference  
 D/Sec(AS)/64/3  
 Date  
 16 June 1998

**Section 40**

Thank you for your letter of 6 June in which you included a report of an unexplained aerial object seen on 11 February 1998 in the Paignton area. This office is the focal point within the Ministry of Defence for correspondence relating to "unidentified flying objects".

First I should explain that the Ministry of Defence examines any reports of "unidentified flying objects" it receives solely to establish whether what was seen might have some defence significance; namely, whether there is any evidence that the UK Air Defence Region might have been compromised by hostile or unauthorized foreign military activity.

Unless there is evidence of a potential threat to the United Kingdom from an external military source, and to date no "UFO" report has revealed such evidence, we do not attempt to identify the precise nature of each sighting reported to us. We believe that rational explanations, such as aircraft lights or natural phenomena, could be found for them if resources were diverted for this purpose, but it is not the function of the MOD to provide this kind of aerial identification service. It would be an inappropriate use of defence resources if we were to do so.

With regard to your particular observation, I have looked back through our sighting report files and can confirm that we received no other reports of "UFO" sightings for 11 February from anywhere in the UK, and we are satisfied that there is no corroborating evidence to suggest that the United Kingdom's airspace was breached by unauthorised military aircraft.

*Yours sincerely,*

**Section 40**

Section 40  
[Redacted]

PAIGNTON  
Devon Section 40

Tel: Section 40  
Ref: Section 40  
6 June, 1998

Secretariat to the Air Staff *2a*  
Ministry of Defence *Room 824S*  
Whitehall  
LONDON

Sirs,

Be pleased to draw the attention of the Air Staff to the report enclosed, forwarded for the purpose of record.

The event, lasting some twenty minutes, allowed careful study of detail, establishment of ground references etc., over terrain with which the writer is thoroughly acquainted.

The Meteorological Data needs some qualification as to value, being taken 3.75 miles distant and 250 feet lower in altitude than event site. Coastal and times of observation, differences decrease their value. They are the nearest official local obtainable.

Relevant personal C.V. details are enclosed. Should you require any further details, the writer will do his best to comply.

Yours respectfully,

Section 40  
[Redacted Signature]

Enc.

MINISTRY OF DEFENCE  
SEC (AS)1  
- 9 JUN 1998  
FILE

Relevant c.v. data

Section 40



REPORT ON EVENT AT  
BEECHDOWN PARK, NEAR PAIGNTON

On February, 11<sup>th</sup>, 1998

CONTENTS

- I. Observation
- II. Sequel to event
- III. Sketch of area
- IV. Notes relating to object
- V. Conditions appertaining
- VI. Notes

## OBSERVATION

On Wednesday, 11<sup>th</sup> February, 1998, the writer had watched a T.V. programme scheduled to finish at 8.00pm. He left his home at that time in order to exercise his dog.

Covering a short distance, 150 yards approximately, he reached a grassed area lying to the south of some letting blocks belonging to Torbay Holiday Motel. This area abuts fields in all other directions.

The nearest field, an uphill slope, is divided from said grassed area, by a 4' chain link fence, but can be accessed via a stile (Field 'A' in sketch).

Arriving at the fence, his dog behaved strangely, looking intently at an empty area about 40 feet away. Observing that place, nothing was visible until an object 'materialised' over about a 3 second period, as if brought into focus by a zoom lens. During formation it was not opaque, but became so rapidly.

The form appeared to levitate and adjust it's height to two feet (approx.) above ground level and parallel to same.

In order to check the veracity of the object, the writer tried both peripheral and averted vision. The object was real. The observer has excellent eyesight.

After deliberating whether to slip the dog and follow over the stile, it was decided to change viewpoint and continue the observation. The dog meanwhile had adopted an unusual pose, standing rigidly erect, motionless, watching the object. Difficulty was experienced in getting her to move. That accomplished, after a move along the fence, the object was still in situ and just as attractive to the dog.

Again a change of position was made and the object was observed to start to move slowly uphill. No other witnesses were about, but two cars passed on a nearby roadway.

The object continued uphill under an electrical supply cable, passing a supporting pole by some 10-15 feet, until reaching a banked hedge. This divides field 'A' from field 'B'.

Levitating, the object cleared the hedge and settled to a level commensurate with it's original height above ground. Remaining there for some time, it traversed westward along the hedge until it reached an un-gated opening between fields 'A' & 'B'. At that place it hovered in clear view for a lengthy period. The object then began to move uphill slowly alongside a north-south hedge line. Realising that from the observers' position it would be hidden from view, the observers' position was changed to one permitting maximum surveillance of the higher ground. The object continued uphill until just short of the ridge summit, and then, for want of a better word 'lit up'. Brilliance was sufficient to obscure original form.

In that condition, the object levitated and rapidly accelerated westward, clearing hedge line so disappeared at 8.30pm exactly. The dog had watched all of this intently. The event being beyond my scientific comprehension the observer returned home and made immediate notes.

### SEQUEL TO OBSERVATION

The following day, the track of the object, from appearance to disappearance, was visually searched. There were no marks of anything unusual. My dog's behaviour was as normal, apart from a great reluctance to enter the adjacent wooded area; this was most unusual.

The notes made on 11<sup>th</sup> February were loaned to a friend at Torbay Holiday Motel with a request to treat them as confidential. One person was allowed to read them, the reason being that, said person had mentioned a remarkable event at 8.30pm, February 11<sup>th</sup>, that person, a **Section 40** had been driving along the A385 towards Totnes, when a brilliant object on the southern ridge had disintegrated into several bright lights moving in agitated juxtaposition. The person had observed a similar phenomena several months before.

In an attempt to find recordings of anything similar I decided to examine some of the U.F.O. literature. Nothing resembled the object that I had seen. Interestingly, I came across a reference to a Dr. Hynek of North-West University in U.S.A., a Professor of Astronomy. Hynek was apparently the recorder of unusual sightings in the U.S.A. He had apparently advised on some U.F.O. depictions in the film 'Close Encounters of the Third Kind'. Obtaining a copy of that film, I ran it through and found two similar objects depicted. There were differences, in that the aspect ratio was much higher, and I saw only the lights on the stern face. No emission of light was detectable on the leading face.

The area of the event has been kept under intermittent observation, with nothing untoward occurring.

SKETCH OF THE AREA

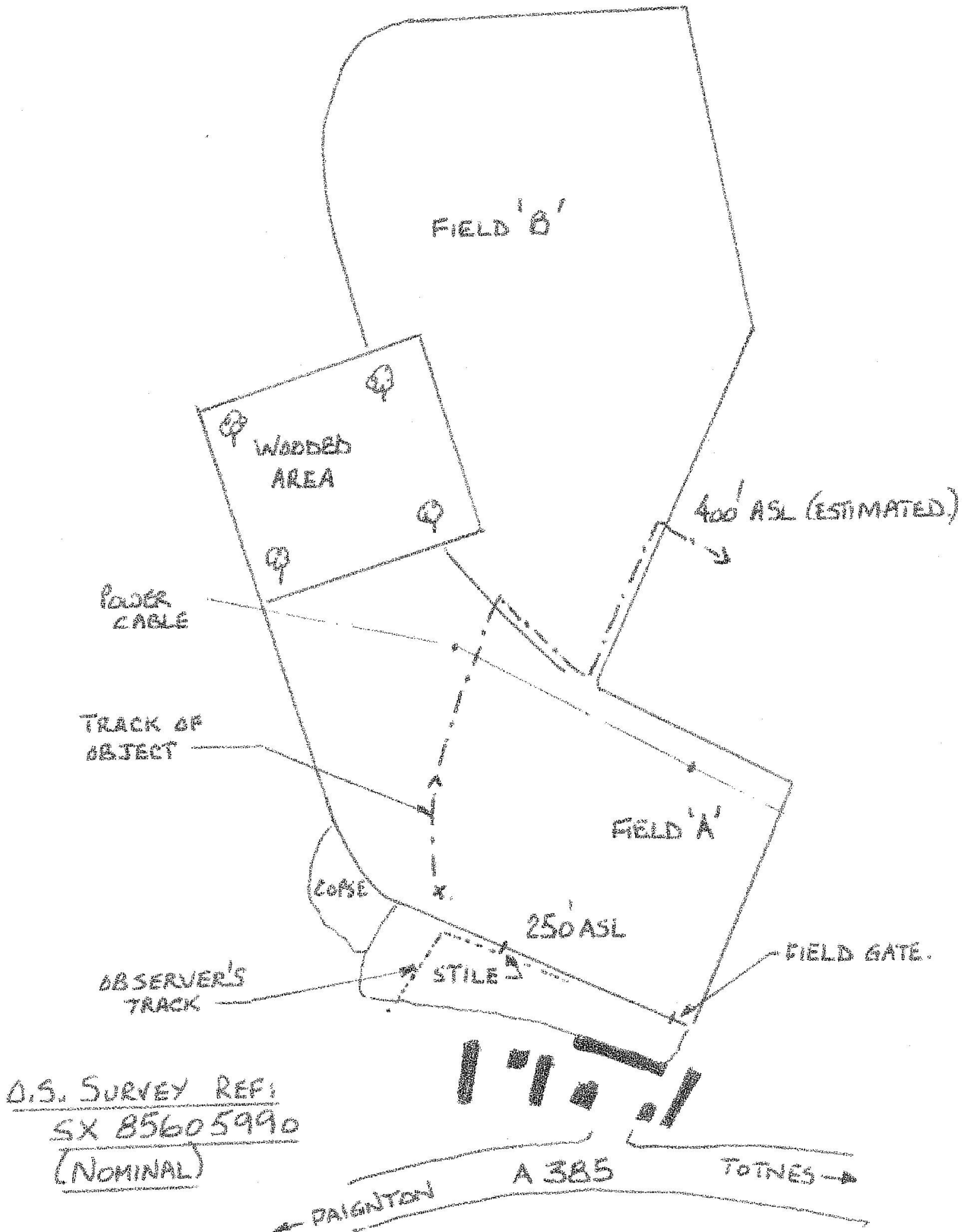

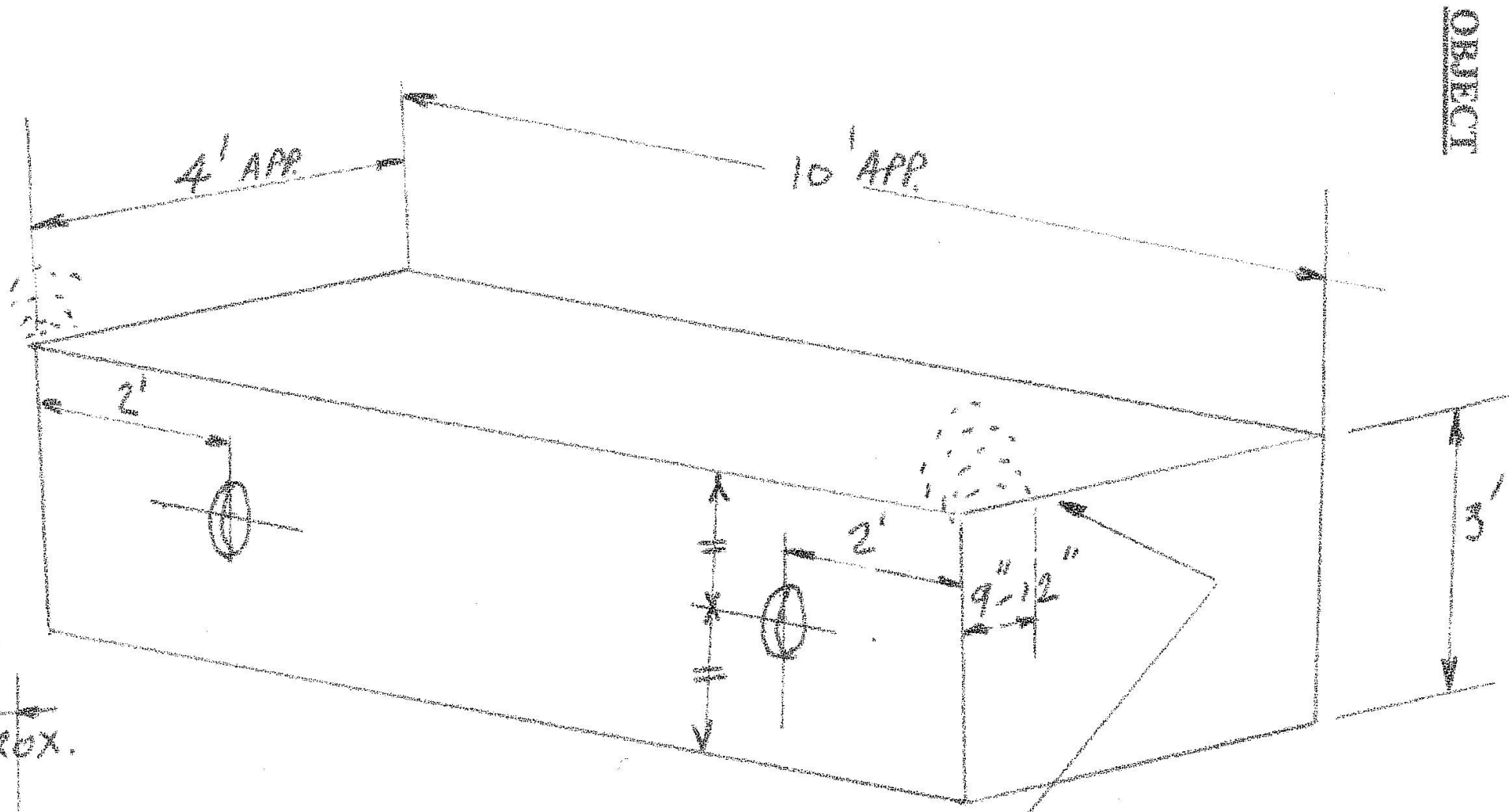

OBJECT

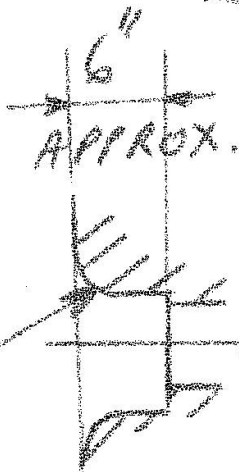

LIGHTER COLOUR THAN MAIN BODY

AXIS OF PULSE GENERATION.  
 ESTIMATED 90 C/MN AT REST.  
 ESTIMATED 300 C/MN IN MOTION.  
 THE TWO PULSED EFFECTS  
 COINCIDENTAL AT ALL TIMES.

STANDING WAVE OR FIELD EFFECT



## CONDITIONS APPERTAINING

<u>Wind</u>	South-West, approximately Beaufort 2-3 at cloud base. Less at ground level.
<u>Cloud</u>	Cumulus – stratified 8/10 broken. Estimated base 3,000 feet.
<u>Moon</u>	Near full. Elevation about 45° to my left, sometimes direct moonlight. Generally good visibility. Any freak light effect would have been down-hill. None observed.
<u>Noise</u>	None discernable.
<u>Odour</u>	Non evident
<u>Colour</u>	Charcoal until 'lit up'
<u>Trace</u>	No exhaust or trail effects
<u>Shadow</u>	None during materialisation. Afterwards normal
<u>Heat Effect</u>	None experienced or noted by observer

## NOTES

- (a) There is no doubt that the object was real, and that it was moved with intelligence and coherency.
- (b) Traverse of the banked hedge was made at the most advantageous gap, necessitating minimum levitation to clear; as was the final westerly transit.
- (c) The course entailed three changes of direction, about 90° each.

- (d) Progression uphill was with maximum frontal area in direction of travel. At no time did I see the front face of the object.
- (e) Progression along the dividing hedge line to un-gated gap was 'crab-wise' so far as orientation was concerned.
- (f) My dog's early cognisance could be connected with quicker pick-up of definition in monochrome, but I have no study on this.
- (g) The point should be made that the occurrence was immediately below the helicopter V.F.R. corridor to Plymouth and Western Units. Similarly the site is in very close proximity to the intersection of North-South and East-West air corridors, which as you will be aware, carry considerable traffic.
- (h) I cannot help but conclude that the emitted amber light was produced by some coupling with the propulsion. The cyclic rate difference between immobile and mobile were pronounced.
- (i) The 'field' effect at the stern corners is remarkable, when one considers the force intensity required to produce this effect. This without noise, smell or heat effect of 'fuel' translation. All the indications of an electro-magnetic or similar, kind of field generation.
- (j) Fields 'A' & 'B' are the property of Torbay Holiday Motel. Permanent grassland, they serve two functions. They offer leisure walking to Hotel guests and are used by a local farmer for sheep grazing. Sheep are removed in late Autumn, and not returned until after lambing, usually mid-April.

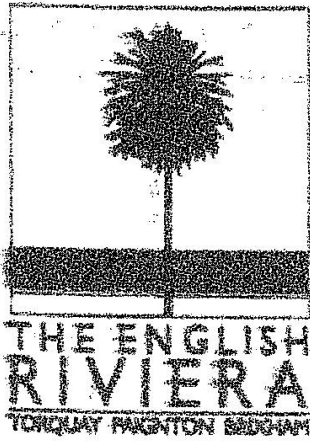

ENGLISH RIVIERA TOURIST BOARD  
WEEKLY METEOROLOGICAL REPORT  
Under the Supervision of  
The Met. Office, Bracknell, Berks.

FOR THE WEEKENDING SATURDAY 14th FEBRUARY 1998

The Thermometers, verified at Kew Observatory, are hung in a Stevenson double-louvre screen 1.22m from the ground, and placed with the 12.7mm Met. Office Rain Gauge at Abbey Park, 8m. above mean sea level. The Sunshine Recorder is a Campbell-Stokes Instrument. They are read daily at 0900 and at 1700. The observations are published by the Royal Meteorological Society and the Meteorological Office, and in provincial and daily newspapers and television.

DAILY RECORDS	Sunday 08/02	Monday 09/02	Tuesday 10/02	Wed 11/02	Thurs 12/02	Friday 13/02	Saturday 14/02
RECORDED SUNSHINE	Hr. Min 1 18	Hr. Min - -	Hr. Min - -	Hr. Min 0 6	Hr. Min 1 36	Hr. Min 6 6	Hr. Min - -
BAROMETER Corrected Mbs.	1023	1020	1023	1025	1027	1029	1031
TEMPERATURES Maximum °C	12.8 °	11.3 °	11.5 °	12.9 °	15.3 °	13.6 °	10.0 °
Minimum °C	3.2	8.3	8.6	9.1	9.3	6.9	2.0
Dry Bulb °C 9 a.m.	7.8	9.5	9.6	10.3	10.5	7.3	4.8
Minimum on Grass °C	-1.7	4.8	4.7	7.9	7.2	4.0	0.0
HUMIDITY	%	%	%	%	%	%	%
Saturation = 100 9 a.m.	91	87	88	88	96	95	97
5 p.m.	89	90	87	86	78	95	98
CLOUD 9 a.m.	6	8	7	8	8	0	8
0 = Clear Sky 8 = Entirely Overcast 5 p.m.	4	8	8	7	4	8	8
RAINFALL at Abbey Park	mm - -	mm - -	mm - -	mm Trace	mm - -	mm - -	mm Trace
SEA TEMPERATURE °C	8.4	8.6	9.0	9.2	9.6	9.5	9.5

24 November 1997  
Ref: TBMET/WKLYREP.094

Section 40  
Borough Meteorologist



From: **Section 40** Secretariat(Air Staff)2a1a, Room 8245,  
**MINISTRY OF DEFENCE**  
Main Building, Whitehall, London SW1A 2HB



Telephone (Direct dial) 0171 218 2140  
(Switchboard) 0171 218 9000  
(Fax) **Section 40**

**Section 40**

Margate,  
Kent.

**Section 40**

Your reference

Our reference  
D/Sec(AS)/64/3  
Date

16 June 1998

*DBW* **Section 40**

Your letter of 24 May addressed to **Section 40** has been passed to Sec(AS)2a which, as you know, is the focal point within the Ministry of Defence for dealing with correspondence from members of the public relating to "UFOs". You will also know the limit of the MOD's interest in this subject.

**Section 40** has already written in similar terms to your letter. In our reply to him we have explained that details of all alleged "UFO" sightings made to the Department are filed in date order on manual records and it is simply not possible to identify separate categories of data from these records without the diversion of considerable resources from elsewhere in the Department. It is our current policy that these files will be released, in accordance with the Public Record Act of 1958 and 1967, at their thirty year point.

*Yours sincerely,*

**Section 40**

UK RESTRICTED  
UNCLASSIFIED

Section 40

LOOSE MINUTE

D/DI(Sec)6/2

3 June 1998

→ Sec(AS)2a

Copy to:

DI55c

This letter implies that we're responsible for \* and that we have not accurately reflected  $\neq$  in correspondence with this public. I have prepared a draft for your consideration back to DDI Sec setting the record straight. (see attached).

Section 40 5/6

REQUEST FOR UAP SIGHTING RECORDS FROM Section 40

1. You will see from the attached that Section 40 has received correspondence direct from Section 40 and one of his associates. We are uncertain as to how Section 40 address was revealed since his move to Section 40 only happened at the end of last year. There appears to have been a breach of classified information. \*

2. Section 40 and his colleague are obviously under the misapprehension that we keep comprehensive records of all sightings of unidentified aerial phenomena(UAP). They are also overlooking the fact that reports passed to the MOD are on a confidential basis.

3. It would be unhelpful if we replied directly and developed a second line of correspondence from the MOD. Moreover although the DIS is an avowed organisation, individual appointments and detailed organisational responsibilities remain classified. Therefore there is little scope for entering into direct correspondence with the public. I would be grateful if you could respond on behalf of Section 40 pointing out that the reports MOD receives are official and in confidence. It would assist us if you could also inform them that DI55 is concerned with scientific and technical intelligence in matters of air defence and does not undertake any wider responsibilities in relation to UAP; as such DI55 does not receive all UAP reports.  $\neq$

Section 40



DDI SEC

Section 40

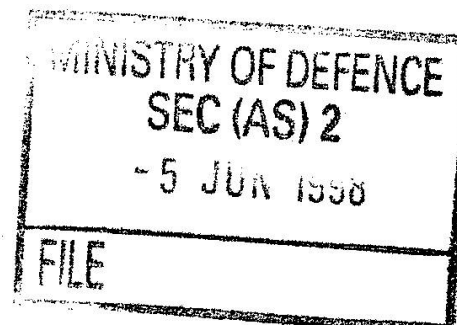

UNCLASSIFIED  
UK RESTRICTED

# WALES FEDERATION OF INDEPENDENT UFOLOGISTS



*Everyday people searching for answers*

Anglesey Branch Co-ordinator: **Section 40**  
Correspondence Address: **Section 40**

**Section 40**  
Old War Office Building  
Whitehall  
London

21/5/98

Dear Sir,

I am an industrial chemist and a member of the Royal Society of Chemistry (RSC). My main interest lies in the field of unidentified aerial phenomena. I have learned of your Department's extensive role in this field through **Section 40** of Secretariat (Air Staff) 2a and also through data currently available in the Public Record Office.

I am currently in the process of collating as much data as possible on aerial phenomena. This information will be archived either in the Royal Astronomical Society or RSC sections at Burlington House. In particular, I need details on close-up visual sightings by aircrew, details on radar sightings, details on soil/vegetation analysis and also, most importantly, classification charts on craft types.

I appreciate that you are a busy Department; however, this is precisely why we need the information so urgently. I think it's time you lads had a little help from industry and academia-if we work together, I think we can achieve this.

yours sincerely

**Section 40**

Section 40

Margate  
Kent

Section 40

24 May 1998

Section 40

Old War Office Building  
Whitehall  
London

Re: Unidentified Aerial Phenomena

Dear Sir,

I am assisting a member of the Royal Society of Chemistry (RSC) in archiving data on unidentified aerial phenomena. Through the Parliamentary Office of the RSC, Section 40 has presented a report to the Select Committee on Science and Technology outlining data currently available in the Public Record Office.

It is clear from Section 40 research that a large body of information is still unaccounted for since there are no classification charts to categorise the unidentified objects and numerous incidents alluded to in Intelligence reports are simply not available.

My understanding is that all information obtained will be archived in the library at Burlington House, the HQ of the RSC. The aim here is to provide sufficient evidence to promote the formation of a SETI sectoral panel for the next round of the DTI Foresight Programme.

I trust that you will co-operate with me on what is clearly a tremendous opportunity for DI55 to publicise some of the work that has been carried out into investigating unidentified aerial phenomena.

Kind Regards,

Section 40

MINISTRY OF DEFENCE  
OLD WAR OFFICE BUILDING  
1 JUN 1998

This enclosure has been taken off and placed on File 64/3/1 Part A *Enclosure 34*

(34)





From: **Section 40** Secretariat(Air Staff)2a1a, Room 8245,  
**MINISTRY OF DEFENCE,**  
 Main Building, Whitehall, London. SW1A 2HB



Telephone (Direct dial) **Section 40**  
 (Switchboard) 0171 218 9000  
 (Fax) **Section 40**

**Section 40**

Sheffield.

**Section 40**

Your reference

Our reference  
 D/Sec(AS)/64/3

Date  
 16 June 1998

*DAW* **Section 40**

I am writing with reference to your recent report of an unexplained aerial sighting which you observed on 6 June. The details of your report have been passed from RAF Waddington to this office as we are the focal point within the Ministry of Defence for correspondence relating to "unidentified flying objects."

First I should explain that the Ministry of Defence examines any reports of "unidentified flying objects" it receives solely to establish whether what was seen might have some defence significance; namely, whether there is any evidence that the UK Air Defence Region might have been compromised by hostile or unauthorized foreign military activity.

Unless there is evidence of a potential military threat, and to date no "UFO" report has revealed such evidence, we do not attempt to identify the precise nature of each sighting reported to us. We believe that rational explanations, such as aircraft lights or natural phenomena, could be found for them if resources were diverted for this purpose, but it is not the function of the MOD to provide this kind of aerial identification service. It would be an inappropriate use of defence resources if we were to do so.

With regard to your particular observation, I have looked back through our sighting report files and can confirm that we received no other reports of "UFO" sightings for 6 June from anywhere in the UK, and we are satisfied that there is no corroborating evidence to suggest that the United Kingdom's airspace was breached by unauthorised military aircraft.

*Yours sincerely,*

**Section 40**

*Report held on*

*64/2 pt G*

*enc. 115*



From: **Section 40** Secretariat(Air Staff)2a1a, Room 8245,  
**MINISTRY OF DEFENCE,**  
 Main Building, Whitehall, London. SW1A 2HB

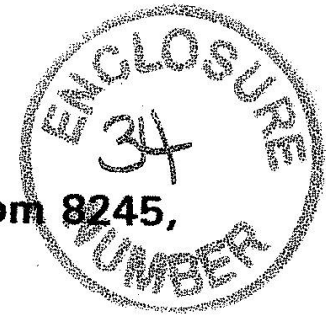

Telephone (Direct dial) 0171 218 2140  
 (Switchboard) 0171 218 9000  
 (Fax) **Section 40**

**Section 40**

South Glamorgan.

**Section 40**

Your reference

Our reference  
 D/Sec(AS)/64/3

Date  
 10 June 1998

Dear **Section 40**

1. I am writing with reference to your recent report of an unexplained aerial sighting which you observed on 29 May. The details of your report have been passed from RAF St Athan to this office as we are the focal point within the Ministry of Defence for correspondence relating to "unidentified flying objects."
2. First I should explain that the Ministry of Defence examines any reports of "unidentified flying objects" it receives solely to establish whether what was seen might have some defence significance; namely, whether there is any evidence that the UK Air Defence Region might have been compromised by hostile or unauthorized foreign military activity.
3. Unless there is evidence of a potential military threat, and to date no "UFO" report has revealed such evidence, we do not attempt to identify the precise nature of each sighting reported to us. We believe that rational explanations, such as aircraft lights or natural phenomena, could be found for them if resources were diverted for this purpose, but it is not the function of the MOD to provide this kind of aerial identification service. It would be an inappropriate use of defence resources if we were to do so.
4. With regard to your particular observation, I have looked back through our sighting report files and can confirm that we received no other reports of "UFO" sightings for 29 May from anywhere in the UK, and we are satisfied that there is no corroborating evidence to suggest that the United Kingdom's airspace was breached by unauthorised military aircraft.

Yours sincerely,

**Section 40**

Report held on  
 64/2 pt G enc. 112/1

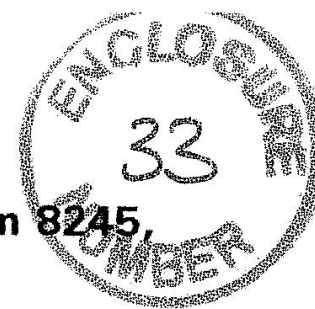

From: **Section 40** Secretariat(Air Staff)2a1a, Room 8245,  
**MINISTRY OF DEFENCE,**  
Main Building, Whitehall, London. SW1A 2HB

Telephone (Direct dial) 0171 218 2140  
(Switchboard) 0171 218 9000  
(Fax) **Section 40**

**Section 40**

Erdington,  
Birmingham.

**Section 40**

Your reference

Our reference  
D/Sec(AS)/64/3

Date  
15 June 1998

*DDAY* **Section 40**

Thank you for your letter of 3 June in which you have asked why a military jet was seen over the Harborne area of Birmingham when, in previous correspondence relating to "unidentified flying objects", I stated that military aircraft would not usually be seen over large cities.

In my last letter of 8 April, I stated that Birmingham is a low flying military aircraft avoidance area. I have made enquiries and no military jets were booked into the low flying system (ie below 2000 feet) for 30 May. Perhaps the aircraft you saw was flying above the 2000 feet limit? Whether civilian or military, any aircraft operating in the Birmingham area would be under the control of Birmingham Air Traffic Control (ATC) and operating in radio contact.

I hope this explains the position.

*Yours sincerely,*

**Section 40**

Section 40

Birmingham

Section 40

3rd June 1998

Dear Section 40

I have written to you a number of times to which you have always given me a satisfactory reply .

But could you please explain why a military jet fighter was reported over the Harborne area of Birmingham at speed on the 30th May at 3.30pm.

You once stated to me that military craft do not fly over city areas - also other strange objects were reported in the area at this time .

I look forward to your reply on the above .

Kind Regards

Section 40

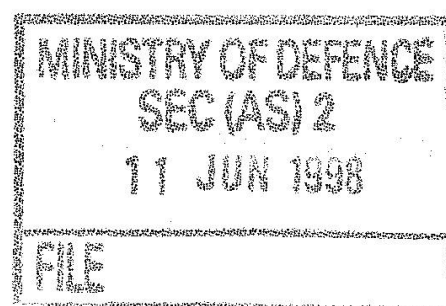



From: **Section 40** Secretariat(Air Staff)2a1a, Room 8245, 32  
**MINISTRY OF DEFENCE**  
 Main Building, Whitehall, London SW1A 2HB

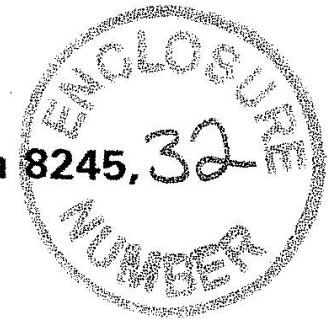

Telephone (Direct dial) 0171 218 2140  
 (Switchboard) 0171 218 9000  
 (Fax) **Section 40**

**Section 40**

Hornsea,  
 East Yorkshire.

**Section 40**

Your reference

Our reference  
 D/Sec(AS)/64/3

Date  
 15 June 1998

*DSW* **Section 40**

Thank you for your report of several "unidentified flying objects" seen in mid-December. This office is the focal point within the Ministry of Defence for correspondence of this nature and I have been asked to reply.

First I should explain that the Ministry of Defence examines any reports of "unidentified flying objects" it receives solely to establish whether what was seen might have some defence significance; namely, whether there is any evidence that the UK Air Defence Region might have been compromised by hostile or unauthorized foreign military activity.

Unless there is evidence of a potential threat to the United Kingdom from an external military source, and to date no "UFO" report has revealed such evidence, we do not attempt to identify the precise nature of each sighting reported to us. We believe that rational explanations, such as aircraft lights or natural phenomena, could be found for them if resources were diverted for this purpose, but it is not the function of the MOD to provide this kind of aerial identification service. It would be an inappropriate use of defence resources if we were to do so.

The MOD does not have any expertise or role in respect of "UFO/flying saucer" matters or to the question of the existence or otherwise of extraterrestrial lifeforms, about which it remains totally open-minded. I should add that to date the MOD knows of no evidence which substantiates the existence of these alleged phenomena.

Finally, I would like to point out that the views expressed by Mr Pope on the subject of "UFOs" are entirely his own personal opinions and do not represent nor reflect the views of the MOD.

*Yours sincerely,*

**Section 40**

REPORT 1CLOSE ENCOUNTERS OF THE 1ST ~~TOE~~ FOURTH KIND

Answer to letter.

Addressed to

Section 40

## Appendix 2

## The Form Used for Reporting UFO Sightings

## REPORT OF AN UNIDENTIFIED FLYING OBJECT

1. Date, time & duration of sighting	SIX TO EIGHT HOURS. EXACT DATE N/K, MID DEC. ON SHORT TERM RELEASE FROM HOSP.
2. Description of object (No. of objects, size, shape, colour, brightness, noise)	SEVERAL OBJECTS. RED IN COLOUR. ONE OF THEM FLAME LIKE. ALSO BECAME SURROUNDED AND NON HUMAN BEINGS. BY HUMAN
3. Exact position of observer (Indoors/outdoors, stationary/moving)	FROM BOTTOM OF A DITCH.
4. How observed (Naked eye, binoculars, other optical device, camera or camcorder)	NAKED EYE
5. Direction in which object first seen (A landmark may be more useful than a roughly estimated bearing)	<del>SEVERAL</del> ALMOST ALL DIRECTIONS.
6. Angle of sight (Estimated heights are unreliable)	VARIED
7. Distance (By reference to a known landmark)	VARIED

MINISTRY OF DEFENCE  
SEC (AS) 2  
12 JUN 1998  
FILE

OPEN SKIES. CLOSED MINDS

<p>8. Movements (Changes in 5, 6 &amp; 7 may be of more use than estimates of course and speed)</p>	
<p>9. Met: conditions during observations (Moving clouds, haze, mist etc.)</p>	<p>CLEAR SKIES FOR MOST OF THE NIGHT. FAST MOVING CLOUDS FOR REMAINING. FULL OR NEAR FULL MOON.</p>
<p>10. Nearby objects (Telephone lines, high voltage lines, reservoir, lake or dam, swamp or marsh, river, high buildings, tall chimneys, steeples, spires, TV or radio masts, airfields, generating plant, factories, pits or other sites with floodlights or night lighting)</p>	<p>I WAS SAT HIDING WERE THREE DITCHES <del>WERE</del> INTERLOCKED, IT WAS NOT VERY DEEP AND QUITE WIDE SO I HAD A VIEW OF MOST OF THE SKY</p>
<p>11. To whom reported (Police, military, press etc.)</p>	<p>NO ONE APART FROM TWO FRIENDS.</p>
<p>12. Name &amp; address of informant</p>	<p>Section 40 HORNSEA EAST YORKSHIRE Section 40</p>
<p>13. Background of informant that may be volunteered</p>	
<p>14. Other witnesses</p>	<p>N/K MUST HAVE BEEN MORE.</p>
<p>15. Date and time of receipt</p>	
<p>16. Any unusual meteorological conditions</p>	
<p>17. Remarks</p>	<p>SEE OVERLEAF.</p>

REMARKS

Here are a few.  
 For Years now I have had many strange experiences. A few years ago while I was in Sinai I was visited by someone who ask me a few questions, like a test. He then asked me for the second time if I knew who he is, then told me he is god and that I am his son. Then he showed me the sign of the cross, which sent me into a trance like state. Then I experience something I cannot explain on paper. He pulled and pushed my arm in a motion which you would use to sound a bell, at the same time as him doing this I heard the sounding of a large bell, ~~was~~ like it was right there with us. He then told me to go back to the camp with a woman he called <sup>over</sup>. Her name was Tania, for the next few days she kept saying, "Enter Estar", "Enter Taba", "Enter Mohamid" "Enter Alah".

I ran out of money shortly after arriving in Sinai, but the arabs there often invited me to eat and let me stay on their camp for nothing, one of them told me I was welcome to stay the rest of my life if I wanted, but Tania told me it was important I left with her. I was guided through Israel followed by butterflies, to a religious leader who just stood staring at me. I left <sup>and</sup> rang my mum to tell her what had happened. She was very worried and wanted me to come home. So I went home and saw a doctor, and a psychiatrist, who said he wanted me to come to his hospital for tests, so I volunteered to go, signing a contract of some sort. Ever since, I have been in and out of hospital, I can never remember being taken in, and can never remember why, and no one ever tells me why. Apart from the last time I went for a review when I told the doctor I was still telepathically in touch with god, for some reason he sees this as a reason I must be in Hospital. Now I am stuck here, as a housing benefit has stopped paying for my home.

God has told me of many things, like the whereabouts of our nearest fertile planet, and about the war in heaven, brion, and almaphere.





From: **Section 40** Secretariat(Air Staff)2a1a, Room 8245,  
**MINISTRY OF DEFENCE**  
Main Building, Whitehall, London SW1A 2HB

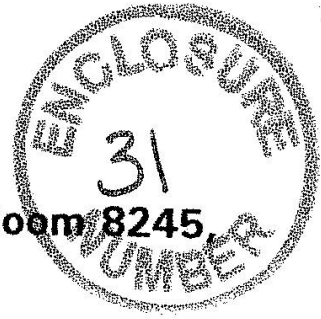

Telephone (Direct dial) 0171 218 2140  
(Switchboard) 0171 218 9000  
(Fax) **Section 40**

**Section 40**

Waltham Cross,  
Hertfordshire.

**Section 40**

Your reference

Our reference  
D/Sec(AS)/64/3

Date  
11 June 1998

*DAV*

**Section 40**

Thank you for your letter of 20 May concerning reports of 'unidentified flying objects'.

In my letter to you of 2 April I explained the MOD's limited interest in the subject of 'unidentified flying objects'. The MOD does not study or research the phenomena of 'UFO/flying saucers'; reports are looked at in the course of the Department's normal duties to establish whether there is any evidence to suggest a breach of the United Kingdom Air Defence Region by hostile or unauthorized foreign military activity.

Your letter mentions the 'alien abduction' phenomenon. As the MOD is not aware of any evidence which might substantiate the existence of extraterrestrial activity, the matter of abduction by an alien lifeform is a non-issue. Abduction/kidnap in the general sense is, of course, a criminal offence and as such would be a matter for the civil police to pursue.

Your letter mentions **Section 40** was a desk officer in the Secretariat(Air Staff)2a section from 1991-1994. However, since that time the views expressed by **Section 40** on the subject of 'UFOs' are entirely his own personal opinions and do not represent nor do they reflect the views of the MOD.

*Yours sincerely,*

**Section 40**

Section 40

Secretariat (Air Staff) 2a 1a,  
Room 8245,  
MINISTRY OF DEFENCE  
Main building, Whitehall,  
LONDON, SW1A 2HB.

Section 40

Waltham Cross,  
Hertfordshire,

Section 40

20<sup>th</sup> May 1998.

Dear,

Section 40

I am currently studying  
the UFO phenomena and I would be  
grateful for any information on UFO  
sighting reports and pictures you could send  
me.

Could you tell me your particular view on  
UFO's and whether there is a cover-up by the  
American and other governments. Also can you  
confirm that Section 40 was your predecessor?  
Have you recieved any reports of alien abduction?  
I look forward to hearing from you.

yours sincerely,

Section 40

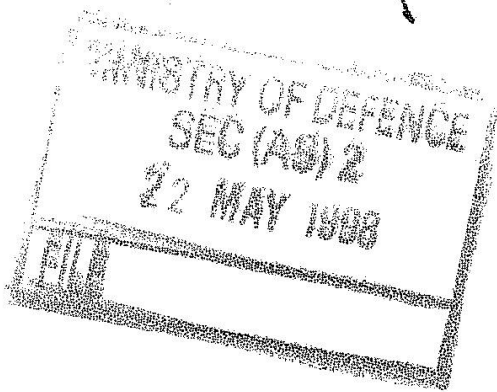



From: **Section 40** Secretariat(Air Staff)2a1a, Room 8245  
**MINISTRY OF DEFENCE**  
Main Building, Whitehall, London SW1A 2HB



Telephone (Direct dial) 0171 218 2140  
(Switchboard) 0171 218 9000  
(Fax) **Section 40**

**Section 40**

East Acton,  
London.

**Section 40**

Your reference

Our reference  
D/Sec(AS)/64/3

Date  
10 June 1998

Dear

**Section 40**

1. Thank you for your letter of 25 May.
2. You asked for background information on an incident at RAF Cosford which occurred in 1963. As previously explained in my letter of 14 April 1997, in accordance with the provisions of the Public Records Act of 1958 and 1967, all surviving contemporary paperwork relating to 'unidentified flying object' reports prior to 1967 has been transferred to the Public Records Office. It is the case that all available information prior to 1967 is a matter of Public Record and there is nothing further I can add to it.
3. Your letter also seeks information about an alleged aircraft crash at RAF Boscombe Down on 26 September 1994. On 1 December 1994 the then Minister for State for the Armed Forces, the Hon Nicholas Soames MP, answered a Parliamentary Question from the late Martin Redmond about this alleged incident. I enclose an extract from the Official report for your information.

*Yours sincerely,*

**Section 40**

HANSARD EXTRACT - 1 DECEMBER 1994

Column 907 - WRITTEN ANSWERS

**Mr. Redmond:** To ask the Secretary of State for Defence if he will make a statement on the air crash at Boscombe Down airfield on the evening of 26 September.

**Mr. Soames:** I am aware of a press report of such an incident. Staff at Boscombe Down have confirmed, however, that there was no crash at the unit on that date or, indeed, so far this year. The only flying which took place that night was the launch of two Royal Navy Sea King helicopters in support of an exercise.

Section 40

East acton Section 40

London Section 40

25-5-98

Sir, Miss, Mrs

Please can you help me with my project as i need some back ground information on a few cases i am looking into at the moment. The first one is the said incident that happen at RAF Cosford, wolverhampton, in 1963. The information i have at the moment is that a chaplain at the base, Flight-lieutenant Section 40 was talking to two RAF apprentices. He was then in the village of Albrington, advacent to RAF-cosford.

They told him that they had seen a saucer shaped object land next to a hanger. The matter was looked in to but no physical evidence was said to be found. But, and this is the main reason for me looking into the matter, on the 6 of March 1963, the Secretary of State for Air, the commander-in-chéef of the RAF, and other assorted high powered Vice marshalls, and group commanders arrived for a informal vist. It could be nothing but any little help will be greatfullý recieved.

IN the same area it is oliamed by the writer Jenny Randles, and her friend Section 40, that several other children, along with a witness saw a cigar-shaped object, which had a aura surrounding it, that made it glow. An official report was said to have been made to security police. Four hours later two Raf officers interrogated them and their parents, after which they were told that the matter was of great secrecy and made to sign a form.

The other, at RAF, Boscombe Down, in 1994. A small-twin tailed aircraft crash landed on Salisbury Plain, four miles from Stonehenge, at about 11pm, on September, 26-1994. Several enthusiasts were said to have been ushered away, away from some where the base, as they followed a disabled craft. It was at the end of the runway, covered by tarpaulins. Was this just a common plane crash?

As i say all help will be greatfullý recieved.

Yours

Section 40

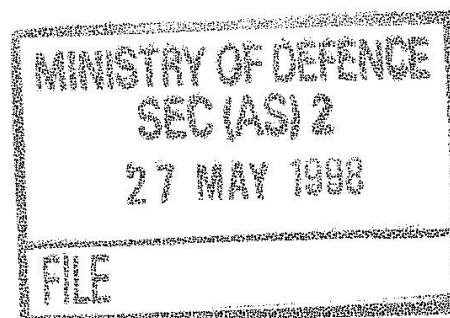

*Working  
papers***ALLEGED INCIDENT AT BOSCOMBE DOWN - 26 SEPTEMBER 1994.**

Martin Redmond MP tabled a question for reply on 29 November 1994 as a result of an item that appeared in the December 1994 issue of "Air Forces Monthly" magazine. The item alleged that an unknown USAF jet crashed onto the runway at Boscombe Down at around 2300 hrs on 26 September 1994 and that the airfield and surrounding area was sealed off. A C-5 Galaxy transport was reported to have arrived and flown the wreckage back to an Air Force Base in California two days later. The magazine believed the aircraft was a highly-classified US government black project. Subsequent press items and PQs have said that this aircraft was known as "Aurora". We have also received several enquiries from the public on this and similar subjects.

**LINES TO TAKE****Alleged crash - 26 September 1994.**

Staff at Boscombe Down have confirmed that there was no crash on that date and that the only flying that took place that night was the launch of two Royal Navy Sea King helicopters in support of an exercise. The runway was not closed and no transport aircraft other than those already based there visited Boscombe Down around the date in question.

**Existence of "Aurora".**

We are aware of press reports regarding an aircraft known as "Aurora". The Ministry of Defence has no knowledge of any US aircraft with this designation operating in UK airspace. The existence of such a programme would, in any case, be a matter for the US Government to confirm.

LOOSE MINUTE

D/Sec(AS)/64/1

10 Nov 97

APS/USofS

Section 40

**THE PEOPLE ARTICLE 5 OCTOBER 1997 - "THEY'VE BEEN HERE!"**

Reference: D/USofS/JS/28/1/0 dated 27 October 1997.

**Issue**

1. To provide advice on the Sunday People Article, "They've Been Here" of 5 October.

**Recommendation**

2. That Minister notes the following information.

**Background**

**The Author**

3. The article is clearly linked to the recent publication of "A Covert Agenda". The author of the book, Nicholas Redfern, is a full-time "UFO" researcher and is well-known to us. Since Apr 92 he has written some 25 times asking about the MOD's policy on "UFOs" and the way reports of sightings are handled by the Department, the majority of the letters being between Apr 92 and Jun 94 when Section 40 was the Sec(AS)2a desk officer.

**The Book**

4. Mr Redfern is convinced that "UFO/flying saucers" and extraterrestrial life are a matter of fact and his book is written from that perspective. He believes that the MOD and, therefore, the Government is fully aware of evidence to prove this and is withholding the information from the public. The introduction to the book is written by Section 40 who has had books about "unidentified flying objects" and the alien abduction phenomena published since leaving Sec(AS)2a and moving to another Branch.

**The Sunday People Article**

5. The alleged events in Case Histories 1-4 and number 8, and the events at RAF West Freugh all happened over 20 years ago and there is nothing in our current Branch files to substantiate any of the claims made. Any information on the 'alleged' incidents more than thirty years old (Case Histories 1, 2 and 8) will now be held in the Public Record Office and is, therefore, freely available for interpretation by 'ufologists'. To research the claims made in Case Histories 3 and 4 would require the recall of

Working  
Papers

archived files and a detailed trawl of their contents. This would be a time consuming exercise but, should Minister consider such further action necessary, we will set action in hand to recall the files. We have been able to confirm that there were no military aircraft crashes in the UK on 23 Jan 74, the date mentioned in Case History 3, which might have accounted for any unusual air activity.

6. Our 'UFO' report files reveal that on the date cited in Case History 5, 19 July 1991, three reports of 'UFOs' were received, one of which came from Kingsley, Staffordshire, very close to Ipstones. This report bore a broadly similar description but the witnesses, a **Section 40** and a **Section 40** did not see anything falling to the ground. There is nothing on the file to indicate that any further action was considered necessary to investigate what might have been seen. The other reports on that day came from Peterhead (Grampion) and Brampton (near Carlisle) and, again, no further action was taken following their receipt. As USofS will already be aware, it is not our practice to investigate reports of sightings unless there is evidence of a potential military threat.

7. The RAF Boscombe Down Case, in 1994 (No 6) was the subject of a Parliamentary Question that year (Official Report 1 Dec 94, Col 907 - copy attached). Although the Department was aware at the time of Press interest, staff at Boscombe Down confirmed that there was no aircraft crash there on 26 Sep 94, or indeed at all in 1994. The only flying out of RAF Boscombe Down which took place that night was by two Royal Navy Sea King helicopters in support of a military Exercise. Claims that members of the public were turned away by police roadblocks may have arisen from some confusion over dates. On 12 Aug 94, a Tornado participating in a trial made an emergency landing there after the decoy target under trial failed to jettison. The Tornado landed with a trailing 375 ft steel cable and, for safety reasons, roads close to Boscombe Down were closed to traffic while the aircraft passed overhead.

8. Following receipt of a letter in Jan 95 from a member of the public, an RAF Police investigation was initiated into the incident cited in Case History 7. Their enquiries revealed that a member of the public had contacted the fire services to report seeing smoke in a field, but was unable to identify the source. The local emergency services attended the scene and found a smouldering bale of hay which they extinguished. The RAF Police investigation did not reveal any evidence to suggest an item had fallen from an aircraft in the Evesham area on the day in question. There were no Royal Navy vehicles in attendance at the incident and the local police advised that nothing was removed from the scene.

#### RAF Rudloe Manor

9. The role of Rudloe Manor is constantly misrepresented and exaggerated by "UFO" enthusiasts and the media. Many "ufologists"



believe MOD "UFO" investigations have been carried out there in the past and that this continues today. Until 1992 the Flying Complaints Flight, part of the HQ Provost and Security Services(UK) based at RAF Rudloe Manor, was the central collection point for any "UFO" reports made to RAF stations (from whatever source, i.e. members of the public or service personnel). Its function was simply to record receipt of the report and pass it directly to Sec(AS)2a. Sec(AS)2a, as the Departmental focal point, was tasked with taking any further action, including consulting defence experts as necessary to establish whether what had been seen had any defence implications.

10. Since 1992, reports received by air force stations and military establishments have been forwarded direct to Sec(AS)2a and the extent of Rudloe Manor's involvement in the "UFO" reporting process, in common with all other RAF stations, has been only to note the details of anything reported in their local area and forward the information to Sec(AS).

#### Conclusion

11. Nicholas Redfern's book (a copy is available if required) is simply the latest seeking to prove the existence of "UFOs" and extraterrestrial lifeforms by re-interpreting events of the last 50 years. The first generally accepted sighting of a "UFO" occurred in June 1947 in the USA. There has been a considerable amount of media coverage this year to celebrate the 50th anniversary of this event and the Sunday People is simply giving advance publicity to one of the many books on this subject.

Section 40

Sec(AS)2a1

MB8245

Section 40

CHOTS: SEC(AS)2A (2)

Enc.

1. Official Report (1 Dec 94).

This enclosure has been taken off and placed on File 64/3/2 Part A *Enclavre 2*



From: **Section 40** Secretariat (Air Staff) 2a1  
**MINISTRY OF DEFENCE**  
 Main Building, Whitehall, London SW1A 2HB



Telephone (Direct dial) 0171 218 2140  
 (Switchboard) 0171 218 9000  
 (Fax) **Section 40**

**Section 40**

Margate

**Section 40**

Your reference

Our reference  
 D/Sec(AS)/64/3

Date  
 3 June 1998

Dear **Section 40**

1. Thank you for your letter of 14 April concerning 'unidentified flying objects' which I am afraid we did not receive until 5 May. Nevertheless, I apologise for the delay in responding to you.
2. You are aware from previous correspondence with this office that the limit of the MOD's interest in reports of 'unexplained' aerial sightings is to examine any reports received solely to establish whether what was seen might have some defence significance; namely, whether there is any evidence that the UK Air Defence Region might have been compromised by hostile or unauthorized foreign military activity. Unless there is any evidence to suggest that this may be the case no further action is taken to identify what might have been seen.
3. You comment on and ask questions about various documents held in the Public Record Office at Kew. In accordance with the provisions of the Public Records Act of 1958 and 1967, all surviving contemporary paperwork relating to 'unidentified flying object' reports prior to 1967 has been transferred to the Public Records Office. It is the case that all available information prior to 1967 is a matter of Public Record and there is nothing further I can add to it.
4. Turning now to more contemporary matters:
  - a. The alleged 'UFO' sightings in Belgium of 30/31 March 1990 (para III of your letter) occurred in the central part of the country and the Belgian authorities have confirmed that there was no evidence of a threat associated with what was seen. No detections were made on UK air defence systems. This would have been completely understandable and acceptable since the sightings occurred outside the UK Air Defence Region. We are, therefore, entirely satisfied that, with no unauthorized incursions of the UK Air Defence Region, there

was no threat to the UK. This issue therefore remains a matter for the Belgian authorities.

b. I can confirm that the MOD does not send out investigators to interview and report on 'unexplained' aerial sightings.

c. On 24 July 1996 the then Minister of State for the Armed Forces, the Hon Nicholas Soames MP, answered a Parliamentary Question from the late Martin Redmond about the alleged incident at RAF Shawbury. I enclose an extract from the Official report for your information.

d. The facts about the alleged incident at Rendlesham Forest in December 1980 remain as explained in my letter of 23 April 1997. There have been numerous subsequent claims made about these alleged events but nothing which makes the MOD believe that the assessment made at the time was incorrect.

Yours sincerely,

Section 40



WANSARD EXTRACT

Official Report - Written Answers

- Column 424 - 24 JULY 1996

**Unidentified Craft**

**Mr. Redmond:** To ask the Secretary of State for Defence (1) what is his Department's assessment of the incident that occurred on 5 November 1990 when a patrol of RAF Tornado aircraft flying over the North sea were overtaken at high speed by an unidentified craft; and if he will make a statement; [39245]

(2) if he will make a statement on the unidentified flying object sighting reported to his Department by the meteorological officer at RAF Shawbury in the early hours of 31 March 1993. [39246]

**Mr. Soames:** Reports of sightings on these dates are recorded on file and were examined by staff responsible for air defence matters. No firm conclusions were drawn about the nature of the phenomena reported but the events were not judged to be of defence significance.

1 of 2

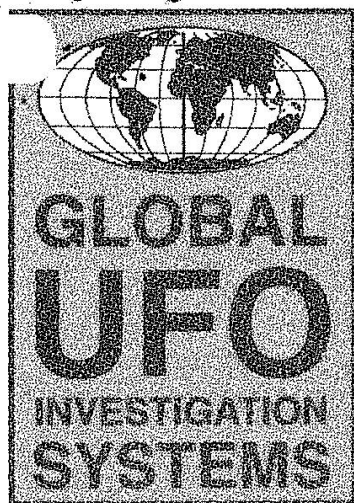

This has taken  
3 weeks to get here!  
or he stated it on 14 Apr  
and get it back week!

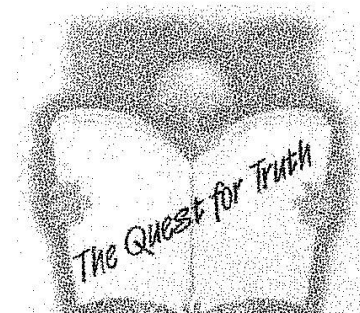

Section 40

Margate  
Kent

Section 40

Section 40

Secretariat (Air Staff) 2a1,  
MINISTRY OF DEFENCE,  
Main Building,  
Whitehall,  
London,  
SW1A 2HB.  
14th April '98.

Dear Section 40

Since your last letter of April 23rd 1997, a few things have come to my attention and i think these points need clarification, and not to mention questions answered:

I. Could you please explain why there are differences between the D.D.I.(Tech)/c.290/3/ memo, (Air 20/9321) which is dated 30th April 1957, where it stated in point 11 and i quote "It is concluded that the incident was due to the presence of five reflecting objects of Unidentified type and origin. It is considered unlikely that they were conventional aircraft, meteorological balloons or charged clouds." But yet in the Evening Standard Newspaper dated 6th April 1957 it stated that the Air ministry had said it was a weather balloon. But the detection of the UFO's was on April 4th 1957. Why was the Air Ministry saying it was a weather balloon when three weeks later, a memo from D.D.I.(Tech) which i guess was never ment to be in the public domain at the time. Ruled this out, so please could you comment.

II. In your last letter of April 23rd 1997, in point 4 you said that "I must explain that the Ministry of Defence has no interest or expertise or role with respect to "UFO/FLYING SAUCERS.". But yet in Air 20/9994 we have a memo from Headquarters No 11 Group dated 6th December 1956 - ref:11G/S.1803/7/Air Int. It says in section 2 "Sightings of aerial phenomena are to be reported in writing to the Air Ministry - D.D.I.(Tech).", (not to your office?). It also says that in section 3 "It is essential that the information could be controlled officially" my question is WHY?

III. In Air 20/9320 we have a memo from D.D.I.(Tech)/S290/ to S.6. (Mr. West) with the word secret at the top. We have a radar sighting under investigation from RAF Church Lawford on the 26th March, 1957 where a radar picked up an UNidentified object which and i quote from it "The object moved at a speed timed as exceeding 1400mph. This in itself was unusual as the object had accelerated to the speed from a stationary position.". So please comment on this? Also on this question i have a more recent event for you to comment on, given the fact that radar in 1957 picked up that object seen in the report from RAF Church Lawford, why then given all the advancements in radar technology since then, why was the Belgium Triangular UFO was allegedly not picked up on radar when it was chased by two F-16 fighters from Belgium within five miles of the Dover Coastline?

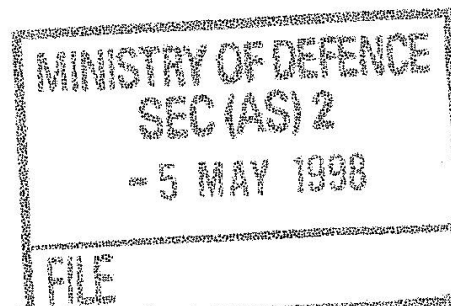

Head Office: Section 40

Littlehampton, West Sussex, United Kingdom.

Section 40

Tel: Section 40

2 of 4

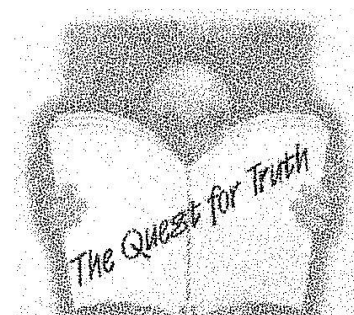
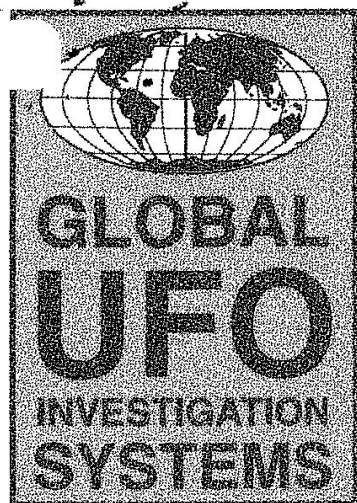

Section 40

Margate  
Kent

Section 40

IV. Does the M.O.D. send out investigators to interview and report on sightings of UFO's? Keep in mind Air Files, Air 2/16918 & Air 2/17983.

V. In Air 2/17318 we have a report of a round disc like object of silver or metallic substance over Farningham, (Kent) three questions concerning this report:

1. Why was it stamped – No unclassified reply permitted, Confidential.?
2. Why was copies going to Air Intelligence (5b)?
3. Why was it stamped D.D.I.(Tech)?

VI. Does the Ministry of Defence acknowledge that the United Kingdom Airspace has been penetrated on many occasions, and have caused Royal Air Force planes to be diverted from missions or have been scrambled to intercept "Unknown Craft"? Examples would be:

1. The 1957 interception by Two Javelin Aircraft.
2. The West Freugh incident.
3. A meteorological officer at RAF Shawbury was concerned when he witnessed a Triangular Unknown Craft on the night of March 30th 1993.
4. The case of Flt. Lt. J. Kilburn and five of his associates who reported a silver circular object (Symmetrical shape would indicate intelligent construction) that descended with a pendular motion and then accelerated away with, and i quote "incredible speed". The craft was in fact responding intelligently to an approaching Gloster Meteor. This incident occurred on 19th September 1952 at RAF Topcliffe in Yorks. (Air 16/1199). Could you comment on the above question and the four examples.

VII. In your letter to me of April 23rd 1997 in point 3 you said of the Rendlesham Forest/RAF Woodbridge incident "As there was no evidence to substantiate an event of Defence concern no further investigation into the matter was necessary.". But ten years later a team of scientists did some cursory tests on the soil in the "Alledged" landing area. Despite being a little too late, the results nevertheless make interesting reading, and i quote: "The control samples were taken at the "Alledged" landing site and at 50 and 100ft distances from the landing site; the results are summarised below;

1. The soil from the affected area had a lower field moisture content that the control samples.
2. The affected soil from the landing site was also resistant to re-hydration.
3. Under the microscope, the affected soil had higher degrees of silicate or glass globules than controls, indicating that the sand had been fused to form these tiny glass beads.
4. The landing site showed no microbial growth of any type whereas the control did. Given that the general opions by sceptics is that of American soilders running around chasing a lighthouse beam, and given that there was Nuclear Weapons on the base, do you stand by your comment?

Thank you for your continued time and patience with these questions and i hope you have had a happy easter.

Best Regards,

Section 40

Section 40

Director of Investigations, Kent Area.

Head Office: Section 40

Littlehampton, West Sussex. United Kingdom.

Section 40

Tel: Section 40



From: **Section 40** Secretariat(Air Staff)2a1a, Room 8245, 27  
**MINISTRY OF DEFENCE**  
 Main Building, Whitehall, London SW1A 2HB

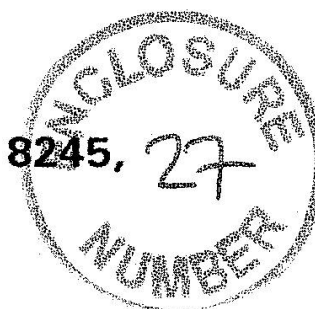

Telephone (Direct dial) 0171 218 2140  
 (Switchboard) 0171 218 9000  
 (Fax) **Section 40**

**Section 40**

Cirencester,  
 Gloucestershire.

**Section 40**

Your reference

Our reference  
 D/Sec(AS)/64/3  
 Date

2 June 1998

*DSM*

**Section 40**

1. Thank you for your letter of 19 May 1998 in which you have asked for information on the alleged incident at Rendlesham Forest in December 1980. This office is the focal point for correspondence of this nature and I have been asked to reply.
2. First I should explain that the Ministry of Defence examines any reports of "unidentified flying objects" it receives solely to establish whether what was seen might have some defence significance; namely, whether there is any evidence that the UK Air Defence Region might have been compromised by hostile or unauthorized foreign military activity.
3. Unless there is evidence of a potential threat to the United Kingdom from an external military source, and to date no "UFO" report has revealed such evidence, we do not attempt to identify the precise nature of each sighting reported to us. We believe that rational explanations, such as aircraft lights or natural phenomena, could be found for them if resources were diverted for this purpose, but it is not the function of the MOD to provide this kind of aerial identification service. It would be an inappropriate use of defence resources if we were to do so.
4. When the Ministry of Defence was informed of the events which are alleged to have occurred at Rendlesham Forest/RAF Woodbridge in December 1980, all available substantiated evidence was looked at in the usual manner by those within the MOD/RAF with responsibility for air defence matters. The judgement was that there was no indication that a breach of the United Kingdom's air defences had occurred on the nights in question. As there was no evidence to substantiate an event of defence concern no further investigation into the matter was necessary. Although a number of allegations have subsequently been made about these reported events, nothing has emerged over the last 17 years which has given us reason to believe that the original assessment made by this Department was incorrect.



5. For your information, I have enclosed a copy of the memorandum made by Lt Col Charles Halt, the then Deputy Base Commander of RAF Bentwaters, which was written some two weeks after the alleged event took place. This memorandum has been in the public domain for several years. The MOD received no other reports in connection with this alleged incident.

*Yours sincerely,*

Section 40



---

MINISTRY OF DEFENCE  
SECRETARY  
GENERAL

19/5/98

YOUR REF D/SEC(A3)/64/3

Section 40

CIRENCESTER  
GLOS

Section 40

Dear Section 40

I am writing to you requesting under the FOIA copies of the reports you have from your airmen named John Burroughs and Jim Pennington, who were involved in the Rendlesham forest incident back in 1980. I would also like to add that I understand the role that the M.D.O takes in UFO's and I know that as far as the M.D.O is concerned no breach of the UK's air defences had occurred on the

might in question, but I would like the  
chance to come to my own conclusion  
and would really appreciate it if you  
would send me these reports and any  
other reports that you may have which  
were submitted to you.

yours faithfully

Section 40

This enclosure has been taken off and placed on File 64/3/1 Part A *Enclosure 32*

*(26)*



From: **Section 40** Secretariat(Air Staff)2a1a, Room 8245,  
**MINISTRY OF DEFENCE**  
 Main Building, Whitehall, London SW1A 2HB

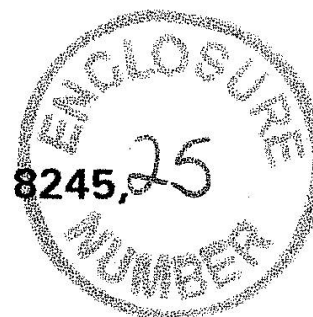

Telephone (Direct dial) 0171 218 2140  
 (Switchboard) 0171 218 9000  
 (Fax) **Section 40**

**Section 40**

Penmaenmawr,  
 Gwynedd.

**Section 40**

Your reference

Our reference  
 D/Sec(AS)/64/3  
 Date

2 June 1998

*Dear*

**Section 40**

1. Thank you for your letter of 30 April addressed to the Prime Minister. Your letter has been passed to the Ministry of Defence and this office is the focal point within the MOD for correspondence relating to "UFO/flying saucer" matters. I have been asked to reply.

2. First I should explain that the Ministry of Defence examines any reports of "unidentified flying objects" it receives solely to establish whether what was seen might have some defence significance; namely, whether there is any evidence that the UK Air Defence Region might have been compromised by hostile or unauthorized foreign military activity.

3. Unless there is evidence of a potential threat to the United Kingdom from an external military source, and to date no "UFO" report has revealed such evidence, we do not attempt to identify the precise nature of each sighting reported to us. We believe that rational explanations, such as aircraft lights or natural phenomena, could be found for them if resources were diverted for this purpose, but it is not the function of the MOD to provide this kind of aerial identification service. It would be an inappropriate use of defence resources if we were to do so.

4. The MOD does not have any expertise or role in respect of "UFO/flying saucer" matters or to the question of the existence or otherwise of extraterrestrial lifeforms, about which it remains totally open-minded. I should add that to date the MOD knows of no evidence which substantiates the existence of these alleged phenomena.

*Yours sincerely,*

**Section 40**

WFOs



## MINISTERIAL CORRESPONDENCE UNIT

To Sec (AS) 2

Ref No 3177 /1998

Date 28-5-98

The attached letter(s) which the Prime Minister has received has been forwarded to this Department for official action. No.10's letter codes are as follows:

- A - The letter has been acknowledged by No.10. Please send a full reply **within 20 working days**.
- B - The letter has been acknowledged by No.10. Please consider whether there is anything which can usefully be said to the correspondent and action accordingly.
- C** - No acknowledgement has been sent. In this case, however, it is obviously important that both an acknowledgement and a full reply are sent.

Unless specifically asked to do so, there is no need for you to copy your replies to this office.

A new Open Government Code of Practice came into force on January 1997. All replies to members of the public must be in accordance with the procedures set out in the Code. A full explanation of the Code of Practice is contained in DCI(Gen) 54/98; further information is available from DOMD on extension **Section MB**.

Under the Citizens' Charter, Departments are now required to keep record of their performance. All branches and Agencies are required to keep information on the number of requests for information which refer to the Code of Practice including details of the correspondent and the nature and date of the reply. In addition, the Department is required to provide a record of the total number of letters from members of the public and provide statistics (which may be based on a valid sample) of its performance in providing replies within their published targets.

As part of our monitoring procedure, random spot checks on the accuracy of your branch records on correspondence will be performed throughout the year.

MINISTERIAL CORRESPONDENCE UNIT  
MB 6140 EXT **Section MB**

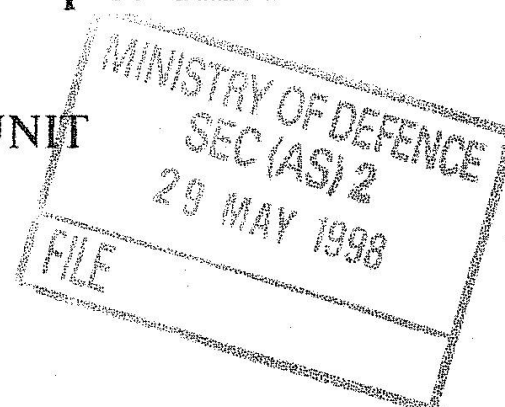

M. 0 0

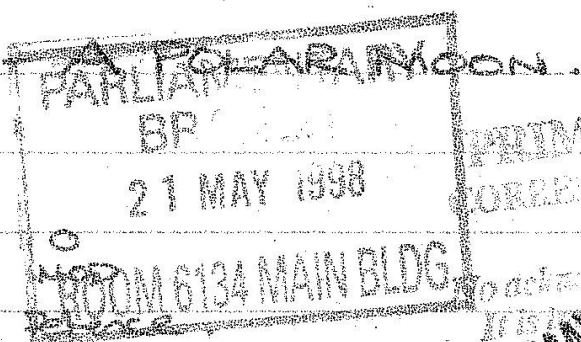

PRIME MINISTER'S  
OFFICE

09 MAY 1998  
To achieve the best possible result  
it is recommended that your  
enquiry is sent by your  
Department and a FULL REPLY  
IF NECESSARY

Section 40

PENMAENMAWR

GWYNEDD

Section 40

Mr Tony Blair, Prime Minister,

30.4.98

Sir,

3177

My letter was posted to you on the 16/4/98 which detailed an exposé made in 1992 and is titled A POLAR MOON, to which I have not received acknowledgement.

There was also a question to amuse your Cabinet, which has a serious purpose, in the same letter.

The question highlights the pre-dilection of certain elements in the world to produce horror from outer space, whilst the true horrors are bound up in NASA and its Russian Sister as the Exposé proved.

A ship from Space is nothing to fear if we bear our Bible in mind as to whom made the plane, if there is no Sanctuary for the ship, it will be difficult for all concerned and that is the required state. Sanctuary.

It is two and a half miles in diameter possesses an aerodrome, the ambition being to stem the influx of carbon monoxide from the combustion engine, which is reducing soils on a global scale, as well as entering water; and end Nuclear Powering with the same item.

There will also be help of a medical nature. Your answer is requested, and, there will be further instructions; cosmically.

Section 40



From: **Section 40** Secretariat(Air Staff)2a1a, Room 8245, 24  
**MINISTRY OF DEFENCE**  
 Main Building, Whitehall, London SW1A 2HB

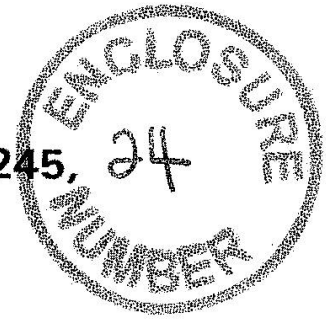

Telephone (Direct dial) 0171 218 2140  
 (Switchboard) 0171 218 9000  
 (Fax) **Section 40**

**Section 40**

Kilsyth,  
 Glasgow.

**Section 40**

Your reference

Our reference  
 D/Sec(AS)/64/3  
 Date

2 June 1998

Dear **Section 40**

1. Thank you for your recent letter regarding "UFOs" addressed to the Secretary of State for Defence. Your letter has been passed to this office as we are the focal point within the Ministry of Defence for correspondence of this nature and I have been asked to reply.
2. First I should explain that the Ministry of Defence examines any reports of "unidentified flying objects" it receives solely to establish whether what was seen might have some defence significance; namely, whether there is any evidence that the UK Air Defence Region might have been compromised by hostile or unauthorized foreign military activity.
3. Unless there is evidence of a potential threat to the United Kingdom from an external military source, and to date no "UFO" report has revealed such evidence, we do not attempt to identify the precise nature of each sighting reported to us. We believe that rational explanations, such as aircraft lights or natural phenomena, could be found for them if resources were diverted for this purpose, but it is not the function of the MOD to provide this kind of aerial identification service. It would be an inappropriate use of defence resources if we were to do so.
4. The MOD does not have any expertise or role in respect of "UFO/flying saucer" matters or to the question of the existence or otherwise of extraterrestrial lifeforms, about which it remains totally open-minded. I should add that to date the MOD knows of no evidence which substantiates the existence of these alleged phenomena.
5. I am unable to shed any light on the sighting detailed in your letter as you did not state the day on which you saw it. Therefore I cannot check whether anyone else reported anything similar or if there were any explanations which could have accounted for your sighting.

Yours sincerely,

**Section 40**



VFOs



## MINISTERIAL CORRESPONDENCE UNIT

To SEC (AS) 2

Ref No 2991 /1998

Date 20-5-98

The Secretary of State, / \_\_\_\_\_ has received the attached letter from a member of the public. It has not been acknowledged by this office.

Please send a reply on behalf of the Minister concerned. All Ministers attach importance to such letters being answered promptly, your reply should therefore be sent **within 20 working days** of the date of this minute. If, exceptionally, this should prove impossible an interim reply should be sent within the same timescale.

A new Open Government Code of Practice on Access to Government Information came into force on in January 1997. All replies to members of the public must be in accordance with the procedures set out in the Code. A full explanation of the Code of Practice is contained in DCI(Gen) 54/98; further information is available from DOMD on extension **Section MB**.

Under the Citizens' Charter, Departments are now required to keep records of their performance. All branches and Agencies are required to keep information on the number of **requests for information which refer to the Code of Practice** including details of the correspondent and the nature and date of the reply. In addition, the Department is required to provide a record of the total number of letters from members of the public and provide statistics (which may be used on a valid sample) of its performance in providing replies within their published targets.

**As part of our monitoring procedure, random spot checks on the accuracy of your branch records on correspondence will be performed throughout the year.**

MB 6140 EXT **Section MB**

MINISTRY OF DEFENCE SEC (AS) 2 21 MAY 1998 FILE
--

EXHIBITARY  
BRANCH  
20 MAY 1951  
COMMUNICATIONS

Section 40

Kilguth  
Glasgow

Section 40

2051

Dear MAD,

Could you possibly send me information about UFO's which I've read have been sighted around Britain especially around Scotland. I've read in books and maps that there have been and as far as we are lead to believe there could be at this particular moment at least of alien origin flying around Britain's air space.

PTO

I actually witnessed a flying object of unidentifiable origin but when I seen this object I had another witness a lady whose was 8 yrs older than myself, was 150 old at the time and we were watching for Halley's comet through my 50x50 refractor telescope we did see it but continued star gazing and pointed the telescope toward the sky above the town of Stepps near Glasgow when suddenly out of nowhere we seen an object hovering it did so for about 15 to 20 minutes we put the telescope a bit more stronger and could not believe it so we looked again

it was to coin a phrase out of  
this world we were actually  
observing a Flying Saucer  
we never forgotten that night  
and probably won't ever

So I'd be very grateful if  
you could send me any infor-  
mation which would be relevant  
to

Yours in anticipation

Section 40

This enclosure has been taken off and placed on File 64/3/1 Part A Enclosure 31

(23)



From: Section 40 [redacted] Secretariat(Air Staff)2a1a, Room 8245,  
**MINISTRY OF DEFENCE**  
Main Building, Whitehall, London SW1A 2HB

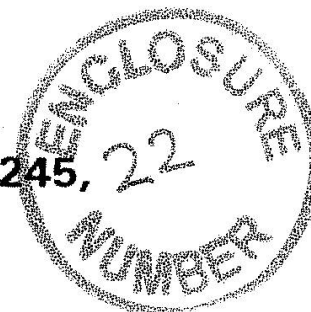

Telephone (Direct dial) 0171 218 2140  
(Switchboard) 0171 218 9000  
(Fax) Section 40 [redacted]

Section 40 [redacted]

Lancaster,  
Lancashire.

Section 40 [redacted]

Your reference

Our reference  
D/Sec(AS)/64/3  
Date

29 May 1998

*DDAV*

Section 40 [redacted]

1. Thank you for your letter of 27 May regarding a sighting over Lancaster.

2. I have looked back through our "UFO" sighting report files and can confirm that the MOD did not receive any sighting reports from anywhere in the UK for 26 May. There is no other corroborating evidence to suggest that the United Kingdom's airspace was compromised by unauthorised foreign military activity which, as explained in previous correspondence, is the MOD's only concern.

*Yours sincerely,*

Section 40 [redacted]

Section 40

Lancaster Lancs

Section 40

27th May 1998

Dear

Section 40

I am writing to find out if There's been anybody ringing in about a very bright light (ufo) over the river lane lancaster lancs.

on the 26th May 98, Time 10.05pm

me and my girlfriend was walking along the bank of the River Lane, when we saw a very, very bright round bright light moving across the clear night sky. it was not a plane. Helicopter or a Satelight, or anything else which people say they saw.

Section 40

I did have a Camera with me, but I was under a street lamp with a Orange light at the top. by the time we got over the wall the object had shot straight off to the NW over lancaster.

please could you look up your files, to see if anybody else has rung in about this sighting I would be most grateful for your answer back about this. Thankyou

Your sincerely,

MINISTRY OF DEFENCE  
SEC (AS) 2  
28 MAY 1998  
FILE

( girlfriend )

Section 40

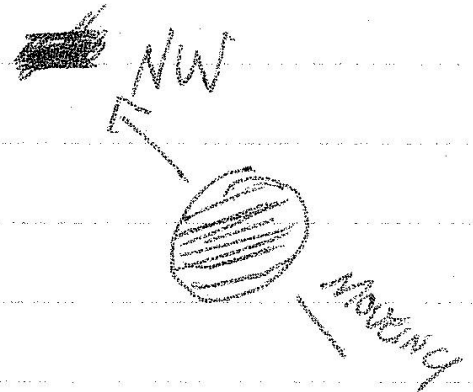



From: **Section 40**, Secretariat(Air Staff)2a1a, Room 8245,  
**MINISTRY OF DEFENCE**  
Main Building, Whitehall, London SW1A 2HB

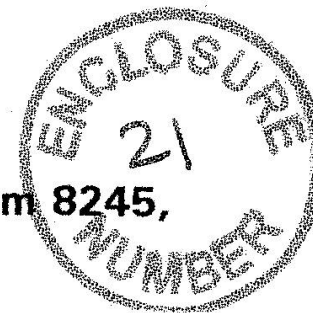

Telephone (Direct dial) 0171 218 2140  
(Switchboard) 0171 218 9000  
(Fax) **Section 40**

**Section 40**

Birmingham  
**Section 40**

Your reference

Our reference  
D/Sec(AS)/64/3  
Date

29 May 1998

*Dear* **Section 40**

1. Thank you for your letter of 19 May addressed to **Section 40**. I have been asked to reply.

2. I have looked back through our sighting report files and have found that the MOD did not receive any reports from Cornwall at any time during September 1995.

3. As requested, I have enclosed a copy of the memorandum written by Lt Col Halt on the alleged Rendlesham Forest incident which was omitted from our last letter.

*Yours sincerely,*

**Section 40**



Section 40

Ministry of Defence,  
Secretariat (Air Staff) 2a,  
Main Building,  
Whitehall,  
LONDON,  
SW1A 2HB

Section 40

BIRMINGHAM,  
Section 40

19th May, 1998

Dear Section 40

Thank you for your letter regarding the Rendlesham Forest Incident, but we did not receive a copy of Colonel Halt's report. Can you oblige, please?

Also, can you tell us whether you have any reports of UFOs seen near the Godrevy Lighthouse, Cornwall, in mid-September, 1995, when a family were on holiday at the Holiday Camp there? The reason we ask is that, according to our information, four Police Officers were involved.

Yours sincerely,

Section 40

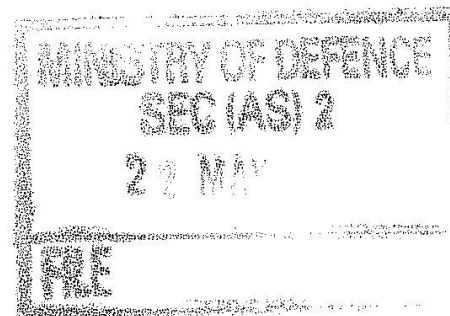

This enclosure has been taken off and placed on File 64/3/4 Part A *Enclosure 5*

*(20)*



From: **Section 40** Secretariat (Air Staff) 2a1  
**MINISTRY OF DEFENCE**  
 Main Building, Whitehall, London SW1A 2HB

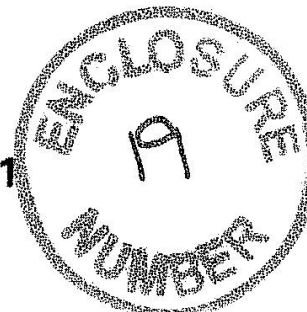

Telephone (Direct dial) 0171 218 2140  
 (Switchboard) 0171 218 9000  
 (Fax) **Section 40**

**Section 40**

Boscombe  
 Bournemouth

**Section 40**

Your reference

Our reference  
 D/Sec(AS)/64/3

Date  
 28 May 1998

Dear **Section 40**,

1. I am writing in connection with the 'unexplained' aerial sighting which you reported to the Ministry of Defence last night.
2. First you may be interested to know that the MOD examines any reports of 'unidentified flying object' it receives solely to establish whether what was seen might have some defence significance; namely, whether there is any evidence that the UK Air Defence Region might have been compromised by hostile or unauthorized foreign military activity.
3. Unless there is evidence of a potential threat to the United Kingdom from an external military source, and to date no 'unidentified flying object' sighting has revealed such evidence, we do not attempt to identify the precise nature of each reported incident. We believe that down to earth explanations could be found for these reports, such as aircraft lights or natural phenomena, if resources were diverted for this purpose but it would be an inappropriate use of defence resources to provide this kind of aerial identification service.
4. In respect of your particular sighting, I have been advised by the MOD's air defence experts that there is no evidence to suggest such a breach of the UK ADR has occurred. When you spoke to the MOD Duty Officer you said that your local paper would be visiting you on Friday 29 May and sought our approval for the visit to go-ahead. It is entirely a matter for you whether or not you talk to your local press about your sighting and you do not need MOD permission to do so. I tried to telephone you this morning to tell you this but got a BT message stating that you do not accept phonecalls where the number has been withheld. As the MOD operates on a switchboard all MOD telephone numbers are automatically withheld and I am afraid I could not get through to you.
5. I hope the above provides useful background.

Yours sincerely,

**Section 40**

*copy of report  
 held on  
 64/2 pt 6  
 enc. 105/1*