

NEXUS

NEW TIMES MAGAZINE

Volume 5, Number 1 DECEMBER 1997 - JANUARY 1998

PO Box 30, Mapleton Qld 4560, Australia

CONTENTS

LETTERS TO THE EDITOR.....	4	BRIGHT SKIES—Part 5.....	51
GLOBAL NEWS.....	6	<i>By Harry Mason. The great Kobe earthquake, the Oklahoma City bombing and the downing of TWA Flight 800 may have been caused by EM weapon strikes in a factional battle for control of our planet.</i>	
<i>A round-up of the news you probably did not see.</i>		THE TWILIGHT ZONE.....	59
FROM MAD COWS TO HUMANS.....	11	<i>Strange tales from around/within/beyond the world. This issue we focus on recent transmissions of the Mitchell-Hedges "talking" crystal skull, covering the history of the civilisation who made it, as well as prophecies about imminent Earth changes.</i>	
<i>By Lynette J. Dumble. Agricultural and health authorities did too little too late to avert a BSE species jump to humans. The emergent, fatal variant-CJD could be the next global plague.</i>		AREA 51/S-4: SECRETS BEHIND THE SCENES.....	65
DEEP BLACK: THE CIA'S SECRET DRUG WARS.....	17	<i>By Wendelle C. Stevens. This veteran UFO researcher tells the story of an ex-US Marine sentry who confirmed the presence of UFOs and aliens at Area 51/S-4 before mysteriously disappearing.</i>	
<i>By David G. Guyatt. Before they died, three former military men revealed their roles in the CIA's guns-and-drugs empire and in the surveillance of US politicians for black-budget blackmail purposes.</i>		REVIEWS—Books.....	71
POLE SHIFT 2000 CLIMATE CRISIS?—Part 2.....	23	<i>"Mind Control, Oswald, JFK: Were We Controlled?" by L. Lawrence</i>	
<i>By Richard W. Noone. If the Antarctic ice-cap continues its uneven, unstable build-up, it could soon slip, fracturing the Earth's crust and triggering a catastrophic planetary pole shift.</i>		<i>"Deadly Feasts" by Richard Rhodes</i>	
INDUCED REMISSION THERAPY—Part 1.....	29	<i>"Opening to the Infinite" by Alice Bryant and Linda Seebach</i>	
<i>By Dr Sam Chachoua. This doctor/scientist can cure cancer and AIDS with his revolutionary immunotherapy, but the medical and media mafia want to destroy him and his life-saving work.</i>		<i>"A Covert Agenda" by Nicholas Redfern</i>	
THE AMA'S CHARGE ON THE LIGHT BRIGADE.....	37	<i>"Virtual Government" by Alex Constantine</i>	
<i>By Stuart Troy. In the US in the 1920s, Dr Dinshah pioneered a preventive/curative coloured-light therapy which the AMA and FDA spent decades trying to extinguish, using ridicule and show-trials.</i>		<i>"The Feminization of Nature" by Deborah Cadbury</i>	
NEW SCIENCE NEWS.....	45	<i>"Life Extension...Protocols 1997" by William Faloon</i>	
<i>A selection of interesting news and views from the underground science network. First, we run Jerry Decker's story on the 1972 Richard Clem Over-Unity Engine; then Andrei Samokhin's write-up of a Russian breakthrough in vacuum-energy research.</i>		<i>"Where Science Went Wrong" by Peter Bros</i>	
		<i>"The Mystery of the Crystal Skulls" by C. Morton & C. L. Thomas</i>	
		<i>"The Supergods" by Maurice Cotterell</i>	
		<i>"Journey into the New Millennium" by Wendy Munro</i>	
		<i>"Vaccination: A Parent's Dilemma" by Greg Beattie</i>	
		<i>"Toxic Deception" by Dan Fagin and Marianne Lavelle</i>	
		<i>"The Estrogen Alternative" by Raquel Martin with Judy Gerstung</i>	
		REVIEWS—Videos.....	78
		<i>1997 Australian International UFO Symposium Videos</i>	
		REVIEWS—Audio.....	79
		<i>"Kilim" by Nikola Parov</i>	
		<i>"Deep in Didge" by Tribal Trance</i>	
		<i>"Halim" by Natacha Atlas</i>	
		<i>"Music of Olympic National Park" by Mars Lasar</i>	
		<i>"Travel the World with Putumayo" (compilation)</i>	
		NEXUS BOOKS, SUBS, ADS & VIDEOS.....	89

NEXUS MAGAZINE

Volume 5, Number 1

DECEMBER 1997 - JANUARY 1998

PUBLISHED BY

NEXUS Magazine Pty Ltd, ACN #003 611 434

EDITOR

Duncan M. Roads

CO-EDITOR

Catherine Simons

ASSISTANT EDITOR/SUB-EDITOR

Ruth Parnell

EDITORS' ASSISTANT

Richard Giles

OFFICE ADMINISTRATOR

Julie Lehmann

CONTRIBUTORS THIS ISSUE

George Monbiot, Lynette J. Dumble, PhD, MSc,
David G. Guyatt, Richard W. Noone, Sam
Chachoua, MB, BS, Stuart Troy, Jerry W. Decker,
Andrei Samokhin, Harry Mason, BSc, MSc, Chris
Morton, Ceri Louise Thomas, Wendelle C. Stevens

LAYOUT & DESIGN

Duncan M. Roads

CARTOONS

Phil Somerville

COVER GRAPHIC

John Cook, jscook@ozemail.com.au

PRINTING

Warwick Daily News, Queensland, Australia

AUSTRALIAN DISTRIBUTION

Newsagents Direct Distribution

HEAD OFFICE - All Correspondence

PO Box 30, Mapleton, Qld 4560, Australia.

Ph: +61 (0)7 5442 9280; Fax: +61 (0)7 5442 9381

E-mail address: nexus@peg.apc.org

Web page: <http://www.peg.apc.org/~nexus/>

NEW ZEALAND OFFICE - PO Box 226, Russell,

Bay of Islands. Ph: +64 (0)9 403 8193;

Fax: +64 (0)9 403 8196;

E-mail address: nexusnz@xtra.co.nz

USA OFFICE - PO Box 177, Kempton, IL 60946-

0177. Ph: (815) 253 6464; Fax: (815) 253 6454

UK OFFICE - 55 Queens Rd, East Grinstead, West

Sussex, RH19 1BG. Ph: +44 (0)1342 322854;

Fax: +44 (0)1342 324574;

E-mail address: nexus@ukoffice.u-net.com

EUROPE OFFICE - PO Box 372, 8250 AJ Dronten,

The Netherlands. Ph: +31 (0)321 380558;

Fax: +31 (0)321 318892;

E-mail address: Ohegge01@flnet.nl

ITALY OFFICE - c/- Avalon Edizioni, Piazza

Mazzini 52, 35137 Padova.

Ph/Fax: +39 (0)49 912 6006

STATEMENT OF PURPOSE

NEXUS recognises that humanity is undergoing a massive transformation. With this in mind, NEXUS seeks to provide 'hard-to-get' information so as to assist people through these changes. NEXUS is not linked to any religious, philosophical or political ideology or organisation.

PERMISSION-TO-REPRODUCE POLICY

While reproduction and dissemination of the information in NEXUS is actively encouraged, anyone caught making a buck out of it, without our express permission, will be in trouble when we catch them!

Editorial

Welcome to the end of 1997 and the beginning of 1998. As many readers are aware, the next two dozen or so years are heavily marked with the brush of prophecy. Virtually every culture and religion on the planet today has a forecast for the future—with one word being uttered more often than others: "apocalypse".

While the emotional tones of this singular word feel pretty horrifying, it is interesting to note the original meaning. "Apocalypse" literally means "the revealing", "the unveiling" or "the uncovering". Whereas before I would have asked to avoid an apocalypse, now I would embrace one!

As you can imagine, one of the most common questions I get when I'm standing behind our table at various trade fairs and expos is, "Can you tell me about the stories you are not allowed to print?" One of the subject areas I have been "encouraged" not to cover is how the intelligence community is behind the global powder-drug trade. No surprises here, except it does not involve just the CIA: it is global! The Russians, British, Israelis, Irish, Australians, Canadians, Kiwis; you name them, they have never looked after *national* security—only *transnational* security! The money, after being laundered, funds what are known as "black-budget projects", and it is anyone's guess what the agenda for these are. Thankfully there are an ever-increasing number of whistleblowers out there developing a conscience, as you will see from yet another article on the subject of international drug-running in this issue.

Another such subject area is one more sensitive and controversial. It is the subject of the paedophile networks cover-up. Australians have recently been told there are no grounds for an investigation into a "massive paedophile network reaching to the highest levels". Rubbish! Have you noticed the ever-increasing number of missing children, and the ever-increasing number of "inquiries" being quashed from "higher levels" of government and law? Bring on the apocalypse, and may those corrupt people in positions of "respect" be "revealed", "unveiled" and "uncovered"!

You will notice this issue of NEXUS seems to lean towards a predominance of articles and news items that point out another area of society that needs an apocalypse: the area of the suppression of "alternative medicine". The number of people totally cured of cancer, AIDS and other so-called "incurable" diseases increases almost daily—and still the only reaction by the medical and media mafia is to ignore, then deny, and, finally, attack. The Australian arm of the international "therapeutic" drugs network, the TGA, has "leaned" on several of our regular advertisers whom you will not be seeing again. Another advertiser fighting to have the right to bring his product to your attention is Bionic Products (see advert on page 3). In the USA, the UK and Australia there is literally an underground war being waged by people who want to be able to treat themselves and have access to vitamins, minerals, herbs and the like, without having to answer to Big Brother!

Take the author of one such article inside this issue: Dr Sam Chachoua. Since speaking with me over the phone from Mexico, he has not only had death threats, he has someone put three bullets through his window. His crime? He has cured dozens of people suffering from cancer and dozens more with AIDS and "they" don't want him talking about it.

Which brings me to another commonly asked question: "How are you able to cope with all this information, Duncan?" The answer: "Sometimes I don't cope well at all!"—as you can see by the tone of this editorial.

A good friend of mine phoned me the other day and asked me to try to put some good news into the magazine. Well, some good news I *did* find was that the Lord Mayor of Brisbane doesn't want to fluoridate the city water supply, and that the Australian National Health and Medical Research Council has withdrawn its support for dental mercury amalgam.

The rest of the good news is that there are thousands and thousands of people of all races and religions working and praying every day for a better, cleaner, more honest, more peaceful and more loving world. May they live long, and prosper!

Duncan

WARRANTY AND INDEMNITY

Advertisers upon and by lodging material with the Publisher for publication or authorising or approving of the publication of any material INDEMNIFY the Publisher and its servants and agents against all liability claims or proceedings whatsoever arising from the publication and without limiting the generality of the foregoing to indemnify each of them in relation to defamation, slander of title, breach of copyright, infringement of trademarks or names of publication titles, unfair competition or trade practices, royalties or violation of rights or privacy AND WARRANT that the material complies with all relevant laws and regulations and that its publication will not give rise to any rights against or liabilities in the Publisher, its servants or agents and in particular that nothing therein is capable of being misleading or deceptive or otherwise in breach of the Part V of the Trade Practices Act 1974. All expressions of opinion are published on the basis that they are not to be regarded as expressing the opinion of the Publisher or its servants or agents. Editorial advice is not specific and readers are advised to seek professional help for individual problems.

© NEXUS New Times 1997, 1998

Letters to the Editor ...

Not So Sweet on Aspartame

Dear Duncan: Thanks for the informative dissertation on aspartame [NEXUS 2/28, 3/01].

I found out years ago the effects of using aspartame. They ranged from headaches to depression.

Since I was an unsuspecting consumer of this product, I used it every day in coffee and diet drinks. I suffered for years from symptoms that seemed to have no answer, until I was informed that NutraSweet could be the cause.

The symptoms subsided almost immediately after I substituted other sweeteners and stopped drinking diet sodas.

A protest to Searle was useless as the company repeated its claim about its product's safety and approval from the FDA.

I agree with you: aspartame is one of the most dangerous food-additives on the market. It's especially so, considering that the FDA has 'rubber-stamped' its approval.

Truly, Joseph Caughman, USA.

Natural Hormone Therapy

Dear Ed: Just a note to say thanks for the information disseminated by NEXUS on the alternative hormone therapy.

My sister-in-law was being told by the regular medicos that long-term synthetics and probably hysterectomy at 33 were the only course for her after years of problems. My wife sent for the book [*Hormone Heresy*], and my sister-in-law tried out the therapy. She's now pregnant with a much-longed-for second child.

Cheers to everybody in conspiracy land.

Adrian Bailey, 113253.517@compuserve.com

Reverse Speech, Oswald & JFK

Dear NEXUS: This is in regard to David John Oates' piece, "Reverse Speech: Voice of the Inner Self" (4/06, Oct-Nov '97).

While no one knows reverse speech as does Mr Oates—least-ways outside of the world of intelligence, at any rate—he doesn't know diddly-squat about the JFK assassination. He states that in reversing comments made by Lee Harvey Oswald on a radio broadcast two weeks before the assassination, there is this: "Hear them. Wish to kill the President." Then Mr Oates concludes, saying:

"Oswald was talking forwards about the Fair Play For Cuba Committee."

Even students of JFK 101 know that that radio debate was a set-up to create for Oswald a commie-symp legend.

To whom Oswald would have been referring were the CIA operative/spear-carriers in front of the other microphones serving as foils. That's the "them".

This is cleared up easily—lest there be any lingering doubt—in my suggesting to Mr Oates that he go back through his tape files and round up the one I previously sent him. After all, as he says about reverse speech, truth is what it's all about.

Sincerely, Michael Levy, Washington, DC, USA.

Colloidal Silver and the Moon

Dear Duncan: I couldn't help but notice the number of ads relating to colloidal silver in your mag. I thought your readers might be interested in the experiments of Georges Lakhovsky, an engineer, described in 1932.

He found it was possible to sterilise water and other liquids through direct contact with metal conductors. In the case of silver, he found that the effect was different according to the phases of the Moon. During the full moon it could take between 26 to 40 hours to sterilise the water; but four days before the full moon, silver produced the opposite effect: bacterial growth was enhanced. During the waning moon the water was sterilised in from six to seven hours. These experiments have been carried out in two different laboratories, in the Salpêtrière and the Pasteur institutes.

It also interesting that the ancients knew of the connection between silver and the moon. (See Kolisko, *Silver and the Moon*.)

Regards, Bruce Brunson, bhive888@pac.com.au

Evolution or Intervention?

Dear Duncan: I am writing concerning the article in NEXUS 4/05, "The Origin of Our Species: Evolution or Intervention?"

There seems little doubt that aliens came to Earth. Whether they created humanity is still questionable. But what hits hard is

what if we have all lived a lie (or, better say, a deception)? What effect would it have on society? Belief in religion has been very important, and the presence of an omnipresent "God" a contributing factor to success of law. See how many people ask for sins to be cleansed by priests before death? If religion crumbles, the restriction of "sin and you will go to hell" no longer holds. Does it mean more crime in society without religion?

Also, I have read that apart from little aliens with pale skin, the abductees have seen tall, perfect, blond-haired, blue-eyed men. Could they be our descendants talked about in the article—the genetically perfect beings that came to Earth so many years ago? Could the little men be slaves just like we were supposed to be created for, as in the article?

Thanks, Julius Fajardo, Sydney, NSW, Australia, jcfajardo@ultimate.com.au

Microwave-Resistant Bacteria

Dear Sir: We, the public, are led to believe that microwaves are a godsend. They heat our food quickly, allow communications to reach heights undreamed of 30 years ago, are supposed to be safe, and supposed to kill any and all bacteria—pathogenic or not.

Recently I was privy to a little piece of information that (me being the typical consumer) was shocking, to say the least! I was wondering if you could look into the situation and find the real truth, if there is any. The information was this: not all pathogenic bacteria are killed by microwaves. There are a few species that have a mechanism which allows them to survive.

Being a single man and a student, I rely heavily on my microwave oven. It saves me a tremendous amount of time. I also thought I didn't have to worry about bacteria in my food, that the microwaves would kill them. Am I wrong?

R. Downing, Kansas, USA, talyb@terraworld.net

Navy/SAS Antarctic Sortie?

Dear Editor: A family member of mine has recently left for the Antarctic with two ships of the Royal Australian Navy. Their job was to outfit these ships before

they went on this trip as well as going along for the ride.

It's not all that unusual for a ship to sail to the Antarctic, though infrequent. The funny part is that one of the ships is a refuelling vessel, and nobody knows for sure how long they will be gone; "about a month" is all they know.

They have loaded quite an arsenal for this little sortie—enough weapons to fill everybody's hand with something nasty (that is unusual). I'm ex-navy weapons myself. I know what they normally carry.

Is it coincidental that a number of SAS have had quite a deal of training on at least one of the vessels prior to departure? Are they on there now?

This may very well be nothing, although I am sure it is not something quite as simple as "exercising our fishing rights and showing our presence in the area". North of Australia, okay, I don't have a problem. But Antarctica?

If anything comes to light on this I would be grateful to hear of it.

Rick, Australia.

The Global HIV Fraud

Dear NEXUS: Do NEXUS readers realise that "HIV" is a laboratory construct and does not exist? NEXUS Magazine's "Statement of Purpose" opens the door to this censored information: "NEXUS recognises that humanity is undergoing a massive transformation... NEXUS seeks to provide 'hard-to-get' information so as to assist people through these changes."

Not a single scientist has proven the existence of "HIV" as a unique molecular entity. The hypothetical "HIV" has never been isolated as a unique, exogenous retrovirus. The "HIV" test has never been scientifically validated—there is no universal gold standard "HIV" test to prove that one is "HIV-positive". No particle of "HIV" has ever been obtained pure, free of contaminants; nor has a complete piece of "HIV RNA" (or the transcribed DNA) ever been proven to exist. There is no such data proving the origin of either "HIV" proteins or "HIV" antibodies. The rules demonstrating the existence of "HIV" (and retroviruses in general) were never adhered to by those that devised them, nor were they ever validated.

... more Letters to the Editor

NB: Please keep letters to approx. 100-150 words in length. Ed.

NEXUS readers should be made aware of the global "HIV" fraud.

Yours sincerely,
Alex Russell, Researcher,
Continuum magazine, London,
UK, e-mail: contin@dircon.co.uk

Hulda Clark Accolades

Dear Duncan: I'd like to take this opportunity to give you a long overdue thank-you for the fact that I now have a very healthy husband. After almost two years of being really sick, and with nobody able to help him (we tried it all, traditional and alternative), I read your review of Hulda Clark's book, *A Cure for All Cancers*, in a NEXUS magazine [3/01] hanging around at work.

We followed all the procedures she recommended and I have to say I think all of us who live in the so-called "civilised" world can benefit from them. She has the Rolls-Royce of liver cleanses.

You have my undying gratitude. Keep up the good work.

Yours faithfully, Judit E.,
Bullaburra, NSW, Australia.

Circumcision Madness

Dear Sir: I would like your readers to know about the medical deception behind the practice of male infant circumcision. Doctors have for decades 'conned' parents into believing male genital mutilation, euphemistically called "circumcision", is a simple surgical procedure with no risks or disadvantages and offers potential health benefits.

The alleged health benefits have been disproven; still we see doctors using these disproven myths to justify the procedure. By contrast, evidence of long-term physical/psychological harm from circumcision is well-documented and continues to grow worldwide.

All pro-circumcision literature emanates from the USA where the foreskin industry has flourished since the 1930s. Today, infant circumcision continues for the monetary gain of doctors, appliance manufacturers, skin banks, researchers, pharmaceutical companies and sexual health clinics. Male infants have, in fact, become forced organ donors!

According to statistics compiled by Demographics International, only 15 per cent of the world's 2.68 billion males are circumcised.

Parents should remain forever vigilant in protecting their children's rights, health and well-being and not fall victim to the 'scare tactics' employed by those who perpetuate this archaic and harmful surgery on consenting minors.

Yours sincerely, John S.,
Belmont, NSW, Australia.

Princess Diana Conspiracy?

I am the web master of the conspiracy theory discussion board which is dedicated solely to the pursuit of the truth of what really happened in the Pont de l'Alma tunnel on 31 August 1997.

This web site was the first to dedicate itself to this topic (launched within three hours of the announcement of Princess Diana's death) and is also the most heavily trafficked. We have had to move our web site several times because of Internet sabotage; however, the combined counters show that we have had close to 450,000 hits in just eight weeks.

I am not a fringe radical. I have never previously involved myself with matters of conspiracy. I am, in fact, a well-educated professional and a writer, and would say that I am considered a person of reason by my friends and associates.

The same is true of the regular posters to this discussion board. Included among them are doctors, lawyers, architects, engineers, nurses, university professors, business executives and journalists. And, almost to a person, they post or tell me in e-mail that they have not previously involved themselves with conspiracy theories of any sort. Those who post here are not "fringe lunatics" as the Press attempts to portray about conspiracy theorists in general. You will not find people here who hold to the theory that Elvis lives and that man's lunar journeys took place in a Hollywood sound stage.

What you have here is a microcosm of global society, students and housewives among them, who believe that we are not being told the truth about what happened in the tunnel that night.

On the night that Diana died, there was speculation here that she and Dodi al-Fayed had gotten engaged that night. Yet the scoffers scoffed and the scorners scorned. Two or three weeks later

it was disclosed that Dodi had given Diana an engagement ring that very night.

For weeks we questioned the involvement of another car, and the scoffers scoffed and the scorners scorned. Finally, the same French investigators who had assured the public that no other vehicle had been involved in the crash, asserted their belief that in fact a Fiat Uno had been involved.

Item after item that has been questioned and analysed here, has eventually come into play in the official investigation.

The Press and the governments of Great Britain and France have underestimated who bears the sentiments found on our discussion board. From the e-mail I receive, and discussions with ordinary people everywhere I go, I find almost no one who is satisfied with what the public has been told about the cause behind the crash and how the passengers of the Mercedes died. Even those who believe it was an accident (who seem to be far and few between) do not believe the incredulous accounts of Henri Paul's drunkenness which decry the Ritz video footage and even Trevor Rees-Jones' accounts of his demeanour just before the accident.

And they don't buy the accounts of a doctor who treated her at the scene—and who amazingly happened to have an oxygen canister in the trunk of his car—but who did so without ever looking at her face to know who she was.

Diana, from all accounts and photographs, was completely accessible through the rear doors of an amazingly unscathed rear cabin (pre-"jaws of life"), yet this experienced trauma physician didn't feel it important to check her pupils and to ensure that her mouth and throat were clear of blood and vomit before administering oxygen and leaving the scene. And with a crowd of paparazzi around, and Romuald Rat at the car even before the doctor, he (the doctor) never knew whom he was treating? Perhaps it is all true, but people of reason demand then to know the truth behind such seemingly irresponsible treatment.

And there are other things... We have seen *Dateline's* exclusive photos of the car before the "jaws

of life" cut into it. The back cabin, the entire rear compartment, looked as intact as a car that had just been driven off a dealer's lot. The trunk, roof and rear doors looked unscathed (not like a car that had rolled, as has been reported). Moreover, they were clearly unscathed enough for either rear door to be opened normally, which paparazzo Romuald Rat did. Why then did it take more than two hours to remove Diana from the car? Clearly, she did not have to be cut out, as may have been the case with Trevor Rees-Jones.

And why did it take more than 40 minutes to drive to a hospital six miles away with the ambulance incredibly losing its police escort during that drive? Yes, we have heard the unsatisfactory explanation of the ambulance pulling over to administer adrenaline to Diana's heart. It is just that the doctors who participate in this web site tell us that it was these delays that cost Diana any chance she had of surviving.

There are hundreds of inconsistencies that have been discussed, debated and analysed here. Many may be readily explainable. But there are too many of them, way too many when coupled with contradictions—from "there was no other car involved" to "there was a black/blue/red/white/yellow Fiat Uno involved".

Stop and ask yourself, if these types of questions and inconsistencies loomed over an investigation into the death of your own child or spouse, would you be satisfied? I think not.

Once upon time, in the modern age in which we live, a charismatic leader convinced an adoring public of his noble purposes. He was above question and the rumour-mongers were simply "fringe lunatics"—that is until his infamous *Krystallnacht*, the night that Hitler's goons awoke a sleeping Germany with the "breaking of glass".

Demosthenes said, "There is one safeguard known generally to the wise, which is an advantage and security to all, but especially to democracies as against despots. What is it? Distrust."

Web site: <http://www.internet-inquirer.com>; E-mail: conspiracy@mailexcite.com

HARD-ROCK MUSIC CREATES KILLER MICE!

David Merrell, a high school student from Suffolk, Virginia, has won top honours in regional and state science fairs for his experiment involving mice, a maze, and hard-rock music.

After establishing a baseline of about 10 minutes for the mice to navigate the maze, David started playing music 10 hours a day, then put the mice through the maze three times a week for three weeks.

His findings: the control-group mice, which did not listen to any music, were able to cut five minutes off their time; the mice that listened to classical music cut 8½ minutes off their time; and the mice that listened to hard-rock music took 20 minutes longer to navigate the maze.

David said, "I had to cut my project short because all the hard-rock mice killed each other... None of the classical mice did that at all."

(Sources: *Washington Times*, 2 July 1997; reported in *Blazing Tattles*, Aug-Oct 1997)

EPA SCIENTISTS VOTE AGAINST FLUORIDATION

A copy of this letter, sent to the Citizens for Safe Drinking Water, San Diego, California, was recently faxed to us:

"I am pleased to report that our union,



Local 2050, National Federation of Federal Employees has voted to co-sponsor the California citizens' petition to prohibit fluoridation of which your organisation is the sponsor. Our union represents, and is comprised of, the scientists, lawyers, engineers and other professionals at the headquarters of the US Environmental Protection Agency here in Washington, DC...

"It is our hope that our co-sponsorship will have a beneficial effect on the health and welfare of all Californians by helping to keep their drinking water free of a chemical substance for which there is sub-

stantial evidence of adverse health effects and, contrary to public perception, virtually no evidence of significant benefits...

"Our members' review of the body of evidence over the last eleven years, including animal and human epidemiology studies, indicate a causal link between fluoride/fluoridation and cancer, genetic damage, neurological impairment and bone pathology. Of particular concern are recent epidemiological studies linking fluoride exposures to lower IQ in children.

"As professionals who are charged with assessing the safety of drinking water, we conclude that the health and welfare of the public is not served by the addition of this substance to the public water supply..."

(Source: Letter from J. William Hirzy, PhD, Senior Vice-President, National Federation of Federal Employees, to Jeff Green, Citizens for Safe Drinking Water, dated July 2, 1997)

SCIENTISTS AGREE: MARGARINE IS BAD FOR YOU!

Saturated fats aren't the only no-nos in a heart-healthy diet. A new study from Brandeis University, the University of Malaya and the Palm Oil Research Institute of Malaysia has found that substitute *trans*-fatty acids—made from partially hydrogenated unsaturated vegetable oils—are even worse.

Not only do *trans*-fatty acids, which are often found in margarine, raise levels of 'bad' LDL cholesterol in the blood, as do animal fats, they also lower levels of 'good' HDL cholesterol.

(Source: *Scientific American*, August 1997. See also our article, "Margarine, Fatty Acids and Your Health", in NEXUS 4/02.)

THE MOST CARCINOGENIC CHEMICAL EVER FOUND

Japanese scientists suspect that a chemical in the exhaust fumes of Diesel engines may be the most carcinogenic ever found, and the cause of a rise in urban lung cancers, according to a report in the October 1997 issue of *Environmental Science and Technology* (vol. 31, p. 2772).

The compound, 3-nitrobenzanthrone, had the highest-ever score on a standard test for cancer-causing potential of toxic chemicals.

WELL? REDUCE
GREENHOUSE
EMISSIONS!



... GLOBAL NEWS ...

"I personally believe that the recent increase in the number of lung cancer patients in vehicle-congested areas is closely linked with respirable carcinogens such as 3-nitrobenzanthrone," said Hitomi Suzuki, a chemist at Kyoto University, who led the study.

When Suzuki tested the compound on a strain of salmonella he found that it caused more mutations than 1,8-dinitropyrene, the previously most powerful known mutagen.

Although both compounds are found only in minute quantities, they are so dangerous that "it is easily understandable that they would contribute considerably to the total mutagenic activity of Diesel exhaust particle extracts," Suzuki added.

He has called for stronger limits on the loads that Diesel trucks can carry because there are more emissions from engines under heavier loads.

(Source: *New Scientist*, 25 October 1997)

UK HOSPITAL TOLL OVERTAKES ROAD DEATHS

Hospital infections account for more deaths per year in the UK than road accidents or suicides. At any one time, 10 per cent of hospital in-patients are suffering from an infection contracted since they were admitted. These infections cause 5,000 deaths a year and contribute to a further 15,000.

The findings are released in a new book on Hospital Acquired Infections (HAI), published by the Office of Health Economics which studies the financial aspects of health care. The study finds the most common infections contracted from hospitals are in the urinary tract, the lower-respiratory tract and surgical wounds.

The report also says that up to a third of HAIs could be prevented.

(Source: *The Independent*, UK, 16 September 1997)

CANNABIS CURES BLINDNESS!

Sue Arnold, a respected journalist and writer for the *Observer* for 26 years, is registered as blind. A sufferer of retinitis pigmentosa, an hereditary eye condition, she recently discovered—by accident, at a dinner party in Battersea—that smoking cannabis brought back her sight.

Since that night, Sue has been spearheading a campaign to legalise cannabis for medicinal use in the UK.

(Source: *Evening Standard*, UK, 16 September 1997)

ELECTROMAGNETIC HOT-SPOTS MAKE CARS GO CRAZY

Many of Sydney's new cars have become vulnerable to various electromagnetic field "hot-spots", according to Phil Scott, Motoring Editor of the *Sydney Morning Herald*.

Symptoms include cars jamming on their own brakes, doors locking and gears shifting on their own, and engines shutting down completely.

The cars at most risk are a relatively small number of newer cars with inadequate "immunity" built into the electronic systems which control engines, brakes, transmissions and features such as central door-locking, cruise control and air conditioning. Airbags can also be affected.

Automotive failures are also well-known to RFI Industries, an independent testing laboratory in Melbourne. Dick Davies, manager of the company's electromagnetic compatibility and interference laboratories, says, "Of course the automotive world is closed-mouthed, like the medical world.

"We put these malfunctions into different classes. A fuel gauge that doesn't work when you're on the mobile phone is a 'grade one'. A 'grade two' might be the windshield wipers going off. Startling, yes, but unlikely to cause an accident.

"Grade three' could be the electric seat repositioning itself while you're driving. That could, perhaps, cause an accident. Then you go through to the 'grade fives', the catastrophic ones. You might be dri-

ving down the Hume Highway at 120 km/h and the microprocessor says 'stop the left front wheel'...or maybe the cruise control jams."

Needless to say, Australia is looking into standards on electronic immunity.

(Source: *The Sydney Morning Herald*, 13 October 1997)

UK GULF WAR VETS BLAME UNTESTED VACCINES

Armed Forces Minister John Reid, probing mysterious ailments suffered by British Gulf War veterans, said the troops were given vaccines that were not licensed in the UK. The soldiers, due to the threat of biological and chemical attack from Iraq, were given a mixture of anthrax and pertussis vaccines despite warnings from health department officials.

Reid told reporters: "I am committed to doing all I can to get rid of the distrust which has built up over the years between the Ministry of Defence and those who served their country in the Gulf."

Veterans campaigning for official recognition of "Gulf War syndrome" (GWS) believe their illnesses have resulted from a cocktail of chemicals they were given during the war. The symptoms include asthma, chronic fatigue, depression and skin ailments. About 51,000 British troops served in the war and up to 4,000 veterans and members of their families are ill.

(Source: *The Guardian Weekly*, w/e 9 November 1997)



WITHOUT INFORMED CONSENT

On 19 November 1996 something happened in Strasbourg, France, which could fundamentally remove many of the rights of patients. It had no public airing beforehand, and has been little reported on ever since.

After marathon discussions, the Committee of Ministers of 39 European Union member states adopted the Convention on Human Rights and Biomedicine. This allows for future drug use and other medical trials to be carried out on potentially huge numbers of people, possibly without their consent.

Those particularly at risk include the mentally ill, who are deemed not to be able to give their consent; those with diseases for which there is no "known" cure (i.e., AIDS, cancer, CJD); people who are in a coma; those needing emergency treatment; and, perhaps most worrying of all, children.

Although the convention applies only to EU member countries, the US Food and Drug Administration (FDA) simultaneously, and very quietly, changed its rules to be almost identical to those of the Strasbourg Convention. These new rules also mean that some groups of people may be involved in medical research programs without their knowledge or consent.

Under the guise of individual "protection", the Convention says that in certain situations "general interests" will take priority over those of individuals. There is even the provision for organ removal from a living person, without consent, for trans-

plant purposes in "exceptional circumstances".

(Source: Doris Jones, *What Doctors Don't Tell You*, September 1997)

POLICE SPYING ON CITIZENS IS RAMPANT IN VICTORIA

Early October 1997 saw many Australians stunned to learn that even our fair country, the state of Victoria in particular, has its own secret police force. What shocked most people was the extent of surveillance on a wide range of society. Environmental groups, senior citizens' groups, community radio stations, journalists, nurses, women's groups, musicians, politicians, AIDS groups, church leaders and church groups—no one, it seems, has been exempt from ongoing scrutiny. Is this how we want our taxpayer dollars spent?

Equally shocking was that most politicians had no idea that this was going on, and those who did fully supported it!

In Victoria, the "secret police" is called the Protective Security Intelligence Group, and it has been infiltrating its members into the abovementioned organisations for years. One can only guess at the size of their accumulated wisdom by listening to the infighting and politics that are rampant inside all these community groups.

The undercover police at one community radio station, 3CR, were so diligent in turning up for their volunteer work that they became entrusted with organising fund-raising, deciding on programs to be broadcast, and even participating in the broad-

casting of programs they helped to make!

As more details came to light, many who found their names on "the list" decided to turn the tables and follow and monitor the movements of the Victorian "secret police". They are not amused!

(Sources: *The Sydney Morning Herald*, *The Age*, 6, 7, 8 October 1997)

POLICE ENTRAP UFO BUFFS!

The front page of the *Evening Argus*, from Sussex, England, proudly boasts how their own Crimebusters initiative has helped local police catch offenders.

Apparently the local bobbies set up a fake UFO sighting using four colour-filter halogen lights and then broadcast hoaxed messages over the police band of the CB radio.

Carloads of people turned up to the broadcasted location, only to be interrogated by the boys in blue—not the ones in grey, green or black! Two disappointed UFO-hunters had their scanning equipment confiscated for illegally using scanners to listen in to police messages.

Crime in Sussex must be at an all-time low for the local paper and police to devote such resources to catching two harmless UFO buffs.

(Source: *Evening Argus*, 12 September 1997)

FBI SPIED ON EX-BEATLE AND LIVELY PARROT!

If you thought Victoria's secret police or the local bobbies in Sussex were keen, forget it. The ever-vigilant FBI has finally surrendered most of its files on John Lennon, revealing an investigation which ranged from reports on his contacts with anti-war protesters to the political leanings of a friend's parrot.

The files, which the FBI fought for 16 years to keep secret on the grounds of "national security", reveal agents zealously investigating the former Beatle, opponents of the Vietnam War and black militants.

"These documents show the FBI investigation was conducted in the manner of the shabbiest tabloid journalist," said Mr Mark Rosenbaum, a lawyer acting for Professor Jon Weiner who sued the FBI for the release of the files.

"They show the FBI had nothing better to do than record the utterances of a parrot and indulge in gossip and innuendo about rock musicians who happened to take political stances."

Under legal pressure, the FBI surren-

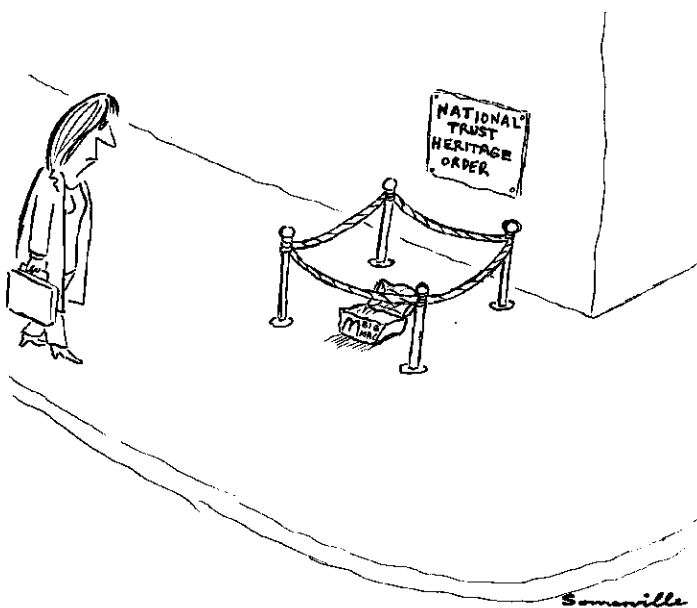

dered the 40 pages of documents and agreed to pay Professor Weiner, the author of a book on Lennon, US\$200,000 to cover his legal costs.

The documents contain many pages of trivial information, including a report in March 1972 that a woman named Linda had taught her parrot to interject with the words "Right On!" whenever a conversation became lively.

(Source: *The Sydney Morning Herald*, 27 September 1997)

MASONS ABUZZ OVER ELECTRONIC HANDSHAKES

The Freemasons' secret handshakes are about to go electronic. Finnish company Creativesco is patenting "the Kinsmen" (WO 97/24627) which silently alerts members of a secret society to each other's presence.

Transponders are disguised as pendants, watches or badges and emit an agreed code-word while searching for a match in the area. When a match is found, each device sends out an acknowledgement and alerts its owner by vibrating silently.

Transmission is low-power, so the alert only works over short distances. After the signal, fellow members can make visual contact with pre-arranged gestures and expressions. The same system could help strangers identify each other in crowds.

(Source: *New Scientist*, 27 September 1997)

MAD COW DISEASE JUMPS THE SPECIES BARRIER

According to some researchers, the new variant-CJD (Creutzfeldt-Jakob disease) is shaping up to be the plague to end all plagues.

Research studies published in *Nature* (vol. 389, 2 October 1997) reveal that the agent that causes bovine spongiform encephalopathy (BSE), or "mad cow disease", has jumped the species barrier.

Technically speaking, this agent is still undefined, but the scientific establishment, in its infinite wisdom, has decided that "prion" protein agents are most likely behind it all. In an attempt to establish that prions are indeed the new nasties, the Nobel Prize for Medicine was recently awarded to Dr Stanley Prusiner for his "discovery" of prions.

(Source: *New Scientist*, 4 October 1997. For more info, see our "mad cow" article this issue, plus our review of *Deadly Feasts*; or visit the web site, www.madcow.com)

SEEDS OF DESTRUCTION IN MONSANTO CONSPIRACY

Monsanto, that company that health and freedom activists love to hate, has embarked on one of the most extraordinary and ambitious corporate strategies ever launched. The story begins with a single chemical, glyphosate. Sold to farmers and gardeners as "Roundup", it is the world's biggest-selling herbicide, earning more than US\$2 billion last year alone. The company's patent on Roundup runs out in 2000, but, far from sowing corporate catastrophe, this event seems likely to enhance Monsanto's market value.

For the past 10 years it has cleverly been developing a range of new crops, genetically engineered to resist glyphosate. Spraying with Roundup does not harm these crops, but destroys all the weeds that compete. New patent legislation in Europe and the US allows Monsanto to secure exclusive rights to their production.

The first "Roundup-Ready" plant Monsanto released was a genetically engineered soybean. Between 50 and 60 per cent of processed foods contain soya, so the potential market is enormous.

Alarmed at possible increases in the use of herbicides, as well as the health effects of genetically engineered crops in general, environmentalists and consumer groups in Europe started calling for products containing the new beans to be clearly labelled. But in the US, Monsanto insisted that it would be impossible to keep Roundup-Ready soybeans apart from ordinary ones.

As the new beans were snapped up by growers in the US, Monsanto began an extraordinary round of acquisitions, buying shares in seed and biotechnology companies worth nearly US\$2 billion in the past 18 months alone. Among its purchases are companies which produce the famous "Flavr-savr" tomato, own the US patent on all genetic manipulations of cotton, and control around 35 per cent of the germplines of American maize.

Monsanto is now experimenting with new rice, maize, potato, sugarbeet, rape and cotton varieties. It has been suggested that within a few years all the major staple food crops will be genetically engineered. The new products are so attractive to many farmers that Monsanto has managed to get them to sign away their future rights to the seed they grow, and allow the company to inspect their fields whenever it wants.

Monsanto's new crops could not have become commercially viable without major legislative change. As members of the trade lobby Europabio, Monsanto and the other big biotech companies have mastered the legal climate in which they operate. Despite significant public opposition, in July Europabio managed to persuade the European Parliament to adopt a new directive, allowing companies to patent manipulated plants and animals.

Researchers and lawyers from Monsanto already occupy important posts in the US Food and Drug Administration which regulates the food industry. Only the New York Attorney-General's office has taken the company to task, forcing it to withdraw ads claiming that Roundup is biodegradable and environmentally friendly.

But Monsanto has been most successful when appealing to multilateral bodies. Last month, the World Trade Organization (WTO) confirmed its ruling that the European Union can no longer exclude meat and milk from cattle treated with Monsanto's bovine growth hormone, despite protests from farmers, retailers and consumers.

Biotech firms are now trying to persuade the WTO to forbid the labelling of genetically engineered foods. Any country whose retailers tell consumers what they are eating would be subject to punitive sanctions.

With astonishing rapidity, a handful of companies is coming to govern the global development, production, processing and marketing of our most fundamental commodity: food. The power and strategic control they are amassing will make the oil industry look like a corner shop.

More successfully than any other lobby, they are inhibiting the two remaining means of public restraint on their activities: government regulation and genuine consumer choice.

This may be the first and last chance we will get to tell the biotechnology companies what we think about their re-engineering—of both the stuff of life itself and the means by which it reaches us.

(Source: Reported by George Monbiot; published in *The Sydney Morning Herald*, 20 September 1997 and *The Guardian Weekly*, w/e 28 September 1997)

From Mad Cows to Humans **THE NEXT GLOBAL PLAGUE**

*By underestimating
the threat and not
taking action
sooner over the BSE
and CJD crises,
agricultural and
health authorities in
Britain and Europe
may have
unleashed a
potentially global
and fatal epidemic.*

by Lynette J. Dumble, PhD, MSc
©1997

Senior Research Fellow
History and Philosophy of Science
University of Melbourne
Parkville, Victoria 3052, Australia
Telephone: +61 (0)3 9344 6668
Fax: +61 (0)3 9344 7959
E-mail: lynette@myriad.unimelb.edu.au

ACROSS THE SPECIES BARRIER—AND NO CURES IN SIGHT

Speaking from Washington, DC, in October 1997 after hearing of his Nobel Prize win for discovering the role of molecules known as "prions" in the invariably fatal brain illnesses such as "mad cow disease" or bovine spongiform encephalopathy (BSE) in cattle, and Creutzfeldt-Jakob disease (CJD) in humans, Dr Stanley Prusiner from the University of California predicted that the first drug therapy, which would not necessarily be a cure for BSE or CJD, was at least five years away.¹

At the same time, on the opposite side of the Atlantic, the post-mortem of Chris Warne, a 36-year-old fitness fanatic from Derbyshire, England, revealed that he was the 21st victim of the new variant of CJD which had spread from BSE-infected cattle to humans via the food chain.

Only 18 months earlier, a British House of Commons admission that BSE-infected meat had probably caused the CJD deaths of 10 youthful Britons left the British meat industry in tatters.² Since then, the history of BSE has gradually unfolded to reveal a brain-dead imperialism, one which, while blinded by its own arrogant greed to inflate market profits, has treated public and, indeed, world health with gay abandon.

Formerly a rare disease which affected less than one per million in most countries, one worst-case scenario predicts that BSE-infected meat will push the incidence of CJD in humans to claim 10,000 British lives by the year 2000, and a further 10 million by the year 2010. Another predicts that half the British people, some 30 million, will be left brain-dead by CJD. As Chris Warne's mother commented, her son was a health-conscious sportsman, but "*after winning medals in March, by July he couldn't stand on his feet, and by October he was gone*".

A CJD epidemic of these proportions largely defies contemplation, but at the same time it raises important questions of whether nature or human error was responsible for the unprecedented assault of CJD and BSE on humans and animals, and whether the public health implications will, at best, be restricted to Britain and her European cronies, or, at worst, become a global disaster.

Faced with a worldwide boycott of British beef, millions of cattle destined for cremation, and BSE emerging in cattle all across Europe, authorities have disenchantingly persisted with face-saving reassurances, the majority of which are disproven with monotonous regularity.

In keeping with the 1960s to 1985 medical mayhem which turned infertile women and short-statured children into human incubators of CJD with injections of hormones harvested from the pituitary glands of human cadavers, mad-cow globalists view Third World countries as a dumping-ground for BSE-infected meat in their thrust to salvage some cash from the chaos.

Unlike the malignant twists of nature, ranging from bubonic plague through to potato blight, which have killed masses throughout the ages, both the beef and pituitary hormone CJD crises were manmade. Scrapie, the sheep equivalent of BSE and CJD, has been around for more than two centuries. Somewhat differently, human spongiform encephalopathy was unheard of before two German physicians, Creutzfeldt and Jakob, independently reported the initial cases in the 1920s. BSE, too, was unheard of until a decade after cattle began to be fed the protein-rich remains of scrapie-infected sheep to accelerate their growth.

Until the BSE crisis came to a head in 1996, there was no concerted effort to find a diagnostic screening test to identify CJD/BSE infection, and to this day there is no known

medication which can cure or allay the cruelty of human or animal death from the diseases.

In humans, outward warning symptoms only emerge after a prolonged incubation period that, in iatrogenic cases which have occurred as a result of human pituitary growth and infertility hormone injections or contaminated surgical materials, has ranged from as few as two to as many as 40 years.

By that stage, the agent of CJD has already turned the brain into the sponge-like mass that led this group of diseases to be classified as "spongiform slow-virus disorders" in the first instance. Death may be a welcome escape from the involuntary jerking motions which accompany CJD which, while silently eating away at the brain over years, has robbed humans of their every means of communication—the ability to hear, see and speak. Gone, too, is the understanding of written and spoken native language, and with it every scrap of dignity.

Similarly, BSE has no respect for cattle decorum, and a furnace is the fate of confused and trembling animals that the disease has deprived of their own legs on which to stand.

TRACING THE TRANSMISSION ROUTES OF BRAIN DISEASES

The original lesson about the infectious nature of these brain diseases came from a 1934 vaccine catastrophe in the UK which brought scrapie, or "mad sheep disease", to almost 5,000 out of 18,000 lambs within two years of their immunisation against louping-ill virus infection. Tracing back, scientists discovered that the vaccine serum was prepared from a number of lambs whose dams had subsequently developed scrapie, but the significance of scrapie passing vertically from ewes to their lambs, and horizontally from lamb to lamb by virtue of the vaccine injections, was kept from international eyes by a series of egotistical carry-ons which prevented the data from reaching the pages of the scientific literature for a further 15 years.³

By then, as the 1950s dawned, mad sheep disease was shown in the United States to jump the species barrier when a scrapie-infected food supplement brought a similar brain illness to farm-raised mink in 1947.⁴

By this stage, the medico-scientific fraternity was intensely preoccupied with another incurable brain illness, kuru, which had reached epidemic proportions amongst the Fore people living in the highlands of New Guinea. Anthropologists from the University of Adelaide unravelled a chain of events to trace the origin of kuru back to the reverent consumption of deceased tribal members' bodies. Kuru was essentially eradicated by New Guinean authorities acting in 1959 on the anthropological clue to outlaw the eating of human flesh. However, the 1976 Nobel Prize went to American scientist Carleton Gajdusek for his experiments demonstrating that injections of kuru brain (1967) and CJD brain (1969) reproduced similar illnesses in chimpanzees.⁵ Gajdusek

was placed behind bars in 1997 after being found guilty of molesting one of the numerous New Guinean youths he has sponsored into the United States over the previous 30 years; however, his research did put an end to ideas that species barriers were an impediment to the spread of this type of disease.

Two neuroscientists, Laura and (the late) Eli Manuelides, from Yale University in the US, went on to illustrate by 1975 that injections of human blood, like injections of brain taken from kuru and CJD victims, transmitted the disease across the

species barrier to laboratory animals.⁶ Their prophetic, but unheeded, message implied that blood was the vehicle that carried the agent of CJD around the body until it chanced upon an hospitable residence like the brain. This meant that the blood route was the key to the transmission of CJD from a primary host to a secondary host. As distinct from infections such as influenza (which is caused by an airborne virus), but in parallel with AIDS and hepatitis B (which are caused by bloodborne viruses), this indicated that recipients exposed to human pituitary gland hormone injections, or to blood or organ transplants from a donor with CJD, risked becoming secondary CJD hosts once contagious material entered their bloodstreams. Similarly, as the UK Government admitted on 7 October 1997,¹ humans infected with the new variant of CJD coming from BSE-infected meat may spread their CJD via blood donation, thereby hastening the globalisation of the European mad-cow dilemma.

Even as the understanding of spongiform encephalopathy increased, various human pituitary hormone programs in countries such as Australia, France, New Zealand, the United Kingdom and United States were attracting hefty government sponsorships. Few of the programs' stalwarts caught on to the implications of the Manuelides' experiments, and unsuccessful attempts between the years of 1978 and 1982⁷

...humans infected with the new variant of CJD coming from BSE-infected meat may spread their CJD via blood donation, thereby hastening the globalisation of the European mad-cow dilemma.

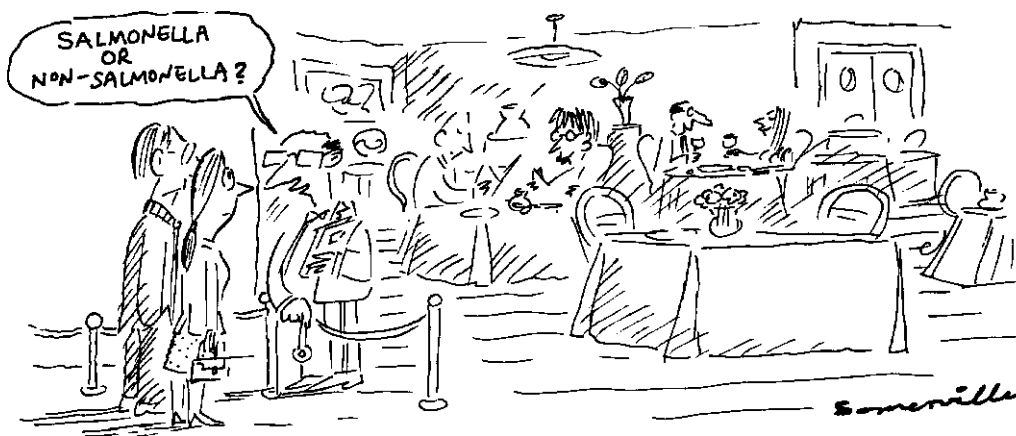

to filter the CJD agent out of the pituitary hormones being injected into unsuspecting short-statured children and infertile women were left to one of this era's rare visionaries, British scrapie expert Alan Dickinson.

At about the same time, a British Royal Commission on Environmental Pollution in 1979 raised the possibility that the unregulated cycling of protein-rich sheep remains back into animal feed might spread scrapie to cattle, as it had done to farm mink in the US three decades beforehand, via the oral route.

At the same time, too, in the push to meet the insatiable demand for more and more human pituitary hormones, India, the world's second-most-populous country, became a Mecca for pituitary-gland harvests. Literally millions of pituitaries were harvested from cadavers in the subcontinent and sent to government laboratories back in Europe and North America. The promised repayment in kind—namely, with a supply of extracted growth hormone to treat short-statured children in India—simply became another broken imperialist promise, but one which probably accounts for India's enviable position today of remaining a CJD-free country.⁸

By 1985, the first of the fatal legacies of this form of medical madness emerged with four cases of CJD in human pituitary growth hormone-treated children.

Programs were immediately halted in most countries, the notable exception being France where the growth-hormone treatment of children continued—based on the haughty assumption that the purity of the French hormone-extraction process accounted for the absence of a single case of CJD to that point in time. Four years later, in 1989, during which time the number of French children at risk of growth-hormone-related CJD had practically doubled, the first French children fulfilled that tragic legacy. In 1993, those responsible for this travesty were threatened with manslaughter charges. By 1997, France had half of the world's 100-plus cases of pituitary hormone-related CJD.⁹

Although the general elitism of human-pituitary programs restricted this brand of medical madness to North America, Europe and Australasia, Third World children and women did not altogether escape the insanity of applying Frankenstein medicine to social conditions. A medical report in 1991¹⁰ linked the CJD death of a young Brazilian man, like those of five youthful New Zealand men and women,¹¹ with a childhood treatment involving pituitary growth hormone obtained from the US.

Unfortunately, the fate of women in Mexico City whose breasts were injected with US pituitary hormones in an appalling experiment¹² to increase the volume of milk in lactating mothers (some already pregnant again) will probably never be known.

The opportunity to contain the CJD legacy of pituitary-hormone injections went begging, as blissfully unaware recipients risked spreading their legacy via blood donation. Similarly, the possibility that pituitary-hormone recipients may have transmitted their CJD legacy to their children was totally cast aside.

Oddly, although the entire concept of blood-transfusion-related CJD was publicly dismissed by health authorities, by 1987 all US and New Zealand registered recipients of pituitary growth hormone were advised not to donate blood and organs. It took until 1992 for Australian and British blood banks and transplant programs to follow suit, with the result that the Australian and British general communities were exposed to the risk of secondary CJD transmission for five years longer than their American and New Zealand counterparts.

Somewhat inexplicably, too, despite the theory of blood-transmitted CJD being considered unproven in humans, 1995 and 1996 actions indicate that authorities have finally opened their minds to the public health implications of the Manuelides' experiments. Canadian authorities spent C\$15 million in 1995 to withdraw pooled plasma, already in the process of being transfused to thousands across the country, on the grounds that it contained a donation from a man who had subsequently died of CJD.¹³ Similarly, in 1996, New Zealand authorities bit the bullet under the weight of public pressure and quarantined blood products which had been contaminated by a donation from a CJD-infected donor;¹⁴ and British blood banks increased their precautionary measures with an extended questioning routine designed to screen out donations from parents, siblings and children of CJD victims.¹⁵

British microbiologist Steven Dealler estimates that CJD-infected blood may reach as many as 60,000 recipients each year,¹⁶ but the years-long incubation time preceding CJD symptoms increases the difficulty of linking a blood transfusion recipient's CJD with a donor source. It falls within the realms of possibility that secondary CJD in a transfusion recipient may appear years in advance of the primary CJD in a blood donor, and evidence of blood-transfusion-transmitted CJD was dismissed as anecdotal until 1996, when the case of CJD in a liver transplant recipient was, after the liver donor had been cleared, traced back to a CJD-like illness in one of the blood donors.¹⁷

MARKETPLACE MADNESS

One year after the first cases of pituitary growth hormone-related CJD in 1985, the first of the animal-protein-fed cattle came down with BSE.¹⁸

Advisory committees were set up around the world, but none with the foresight to include public health experts trained to weigh policy in terms of both best and worst predictions. Instead, for the next 10 years authorities seized every chance to preserve the reputations and careers of eminent politicians, physicians and scientists, and managed to allay public anxiety by keeping news of their bungles out of the media. Public and animal health ran a very poor second to the market pressures¹⁹ which saw cattle transformed from BSE-free herbivores into BSE-infected carnivores by a nonregulated protein diet. In fact, even as BSE emerged in protein-fed British cattle in 1986, scientific advice that the epidemic could best be contained by compensating farmers for the immediate destruction of the 10,000-odd infected cattle was dismissed because of budgetary concerns.

...authorities seized every chance to preserve the reputations and careers of eminent politicians, physicians and scientists, and managed to allay public anxiety by keeping news of their bungles out of the media.

Following the 1988 ban on scrapie-contaminated animal feed, the BSE epidemic was claimed to be under control. According to authorities, the peak 1992 weekly average of 700 new cases of BSE dropped to 70 cases per week in 1996. At the same time, the notion of control is contradicted by the BSE in some 27,000 cattle born after the 1988 ban. Rather, these figures, together with the 60 per cent of 1996 cases occurring in cattle born post-1988, indicate that pre-feed-regulated cattle have passed BSE onto their calves.

Like the theory of bloodborne CJD in humans, earlier suggestions²⁰ that the BSE epidemic in cattle was maintained by maternal transmission were dismissed and at times ridiculed, until a 1996 study proved otherwise.²¹

Erring on the side of caution has invariably been forgotten in the brain-dead politicking underpinning the BSE/CJD debacle. As an example, the British Ministry of Agriculture, Fisheries and Food (MAFF) sabotaged a 1990 Brussels ruling designed to prevent the spread of BSE across to the European mainland.²²

MAFF instead issued civil servants with secret orders to skip the computer-vetting of calves set for the lucrative saleyards of European Union (EU) member countries. As a result, there were no checks to determine whether some two million veal calves sold to the EU between 1990 and 1995 were born to BSE-infected cows or not.

Even the computer tracing of the BSE parentage of some 2,000 cattle sold for foreign breeding after 1990 is untrustworthy, partly because of MAFF's skulduggery, and partly because the sales involved animals that were too young to reveal symptoms of BSE infection—and there is no diagnostic screening test for BSE to establish which cattle are infected and which are free of BSE.

An estimated 700,000 BSE-infected cattle entered the human food chain, chiefly because the animal's slaughter age (usually three years) pre-dated the average age (five years) at which they would show signs of BSE infection.²³ For the same reason, there is simply no way of knowing the number of breeding stock exported to the four corners of the globe before their sire's or dam's BSE was subsequently uncovered.

Britain was not alone in the cover-up of the BSE scandal. In September 1996, the French newspaper *Libération*²⁴ revealed that a memorandum from French official Gilbert Castille had suggested back in 1990 that Britain ought to be asked *not* to publish its research results, saying, "*it would be better to minimise BSE by practising disinformation*". In fact, rather than ganging up on Britain, Brussels, via Guy Legras, head of the European Commission's agricultural directorate, warned of the financial repercussions from a beef panic and so hushed up news of the BSE situation.

PAYING THE PRICE OF GLOBALISATION

Cattle may not be the only species within the meat industry that is harbouring the BSE/CJD agent in readiness for the food chain. Until March 1996, no restrictions were placed on feeding cattle offal to pigs and hens.²⁵

Together with a common practice whereby animal-feed manufacturers share the same equipment to mix both cattle-feed and pig-feed, this approach reflects a glaring ignorance within the agricultural industry about the dangerously infectious nature of diseases such as BSE and CJD.

This background, together with the extreme resistance of BSE and CJD to high temperatures and caustic chemicals that customarily rid instruments and tools of infectious materials, may explain the disproportional excess of CJD infection occurring in the farming community. It also brings the focus back to blood-route-transmitted CJD, and raises the prospect of simple kitchen injuries introducing BSE from infected meat products into the bloodstream of an unsuspecting public.²⁶

A worst-case-scenario-sized CJD epidemic will smash rather than stretch every available human resource. European transnationalists, joined in this century by those from the United States, and to a lesser extent Canada and Australia, have widened the gap between developed and developing regions with modern discriminations which transgress the boundaries of human rights, development, environment, nuclear weapons, population, trade and wealth.^{27, 28, 29, 30}

Just as medical impropriety, rather than nature, has already destroyed the lives of 100-plus pituitary hormone recipients and their families, agricultural impropriety in the beef and dairy industry, rather than nature, has snuffed out young lives with an atypical but equally cruel form of CJD spread from cattle.

Humans and animals have paid a huge price for the 60-year reign of institutionalised shortsightedness and its underestimated and mistaken grasp of the CJD/BSE contagion. Notions that whitewash the cull of Britain's cattle population to make early inroads into global greenhouse targets³¹—notions like the current sell-off of British meat at record low prices in Asia, and proposals to restock the sacred herds of India and detonate Cambodia's and Afghanistan's landmines with BSE-infected cattle—are barbarous extensions of a brain-dead culture which serve only to hasten the globalisation of the CJD/BSE epidemic.

With mad-cow maniacs intent on adding manmade BSE to the nuclear waste, toxic chemicals and perilous medications which have already turned Third World countries into dumping grounds for developed-world disasters, surely this is proof that little or nothing has been learned from 60 years of "progress" in economics, science and politics.

Endnotes:

1. Bonn, Dorothy and Ault, Alicia, "Prusiner awarded the Nobel prize for work on prions", *The Lancet* (1997) 350:1079.
2. Webster, Philip and Laurence, Jeremy, "New infection linked to mad cow disease", *The Times*, London, 21 March 1996, p. 1.
3. Dumble, Lynette, "Brain-dead imperialism: Manmade Creutzfeldt-Jakob and mad cow disease", *Third World Resurgence*, no. 75, 1996, pp. 21-24.
4. Eckroade, Robert J.; Zu Rhein, Gabriele M.; Marsh, Richard F.; and Hanson, Robert P., "Transmissible mink encephalopathy: Experimental transmission to the squirrel monkey", *Science* (1970) 169:1088-1090.
5. Gajdusek, D. Carleton, "Unconventional viruses

- and the origin and disappearance of kuru", *Science* (1977) 197:943-960.
6. Manuelidis, Elias E., "Transmission of Creutzfeldt-Jakob disease from man to the guinea pig", *Science* (1975) 190:571-572.
7. Taylor, David M., Dickinson, A.G., Fraser, H., Robertson, P.A., Salacinski, P.R., and Lowry, P.J., "Preparations of human growth hormone free from contamination with unconventional slow viruses", *The Lancet* (1985) ii:260-262.
8. Kumar, Sanjay, "Aetiology of CJD in India is unknown", *The Lancet* (1996) 347:1320.
9. Balter, Michael, "French scientists may face charges over CJD outbreak", *Science* (1993) 261: 543.
10. Macario, Maria E.; Vaisman, Mario; Buescu, Alexandre; Moura Neta, Vivaldo; Araujo, Helena

- M.M.; and Chagas, Carlos, "Pituitary growth hormone and Creutzfeldt-Jakob disease", *British Medical Journal (BMJ)* (1991) 302:1149.
11. Slinger, Sonja, "Scandal grows as deadly disease claims another victim", *The Daily News*, New Zealand, 19 April 1996.
12. Lyons, W.R., Li, Choh Hao and Ahmad, Nazir, "Mammo-trophic effects of human hypophyseal growth hormone preparations in animals and man", in *Growth Hormone* (editors: Pecile, A. and Muller, E.E.), Proceedings of the First International Symposium on Growth Hormone, Milan, Italy, 11-13 September 1967, Excerpta Medica Foundation, International Congress Series No. 158, Amsterdam, 1968, pp. 349-363.

Continued on page 81

DEEP BLACK

The CIA's Secret Drug Wars

The much-publicised "War on Drugs" has been a smokescreen for CIA covert gun-running and drug-trafficking operations aimed at financing "black-budget" projects.

by David G. Guyatt ©1997

All correspondence c/- NEXUS Office
55 Queens Road
East Grinstead, W. Sussex RH19 1BG
United Kingdom

Telephone/Fax: +44 (0)1702 217523
E-mail: david.g7@ukonline.co.uk

A TRILLION-DOLLAR INDUSTRY

The illicit hard drugs industry has a turnover estimated to be well in excess of US\$1 trillion per annum. Put more simply, it is the largest industry in the world. Ongoing international measures to eradicate this industry have largely proved futile, despite the billions spent. For example, the death of Colombian drug baron Pablo Escobar at the hands of law enforcement officers and the capture of Panamanian middleman General Manuel Antonio Noriega by US forces didn't interrupt the flow of Colombian cocaine one iota. On the contrary, shipments to the US and elsewhere increased sharply in the wake of these so-called "drug-enforcement victories".

Meanwhile, information has surfaced that paints a damning picture of intelligence-agency involvement in the drugs industry. Sworn affidavits in my possession finger the US Central Intelligence Agency for engaging in narcotics and cocaine trafficking on an almost industrial scale. Some observers, meanwhile, perhaps with an element of merit, have opined that the CIA's long-term involvement with the drugs industry resulted from their support of nations that strongly adhered to the anti-communist philosophy.

Under this rubric, drug barons the world over were aided and assisted in the production, transportation and distribution of illicit drugs, and the proceeds were used to arm resistance movements. So long as there was a "red menace" to fight, those dope peddlers, large and small, who cooperated with the CIA's Cold War strategy, remained immune to prosecution. With the collapse of communism in the late 1980s, this rationale evaporated. Curious, then, that the narcotics industry has not declined along with communism. On the contrary, all the indications point to continued growth and profits.

Illicit drugs have become a self-perpetuating industry that continues to create billion-aires overnight. It is by far the most *laissez-faire* enterprise of them all, enjoying spectacular financial returns for relatively modest investment—arguably, reason enough to ensure that continuing calls to legalise some types of soft drugs remain doomed to failure at the political level. Why kill the golden goose that effortlessly lays so many golden eggs?

History increasingly suggests that the hidden reality was that it was not so much a "War on Drugs" as a "War for Drugs"—a war, moreover, aimed at winning the hearts and minds of those who live in embattled regions of the globe, while silently impoverishing, stupefying and killing those at home. The innocent, as always, are the major casualties of any war.

CIA COVERT OPERATIONS

What follows is drawn from an affidavit signed by Colonel Edward P. Cutolo; a letter written by his close friend, Paul Neri, an employee of America's huge National Security Agency; and an additional supporting affidavit signed by Private first class William Tyree, a soldier under Cutolo's command.¹ Collectively they amount to a powerful indictment of the Central Intelligence Agency and senior Pentagon officers who knowingly engaged in large-scale narcotics trafficking.

More alarming still are Cutolo's and Tyree's allegations concerning a black operation, suitably named *George Orwell*, that utilised US Special Forces to spy on well-known American politicians, members of the judiciary, law enforcement agencies, and the Catholic Church in New York and Boston. The "product" of this covert surveillance was used for the purpose of blackmail.

Colonel Cutolo was Commanding Officer of the US 10th Special Forces Group (Airborne), 1st Special Forces, stationed at Fort Devens, Massachusetts. Possessing a dis-

tinguished record as a military officer, Cutolo doubtless had seen many peculiar things and undertaken numerous classified missions. Despite this, he would rue the day, in December 1975, that he was approached by the CIA's Edwin Wilson and Frank Terpil.

The two CIA officers introduced Cutolo to two highly sensitive missions unlike anything he had undertaken previously. According to his close friends and comrades, Cutolo's later investigation into the legality of these missions would lead to his death under suspicious circumstances. Other senior military officers who investigated Cutolo's death also soon died under questionable circumstances. All of them are believed to have been murdered by Mike Harari, an alleged Israeli assassin who would come to prominence a decade later for his role in the now-infamous "Contragate" affair.

OPERATION "WATCH TOWER"

Cutolo began his sworn affidavit (dated March 11, 1980) by stating: "In December 1975, I spoke with Colonel 'Bo' Baker concerning a classified mission he commanded during that month, inside Colombia. The mission was known as *Watch Tower*." Continuing, he stated: "Following a lengthy discussion with Col. Baker, I was introduced to Mr

Edwin Wilson and Mr Frank Terpil. Both Wilson and Terpil were in the employ of the Central Intelligence Agency. Both Wilson and Terpil inquired if I was interested in working for short periods of time in Colombia, and I acknowledged that I was."

Cutolo thereafter commanded the second and third *Watch Tower* missions. The second mission took place in February 1975 and lasted a total of 22 days. The purpose of the mission was to "establish a series of three electronic beacon towers beginning outside of Bogotá, Colombia, and running northeast to the border of Panama". With the beacons in place and activated, aircraft could fix on their signal and fly undetected from Bogotá to Panama, landing at Albrook air station.



Old friends? Gen. Manuel Noriega (right) with US Army personnel in Panama City, 1987.

All told, 30 "high-performance aircraft" flew the covert route to Albrook. The aircraft were met by Panama's (then) Colonel Manuel Noriega—who would later become head of state, prior to experiencing a US invasion tasked to arrest and imprison him for laundering drug money. Accompanying Noriega were a number of officers of the Panamanian Defense Forces (PDF), plus CIA agent Edwin Wilson and Israeli agent Mike Harari. Cutolo added that Harari had the authority from the "US Army Southern Command in Panama to be in the AO [Area of Operations]". Nor did Cutolo beat around the bush in explicitly stating: "The cargo flown from Colombia into Panama was cocaine."

Cutolo continued his affidavit by outlining the third *Watch Tower* mission which he commanded. It occurred during March 1976 and lasted 29 days, safely cycling 40 cocaine-carrying aircraft through to Panama. On this occasion, members of one of his Special Action Teams (SATs), located at Turbo, Colombia, were attacked by a large gang of local bandits and were extracted by helicopters that entered Colombian airspace without authority. Cutolo added that the third mission was "met in the previously related fashion by those named—Noriega, Edwin

All of them are believed to have been murdered by Mike Harari, an alleged Israeli assassin who would come to prominence a decade later for his role in the now-infamous "Contragate" affair.

Wilson, Mike Harari, et al."

William Tyree's affidavit (dated September 6, 1990) powerfully corroborates Colonel Cutolo's statements. Tyree, however, was able to provide additional direct testimony on the first *Watch Tower* mission, in which he participated. At that time he was assigned to the 1st/17th Air Cavalry Division located at Fort Bragg, North Carolina. In Tyree's own words, the mission was to "insert three Special Action Teams inside Colombia. Once the SATs were in place they would activate electronic beacons which aircraft could follow through a specific corridor out of Colombia and into Panama where the aircraft, which were loaded with cocaine, would land at Albrook Air Station." Tyree added that the

"mission lasted 24 days, and approximately 37 aircraft of various descriptions flew out of Colombia and into Panama, all following the SATs' electronic beacons."

Tyree went on to state: "I personally witnessed members of the Panamanian Defense Force (PDF) help unload the bales of cocaine from the aircraft onto the tarmac of Albrook Air Station. Among the PDF officers were Colonel Manuel Noriega, Major Roberto Diaz-Herrera, Major Liz del CID, and Major Ramirez.^[2] These men were always in the company of an American civilian identified to me by other personnel involved in the operation as Edwin Wilson, of the CIA. Another civilian in the company of Wilson, I have since learned, was Israeli Mossad Agent Michael Harari."³

Of additional interest are Tyree's comments regarding Edwin Wilson providing (presumably classified) military-style mustard-coloured files to Noriega and his fellow PDF officers. Tyree stated that the files originally belonged to the CIA, Naval

Intelligence Service (NIS) and the Defense Intelligence Agency (DIA). The information contained in the folders appeared to have come from all over the world and included: (a) coastal defences of other countries, some of which appeared to be allies of the US; and (b) written information, diagrams, naval charts and reconnaissance photos, etc. Tyree judged that the information was of a type and quality required to "institute a major naval operation anywhere in the world". Other folders related to the "US Navy and various battle groups, including number of personnel, number of aircraft, type of armaments and whether a vessel had conventional or nuclear capability".

It is impossible to say with any authority why Wilson handed over this type of sensitive information to Noriega. Panama is not famous for its navy—which, in any event, certainly does not possess the capability to project itself around the world. One can only speculate that such information was to be sold or bartered by Noriega to foreign powers, and may have constituted part-payment for assistance with the cocaine trafficking. About this aspect, we are unlikely ever to know.

OPERATION "GEORGE ORWELL"

In any event, after the *Watch Tower* missions Colonel Cutolo returned to normal duty and Tyree was later reassigned to another location and command. There the matter would have rested for evermore had not a curious sequence of events occurred two years later.

By 1978, Colonel Cutolo assumed command of the 10th Special Forces Group (Airborne) at Fort Devens, where he recognised two soldiers: Pfc William Tyree and Sergeant John Newby, both of whom had operated under his command during *Watch Tower*, and who were now assigned (in Tyree's case, reassigned) to his command.

The year 1978 also saw the return of Edwin Wilson with another deep-black covert op on offer: Operation *George Orwell*.

During a meeting with Cutolo, Edwin Wilson explained that "it was considered that Operation *Watch Tower* might be compromised and become known if politicians, judicial figures, police and religious entities were approached or received word that US troops had aided in delivering narcotics from Colombia into Panama." Based on that possibility, Cutolo formed 12 separate SATs. Their mission was to implement US Army Regulation 340-18-5 (File Number 503-05). Cutolo's authority for this action came directly from FORSCOM via Wilson.

In effect, Operation *George Orwell* was tasked with implementing intense "surveillance of politicians, judicial figures, law enforcement agencies at the state level, and of religious groups". The underlying purpose was to provide "the United States government and the Army" with advance warning, should *Watch Tower* be discovered, so they "could prepare a defense". Cutolo further stated that he "was under orders not to inform Colonel Forrest Rittgers, commanding officer of Fort Devens" of this mission. The reason was to give Colonel Rittgers a "margin of plausible deniability" in the event that Fort Devens personnel were "caught in the act of implementing surveillance".

Cutolo went on to reveal that he "instituted surveillance against

Ted Kennedy, John Kerry, Edward King, Michael Dukakis, Levin H. Campbell, Andrew A. Caffrey, Fred Johnson, Kenneth A. Chandler, Thomas P. O'Neill, to name a few of the targets." Additionally, surveillance was placed on "the Governors residences in Massachusetts, Maine, New York, and New Hampshire. The Catholic cathedrals of New York and Boston were placed under electronic surveillance also. In the area of Fort Devens, all local police and politicians were under some form of surveillance at various times." As part of the operation, Cutolo "recruited a number of local state employees who worked within the ranks of local police".

Tyree, in his sworn affidavit, confirmed what Cutolo revealed about Operation *George Orwell*, including that it was initiated under US Army Regulation Number 340-18-5 (File Number 503-05). He stated: "I was involved in ten separate surveillance missions in the New England area, all under this same operation." He added that "surveillance was instituted to monitor civilian targets to determine: (a) if Operation *Watch Tower* had been discovered; and (b) the probability that an investigation or governmental inquiry would be requested as a result of such a discovery." Tyree went on to reveal that he personally participated in surveillance against the Mayor of Lunenburg, Massachusetts, a community close to Fort Devens. A second local target was "John Droney, District Attorney, Middlesex County, Massachusetts". Tyree continued by providing detailed information about criminal wrongdoing by Droney, together with details of his sexual proclivities and indiscretions.

Moreover, Tyree additionally stated that his friend, Sergeant John Newby, had engaged in surveillance against "Senators John Kerry and Ted Kennedy". Sgt Newby also said to Tyree, just prior to his death in October 1978, that he "had been involved in some surveillance of 'some judges' in the New England area". These included "Levin H. Campbell, Andrew A. Caffrey and Fred Johnson". He then went on to reveal that Major Arnett, who was assigned to Fort Bragg, North Carolina (home of the Green Berets), had "commanded a team that allegedly maintained surveillance on Senator Jesse Helms". The connection between Kennedy, Kerry and Helms,

Tyree stated, was that "all three were critical of the US involvement in Latin America". Had they learned of *Watch Tower*, "they would undoubtedly use that information to pull the US out of Latin America, which in turn might affect the security of that area and eventually the US."

Meanwhile, Cutolo stated that Sergeant Newby "had received threats just prior to his parachuting accident that claimed his life in October 1978. It was at that time that (then) SP4 [Specialist, fourth class] Tyree began to report threatening phone calls. I saw a pattern and still believe a pattern exists."

Clearly, by this time Cutolo was fearful for his own life, too: "I gave Colonel Baker the original copy of this affidavit. I gave true copies to Hugh B. Pearce, and to Paul Neri of the National Security Agency, and instructed each person to deliver the affidavit to the authorities in the event that something occurs to me." It did.

Clearly, by this time
Cutolo was fearful for his
own life...

"I gave Colonel Baker the
original copy of this
affidavit. I gave true
copies to Hugh B. Pearce,
and to Paul Neri of the
National Security Agency,
and instructed each person
to deliver the affidavit to
the authorities in the
event that something
occurs to me."

It did.

SUSPICIOUS DEATH TOLL

According to Paul Neri in his accompanying letter, Colonel Cutolo died in 1980 "while on a military exercise in England. Just prior to his death he notified me that he was to meet with Michael Harari, an Israeli Mossad agent. It is my belief, though unsubstantiated, that Harari murdered Col. Cutolo because of the information Col. Cutolo possessed."

Neri then revealed that in the event of Cutolo's death, he was to contact Colonel Bo Baker discreetly. In turn, Colonel Baker enlisted the aid of Colonel Nick Rowe. All three were Special Forces officers with exemplary records. The three of them thereafter set out to "prove that Harari murdered Col. Cutolo".

Colonel Nick Rowe was killed soon afterwards, on 21 April 1989. He was shot to death by automatic fire from an M16 assault rifle in Manila, the Philippines. Neri revealed that "Harari was in the Philippines for three days just prior to and after Col. Rowe's murder".

Chief Warrant Officer Hugh Pearce, who also received a copy of Cutolo's affidavit, died in June 1989 as a result of a helicopter accident. Pearce had commenced helping the others with their enquiries. Prior to his death he had directed Colonel Rowe to an address at Camp Shelby, Mississippi, and state politician Larkin Smith. Both Rowe and Pearce died prior to a scheduled meeting with Smith—both having previously agreed to "go public" and call for a "full investigation into the events described in Col. Cutolo's affidavit" following the arranged meeting. Larkin Smith died in August 1989 in an airplane accident. Others to die conveniently included Colonel Bo Baker and Colonel Robert Bayard—who was murdered in Atlanta, Georgia, in 1977, just prior to his scheduled meeting with Israeli Mossad officer David Kimche.

Clearly, protecting the big secret of Operation *Watch Tower* had assumed priority. This was in fact hinted at in Cutolo's affidavit when he earlier mentioned El Salvadoran Archbishop Romero. Cutolo stated that Romero "is in receipt of physical evidence supporting several allegations that the United States is currently, with Honduras, Costa Rica, El Salvador and Panama, covertly training and sponsoring freedom fighters attempting to overthrow the current regime in Nicaragua." Cutolo then stated that "these freedom fighters are also being supported from funds arising from Operation *Watch Tower* in part." Cutolo closed this paragraph by saying: "This information made it necessary to protect Operation *Watch Tower* and Operation *Orwell* regardless of the cost." Needless to say, he was at that time unaware that he and his closest colleagues would form part of that "cost".

But soon he would grow aware of the threat on his own life: "I have detailed pertinent events in this affidavit should something happen to me. The lug nuts have been loosened on my car tires twice in the past week. I have had someone tamper with my car and I have received telephone calls at my home where no one answered at the other end. I have seen other men involved in Operation *Watch Tower* meet accidental deaths after they were also threatened."

Cutolo simply had too much direct knowledge of Operation *Watch Tower* to survive, especially since he began having doubts about its legality.

GUNS, DRUGS AND NARCODOLLARS

Of an earlier meeting with the CIA's Edwin Wilson, Cutolo stated:

"Edwin Wilson explained that Operation *Watch Tower* had to remain secret, and gave these reasons: (1) If it becomes public knowledge it would undermine present governmental interests as well as those in the future. (2) There are similar operations being implemented elsewhere in the world. Wilson named the 'Golden Triangle' of Southeast Asia and Pakistan. Wilson stated in both areas of the world the CIA and other intelligence agencies are behind the illegal narcotics flow to support forces fighting to overthrow communist governments, or governments that are not friendly towards the United States. Wilson named several recognized officials of Pakistan, Afghanistan, Burma, Korea, Thailand and Cambodia as being aware [of] and consenting to these arrangements, similar to the ones in Panama. (3) Wilson cited the military coup in Argentina in 1976, the coup in Peru in 1978, the fall of the Somoza government in Nicaragua in 1979, and the growing civil war in El Salvador as examples of the need for operations like *Watch Tower*, as these operations funded the ongoing efforts to combat terrorism and defeat actions directed against the United States or matters involving the United States."

In any event, Wilson hadn't yet concluded his drugs lecture to Cutolo, as he went on to explain that "the profit from the sale of narcotics was laundered through a series of banks. Wilson stated that over 70% of the profits were laundered through the banks in Panama.

The remaining percentage was funneled through Swiss banks, with a small remainder being handled by banks within the United States." Cutolo added: "Wilson indicated that a large portion of the profits [is] brought into the banks of Panama without being

checked. I understood that some of the profits in Panamanian banks arrived through Israeli couriers. I became aware of that fact from normal conversations with some of the embassy personnel assigned to the embassy in Panama."

Cutolo then revealed that an associate of Wilson also "aided in overseeing the laundering of funds, which [were] then used to purchase weapons to arm various factions that the CIA saw as friendly towards the United States. The associate's name is Tom Clines." Wilson then told Cutolo that "most of Operation *Watch Tower* was implemented on the authority of Clines." Tom Clines worked under Theodore Shackley, and both of them were heavily implicated in gun-running activities during Iran-Contra—itself a notorious drugs-for-money-for-guns operation under US President Ronald Reagan and Vice-President George Bush.

In fact, Cutolo revealed later in his affidavit that the illegal activities of Mike Harari were protected by a number of US VIPs. Cutolo was told by Pentagon "contacts, off the record" that these

"There are similar operations being implemented elsewhere in the world. Wilson named the 'Golden Triangle' of Southeast Asia and Pakistan.

Wilson stated in both areas of the world the CIA and other intelligence agencies are behind the illegal narcotics flow..."

VIPs included CIA Director Stansfield Turner and former Director George Bush. Both, in Cutolo's words, "shielded" Harari from "public scrutiny". The same contacts also told Cutolo that *Watch Tower* was a sanctioned mission and that "United States military authorities confirmed to me that Operation *Watch Tower* occurred, and gave their approval." Cutolo also learned that "Harari was a known middleman for matters involving the United States in Latin America", adding that the Israeli assassin "acted with the support of a network of Mossad personnel throughout Latin America and worked mainly in the import and export of arms and drugs trafficking."

Motivation in this regard is a contentious issue. Paul Neri stated his belief that Wilson, Clines and Terpil were acting without authority and for their own personal enrichment. Clearly, this was not the case. Cutolo was certain that both operations were sanctioned at the highest level. Of course, this did not hinder some of those involved with these missions from profiting on the side. The indications are that so long as "skimming" were kept at reasonable levels, no questions would be asked by those higher up the chain of command.

BLACK-BUDGET BLACKMAIL

Indeed, Cutolo's affidavit reveals an intriguing sidebar to Operation *George Orwell* that is only too believable in regard to the big bucks world of black budgets.

The surveillance product garnered by Operation *Orwell* had uses other than keeping loose mouths shut. According to Cutolo, he "was notified by Edwin Wilson that the information forwarded to Washington, DC, was disseminated to private corporations who were developing weapons systems for the Dept of Defense. Those private corporations were encouraged to use the sensitive information gathered from surveillance on US senators and representatives as leverage to manipulate those Congressmen into approving whatever costs those weapon systems incurred."

Three weapons systems were mentioned to Cutolo in this respect: "(1) An armored vehicle. (2) An aircraft that is invisible to radar. (3) A weapon system that utilizes kinetic energy." He added that he got the impression all three were for "use by NASA or for CIA purposes".

Wilson also informed Cutolo that "Operation *Orwell* would be implemented nationwide by 4 July 1980."⁴

Cutolo added that, as of the date of his affidavit (March 11, 1980), "8,400 police departments, 1,370 churches and approximately 17,900 citizens have been monitored under Operation *Orwell*. The major churches targeted have been Catholic and Latter-day Saints."

Others targeted included "suspected members of the Trilateral Commission and the Bilderberg group", including former Presidents Gerald Ford, Jimmy Carter and George Bush. Cutolo noted that he did not have personal knowledge "that Ford, Carter or Bush were under surveillance".

Anyone who took an active interest in these operations was soon to experience extreme rigor mortis. In his covering letter, Paul Neri mentioned the death of Supergun builder and "Pentagon scientist" Dr Gerald Bull, who was shot dead outside his apartment in 1990, as an example of the deadliness of Mossad officer Mike Harari.

Neri also cast dark glances at the role of President George Bush

in this whole affair, noting that Bush "knew or should have known about Operation *Watch Tower*". He then added: "With Mr Noriega no longer in power, the Bush Administration has helped install one president and two vice-presidents in Panama who will continue to launder the drug money the CIA receives from drug operations worldwide..."

Neri continued: "How much longer, and how many more will be murdered, die accidentally or be discredited through incarceration so that poppies and coca leaves can fund the secret war of the CIA? Will Latin America be the next secret CIA war, as was the case in Vietnam? And how many of our service people will die there?"

HEROIN HEROICS

Neri's allusion to Vietnam was not without meaning in terms of massive narcotics trafficking by the CIA. Colonel James "Bo" Gritz,⁵ the most decorated Special Forces officer of the Vietnam era, received a copy of Cutolo's affidavit. Some years later he would travel to Burma and meet with warlord Khun Sa, the leading producer of heroin in South-East Asia. What Gritz discovered was fully documented and recorded on video camera.

In a follow-up article Gritz's story will be covered, along with the associated story of US prisoners of war. In this case, the term "Missing in Action" has far more sinister connotations in the view of many who believe that the POWs/MIA's were used as "drug mules" by an unscrupulous CIA, engaged in its

global dope-and-guns business. Many of the names included above, will turn up again.

Cutolo added that, as of the date of his affidavit, "8,400 police departments, 1,370 churches and approximately 17,900 citizens have been monitored under Operation *Orwell*..."

Endnotes

1. Colonel Cutolo's affidavit, dated March 11, 1980 and witnessed by a notary, runs to 15 pages and 86 paragraphs. PFC William Tyree's affidavit, dated September 6, 1990 and witnessed by a notary, runs to 13 pages and 41 paragraphs. Paul Neri's accompanying five-page letter is undated and unsigned and was prepared prior to his death on 29 April 1990 from a long illness. Cutolo's affidavit and Neri's deathbed letter were forwarded by a friend who wishes to remain anonymous. The friend sent an accompanying typewritten letter consisting of one paragraph, neither signed nor dated. All documents are in this writer's possession. Copies of Cutolo's affidavit were given to Colonels A. J. "Bo" Baker, Hugh B. Pearce and James "Bo" Gritz.
2. Cutolo names the same individuals in his affidavit.
3. Extracted from the third edition of *Defrauding America* by Rodney Stich (Diablo Western Press, Inc., PO Box 5, Alamo, CA 94507, USA, 1998, p. 359).
4. My italics.
5. The major film *Rambo: First Blood*, starring Sylvester Stallone, was modelled on Colonel Bo Gritz.

About the Author:

Born in England, David Guyatt is a freelance investigative journalist whose former career in stockbroking and banking gave him the background that inspired his research into the shady world of international weapons financing, drug running and money laundering. His current research interests are focused on military/intelligence mind-control programs and non-lethal weapons systems, as well as the hidden influence of elitist groups around the globe.

POLE SHIFT 2000

The Final Climate Crisis?

Could the uneven build-up of the Antarctic ice-cap trigger a pole shift of the planet?

Part 2

© by Richard W. Noone

Reprinted with permission from
The Philosopher's Stone
(Third Quarter, 1989)

Published by
The Stelle Group

127 Sun Street, Stelle, IL 60919, USA
Telephone: (815) 256 2200

NOTES OF A CONFERENCE WITH EINSTEIN

In January 1955, Charles Hapgood and James Campbell, long an associate of his who worked out the displacement mechanics of the Earth's crust, or lithosphere, met in conference with Einstein. A number of important and fairly technical questions relating to pole shift were discussed in some detail. Those present were Hapgood, Campbell, Einstein, and Mary G. Grand who recorded the event.

After some introductory remarks, Professor Hapgood explained that in the development of the theory he had been concerned mainly with geological and palaeontological evidence, while Mr Campbell contributed basic concepts in mechanics and geophysics. The notes of that conference follow:

"Professor Hapgood explained further that Mr Campbell's calculations had now advanced to a point where he felt that a consultation was necessary. The principal question was whether the tangential portion of the centrifugal effect resulting from the rotation of the ice-cap was the correct order of magnitude to cause fracturing of the Earth's rigid crust. Dr Einstein had stated in a letter to Professor Hapgood that, owing to the oblate shape of the Earth, the crust could not be displaced without fracturing and that the tensile strength of the crust, opposing such fracturing, was the only force he could see that could prevent a displacement of the crust. He had already suggested, therefore, that it would be necessary to compare the bursting stresses proceeding from the south pole ice-cap with the available data on the strengths of the crustal rocks.

"It was this problem that now, through the calculations made by Mr Campbell, seemed to be solved.

"Mr Campbell explained to Dr Einstein the principles he had followed in making the calculations. He used photostatic drawings as illustrations. He showed that the crust, in attempting to pass over the equatorial bulge of the Earth, would be stretched to a slight degree. A bursting stress would arise that would tend to tear the 40-mile-thick crust of the Earth apart. This stress would in all probability exceed the plastic limit of the crustal rocks; that is, they would tend to yield by fracture, if the stress was great enough.

"Dr Einstein said yes, but he wondered how an equilibrium of force would be created. Mr Campbell pointed out that two equal and opposite pressures would arise, since, at the same time on opposite sides of the globe, two opposite sectors or quadrants of the Earth's crust would be attempting to cross the equatorial bulge.

"Dr Einstein agreed that this was reasonable, but raised the question of the behavior of the semiliquid underlayer of the bulge, under pressure from the rigid crust. After some discussion it was agreed that this underlayer, despite its lack of strength, would not be displaced because of the effect of the centrifugal momentum of the Earth.

"Mr Campbell then explained the application of a principle by which the tangential stress proceeding from the ice-cap was greatly magnified. He considered that the bulge of the Earth, starting with zero thickness at the poles and approaching 6.67 miles in thickness at the equator, behaved physically as a wedge resisting the movement of the crust. Since the distance from pole to equator is about 6,000 miles, the ratio of this wedge was 1,000:1; but the existence of two wedges on opposite sides of the globe reduced the ratio to 500:1.

"The ice-cap's tangential effect, multiplied by 500 and divided by the number of square inches of the cross-section of the lithospheric shell at the equator (assuming the crust to be 40 miles thick), produced a bursting stress on that shell of 1,738 pounds per square inch.

After examining each step in the argument twice, Dr Einstein had the impression that the principles were right, and that the effects were of the right order of magnitude. He stated that he would be satisfied if the bursting stress and the strength of the Earth's crust were in the ratio of not more than 1:100, since the Earth's crust varied so greatly in strength from place to place and would undoubtedly yield at its weakest point.

"Mr Campbell explained an effect he had often observed, which illustrated the process by which the crust of the Earth might yield to fracture. A common method of splitting a block of granite is to drill two small holes, about six inches apart, near the center of the long axis of granite, and insert and drive home a wedge in each hole. A bursting stress of sufficient magnitude is brought to bear to split the rock. However, the rock is not split all at once. Enough stress is brought to bear to start a fracture, but the fracture does not take place instantaneously. If the wedges are put in place in the evening, it will be found next morning that the whole rock has been split evenly along a line extending through the two holes. The fracture has slowly migrated through the rock during the night. The force required to split rock in this way is but a fraction of that required to split it all at once. So far as the Earth's crust is concerned, what is required is not a force sufficient to split it all at once, but simply a force sufficient to initiate a fracture or fractures which will then gradually extend themselves during possibly considerable periods of time.

"Professor Hapgood next described the geological evidence of worldwide fracture systems extending through the crust and weakening it, and the remarkable similarity of those patterns to those which, theoretically, would result from a movement of the crust. Dr Einstein expressed great interest in this evidence.

"Professor Hapgood referred to the Hough-Urry findings of the dates of climatic change in Antarctica during the Pleistocene.

Dr Einstein stated that the method of radioactive dating developed by W. D. Urry was sound and reliable. As a result, Dr Einstein was in full agreement that the data from Antarctica, indicating that that continent enjoyed a temperate climate at a time when a continental ice-cap lay over much of North America, virtually compel the conclusion that a shift of the Earth's entire crust must have taken place."

IS THE POLE MOVING NOW?

Might there be another pole shift in the future?

It seems reasonable to suppose that, given the ice-cap's continual growth, the Earth's crust will once again, at some point in the future, respond to the increasing bursting stress by catastrophic fracturing.

When Professor Hapgood and Dr Einstein were at work on their calculations in the 1950s, they had no way of anticipating several recent discoveries that are pertinent to their research. Had they known of these recent events—and their impact on the growth of the off-centre Antarctic ice sheet—they might have placed more urgency on their work.

OUR CHILLING WORLD

In 1977 the US Central Intelligence Agency reported that climatic changes begun in 1960 had gone unnoticed until the early 1970s.¹ It says the world's climate is cooling and will revert to conditions that prevailed between 1600 to 1850. "The change of climate is cooling some significant agricultural areas and causing drought in others," as we see today in Africa.

The report, as chilling as the ice growing at the south pole, says this catastrophic climate change means we can expect the death of 150 million persons in India from starvation, unless world reserves can furnish 30 to 50 million metric tons of grain there *yearly*. With a one-degree-Centigrade drop in temperature, China, with a major famine every five years, would require a supply of at least 50 million metric tons. Canada, a major grain exporter, would lose over 50 per cent of its production capability and 75 per cent of its exports in this commodity. Northern Europe would lose 25 to 30 per cent of its present production capability, the [former] Soviet Union would lose Kazakhstan for grain production, thereby showing a yearly loss of 48 million metric tons, while exports of the Common Market [European Union] countries would fall to zero. As part of the world community, the United States would be much affected by these developments. As the CIA reported, "The economic and political impact of major climatic shifts is almost beyond comprehension."

Moving into a colder environment means that the accumulation of ice at the south pole could be

increasing far more rapidly than Hapgood and Einstein would have thought possible. Nor could they know of the extraordinary 766-page "Global 2000 Report to the President", published in 1980.² Richard Strout, Washington correspondent for the *Christian Science Monitor*, wrote, "I defy anyone to read the summary of the report without a shudder." The report warns that time is running out.

ICE-CAP INSTABILITY

Other factors possibly contributing to even faster polar ice build-up include the alarming accumulation of CO₂ in the atmosphere, which supplies the moisture for extremely rapid glaciation;³ the worldwide death of micro-organisms in the Earth's soil,⁴ and its likely result, the worldwide death of trees;⁵ a worldwide



Displacement of the Lithosphere

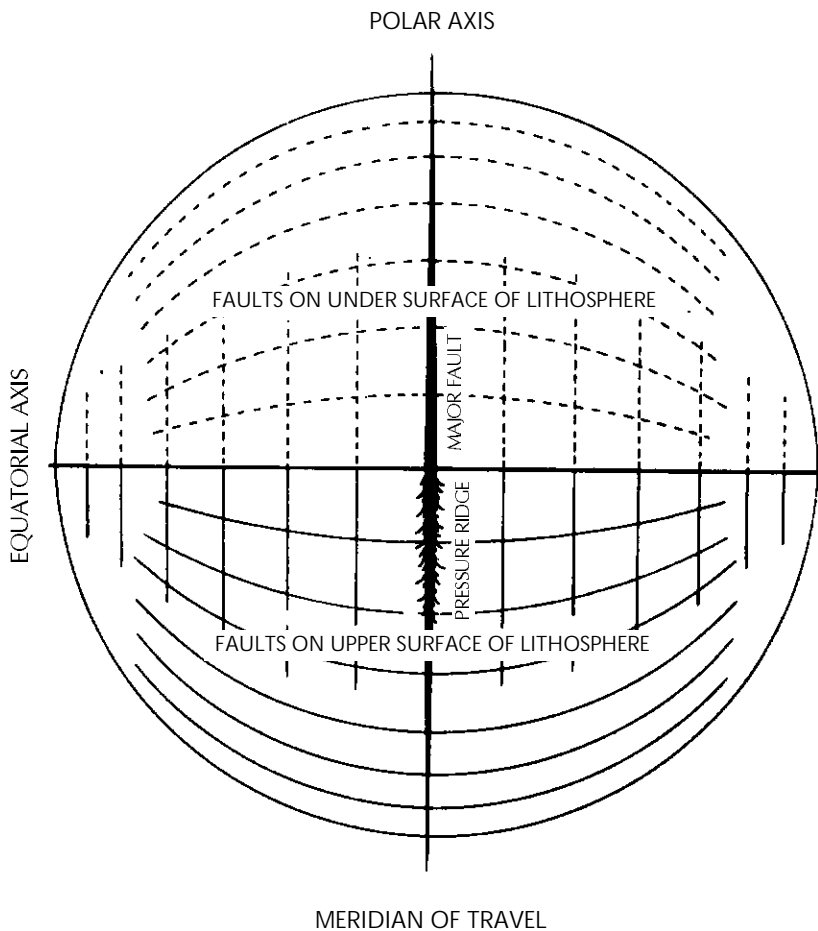

Patterns of Fracture

This figure indicates schematically the mechanics of faulting and folding in a displacement of the lithosphere. It is suggested, for purposes of illustration only, that all effects are concentrated on the meridian of maximum lithosphere displacement. Therefore, only one major meridional fault is shown in the upper hemisphere, which is moving toward the equator. Dashed lines indicate other faults opening from the bottom of the lithosphere as the arc of the surface diminishes. Across the equator, where the surface is moving toward the pole and compression is resulting, the continuation of the major expansion fault is shown as a pressure ridge, which may later become the main axis of a mountain range. Again, for purposes of illustration only, it is assumed that all folding will take place along the meridian of maximum displacement. If the major fault is filled with molten magma, and the magma solidifies, then this intruded matter, which has expanded the lithosphere, must add to the folding in the lower hemisphere, which is moving toward a pole. In the lower hemisphere the unbroken lines indicate fractures opening from the top, as the arc of the surface increases. (From *Path of the Pole* by Charles H. Hapgood ©1970. Reprinted by permission of the author.)

Vertical View

This figure illustrates a number of simultaneous effects of displacement. The upper right-hand quadrant shows a sector of the lithosphere displaced toward the equator. Here the lessening arc of the surface will cause faults to open from the bottom. The lower right-hand quadrant shows a sector of the lithosphere displaced toward a pole. Here the increasing arc of the surface results in faults opening from the top. The lower left-hand quadrant, which is a vertical view of a sector moving equatorward, shows major meridional faults which have opened from the bottom. The upper left-hand quadrant, which is a vertical view of a sector displaced poleward, shows meridional faults opening from the top. The reader should visualise the left-hand quadrants as if looking straight down in the Earth at the point where the central meridian of displacement (96°E longitude, in this case) crosses the equator. (From *Path of the Pole* by Charles H. Hapgood ©1970. Reprinted by permission of the author.)

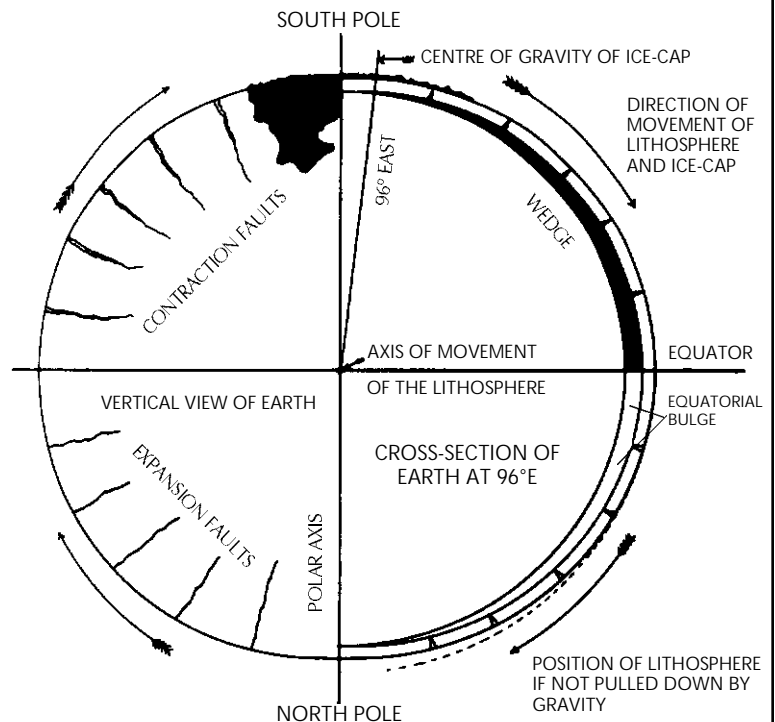

increase in deserts which reflect into space 30 per cent of the solar energy they receive, further chilling the Earth;⁶ an alarming increase in forest fires worldwide,⁷ which, among combustion products, put more CO₂ into the atmosphere, supplying the moisture to build more and more ice—which reflects 80 to 90 per cent of solar energy into space.

In 1966, 444 billion tons of ice were added to the interior of the south pole's ice mass.⁸ Should this rate of growth simply have remained constant in the last 14 years, it would mean that, by 1980, six trillion tons were added to the already off-center ice-cap deposit.⁹

In 1970 the ice-cap's centre of gravity was 345 miles from the polar axis.¹⁰ The huge weight of the ice-cap has depressed the ground below sea level in many places so that much of it is lying on slippery bedrock.¹¹ Meltwater penetrating the cracks and crevices of the ice sheet may also serve as a lubricant.¹² The underlayer, or asthenosphere, below the Earth's crust would also act as a lubricant because its rocks are too hot to crystallise.¹³

Campbell compared this asthenospheric movement to the motion of ice floes:

"Observe how vast fields of ice are started in motion just by the friction of the wind on the surface of the ice... Again, you will see the same thing by visiting a pond where they are cutting ice. You will see men pushing around blocks of ice of three or four hundred square feet with the greatest ease as long as the ice is floating on the water..."

Because of the above developments, I believe we might safely infer that the south pole's ice mass may not be one of the most stable geological constructions on Earth. But has it already begun moving?

THE MOVING CRUST?

Two rather curious pieces of evidence suggest that the Earth's crust may be in motion. We have two observations of a shift of the north pole with reference to the Earth's surface.

The first observation is cited by Deutsch¹⁴ on the authority of Munk and MacDonald. It suggests that the north pole moved 10 feet in the direction of Greenland, along the meridian of 45° West longitude, during the period from 1900 to 1960. According to Deutsch, this would indicate a rate of six centimetres (about 2.5 inches) per year.

The other finding, cited by Markowitz¹⁵ and based on older data, suggests the pole shifted about 20 feet between 1900 and 1968, along the meridian of 65° West longitude, and that it is now moving at a rate of about 10 centimetres (four inches) yearly.

The difference between the two longitudes may not be particularly significant, as the angular difference so near the pole is small, but the difference in the two rates of motion may be very important.

First, it must be noted that a speed of 10 centimetres yearly is two or three times the maximum speed usually estimated for sub-crustal convection currents. This appears to imply that the displacement indicated as now occurring is not powered by convection currents. Another mechanism may be at work.

The second point, possibly even more interesting than the first, is that if both these observations were accurate—as we have every right to expect in view of the eminence of the investigators—then here we may have evidence of a geometrical acceleration of the rate of motion. If the pole shifted 10 feet between 1900 and 1960, but 20 feet between 1900 and 1968, then it moved 10 feet in only eight years, suggesting acceleration by a factor of about eight.

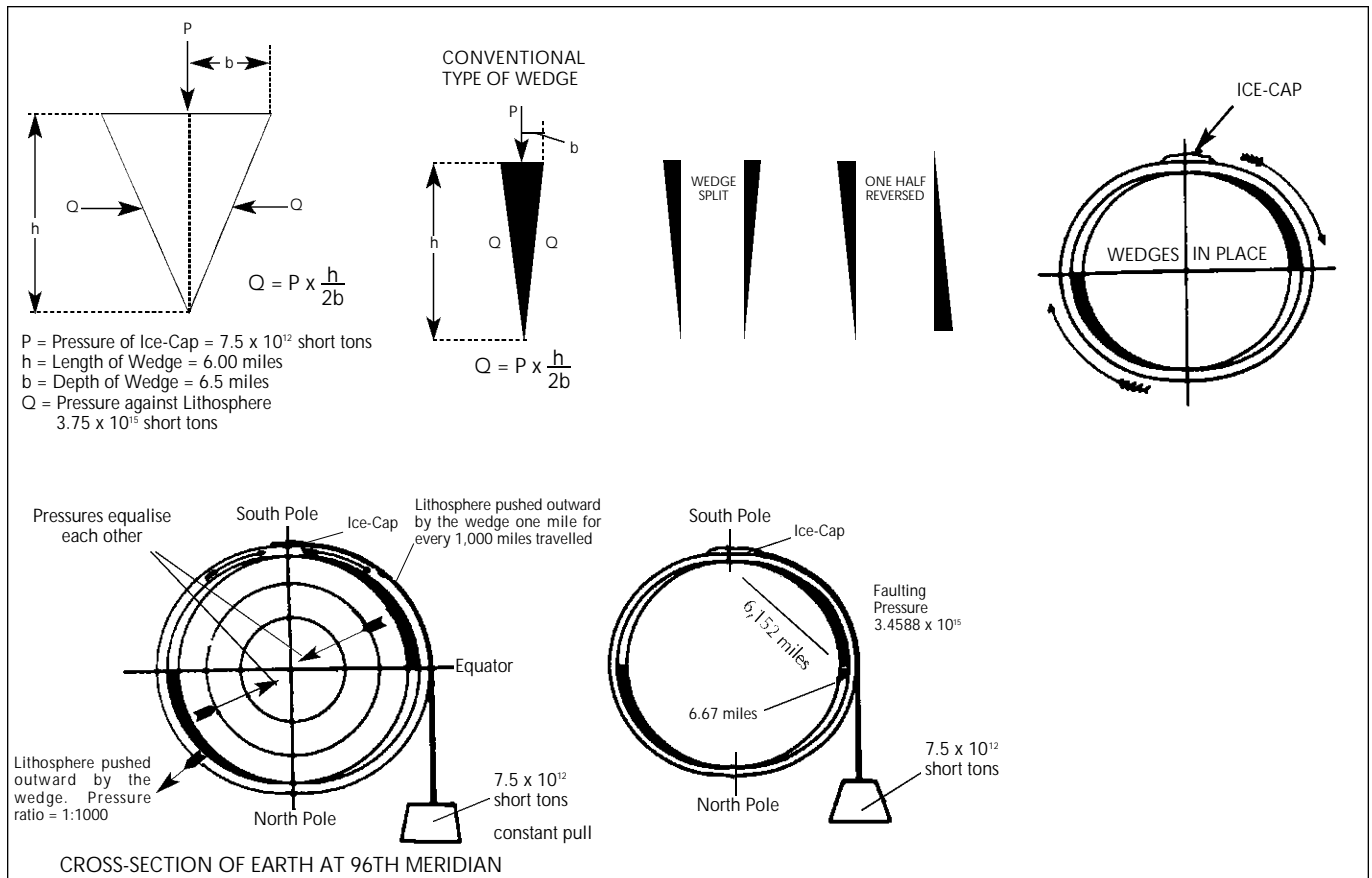

The mechanical principles of the wedge, from *Path of the Pole*, ©1970 by Charles H. Hapgood. Reprinted by permission of the author.

The mechanism is based on a formula involving the geometrical progression of centrifugal effects; that is, the formula for calculating centrifugal force, which is a simple methodology (see Technical Appendix).

THE ICE-CAP IN MOTION

Two distinctly separate physical functions are discernible in the ice-cap. The first is the centrifugal momentum causing the crust to change its position in relation to the poles. When the crust comes to a standstill for want of sufficient force, the second function, that of the wedge, commences to build pressure of tremendous potential—500 times the force produced by the ice-cap—that would continue to build at the rate of 500 times the increasing pressure until it finally split the crust.

Then the pressure drops and the first function would take hold and once again begin moving the crust. This alternating action would continue until the ice-cap is destroyed by the equatorial sun.

The wedge does not multiply the power of the centrifugal momentum as such. The power disposed for the crust's movement remains the same, but the static pressure that would fracture the crust and thereby permit the ice-cap's centrifugal momentum to start crustal movement would be multiplied by 500.

The wedge has likely been functioning ever since the first permanent snow fell on the Antarctic continent; it is, for the moment, probably still functioning today. At the same time, the centrifugal momentum of the ice-cap may be patiently standing by, waiting for the crust to fracture.

Is it awaiting that moment when the crust fractures to release an ice-cap larger than the United States and Mexico combined¹⁶ for a holocaust-like journey toward the equator?

Only time will tell.

Endnotes

1. Noone, Richard W., *5/5/2000: Ice, The Ultimate Disaster*, Crown Publishing, New York, 1982, 1986 (revised 1997), pp. 313-14.
2. *ibid.*, p. 307.
3. Hamaker, John D., *The Survival of Civilization*, Hamaker-Weaver, Burlingame, 1982, pp. 69-74.
4. *op. cit.*, p. 25.
5. *op. cit.*, p. 125.
6. *op. cit.*, p. 165.
7. *op. cit.*, p. 88.
8. Bull, Colin, *Snow Accumulation in Antarctica*, Institute of Polar Studies, Columbus, Ohio, USA, 1971.
9. Noone, *op. cit.*, p. 326.
10. Hapgood, Charles H., *Path of the Pole*, Chilton, New York, 1970, p. 338.
11. *ibid.*
12. *op. cit.*, p. 27; data according to J. Tuzo Wilson.
13. Runcorn, S.K. (Ed.), *Continental Drift*, Academy Press, New York, 1962, p. 143; according to Campbell.
14. Deutsch, Ernst R., "Polar Wandering and Continental Drift", in Munyan, Arthur C. (Ed.), *Polar Wandering and Continental Drift*, Society of Mineralogists, Tulsa, Special Publication No. 10, July 1963.
15. Markowitz, William and Guinot, B., *Continental Drift, Secular Motion of the Pole and Rotation of the Earth*, International Astronomical Union Symposium No. 2, Dordrecht, Holland; Reidel, 1968; Springer, New York, 1968.
16. *World Book Science Annual*, 1975, p. 96. See also *World Book Encyclopedia*, vol. A, p. 323, 1955 edition, which stated that the Antarctic continent was only "two-thirds as large as North America".

Editor's Note:

Due to space constraints we are postponing our promised summary of climate change reports until the next issue of NEXUS—by which time there will be even more conflicting news to report!

About the Author:

Richard W. Noone is the author of *5/5/2000: Ice, The Ultimate Disaster*, first published in 1982, and republished in 1986 by Harmony Books, a division of Crown Publishers, New York (revised Three Rivers Press/Crown edition, 1997).

TECHNICAL APPENDIX

The calculations of the centrifugal effect of the present Antarctic ice-cap and the resulting bursting stress on the crust were worked out by Campbell. The phraseology here is in part that of Dr John M. Frankland, of the US Federal Bureau of Standards, who was kind enough to review the calculations.

a. Centrifugal Effect of the Rotation of the Antarctic Ice-cap:

Assume isostatic adjustment 0, centre of gravity of the ice-cap 345 miles from the polar axis, and volume of the ice equal to 6,000,000 cubic miles.

W = Weight of the ice-cap = 2.500×10^{16} short tons,

F = Centrifugal effect in pounds = Wv^2/gR , where

v = Velocity of revolving ice-cap, 132 feet per second,

R = Distance from the axis of rotation to the centre of gravity of the ice-cap = 345 miles = 1,821,600 feet,

g = Acceleration due to gravity = 32.

$F = Wv^2/gR = 2.5 \times 10^{16} \times 132.45^2/32 \times 1,821,600$
 $= 43,870.75 \times 10^{16}/58,291,200 = 7.5 \times 10^{12}$ short tons
 $= 6.8 \times 10^{12}$ metric tons, radial force tangential to the Earth's surface. (This, of course, is an upper estimate and may be too large by a factor of two or three.)

b. Bursting Stress on the Lithosphere:

An approximation of the bursting stress caused by this centrifugal effect can be reached by simple methods, as follows. More elaborate approaches hardly seem justified in view of the uncertainty of the magnitude of the centrifugal force.

It is assumed that the entire resistance to the motion of the lithosphere arises from the fact that the Earth is not a perfect sphere but an oblate spheroid. The tangential, or shearing, stresses between the lithosphere and the underlying asthenosphere are considered negligible because of the time factor and because of the assumed viscosity of the asthenosphere.

If one considers the great circle passing through the centre of gravity of the ice-cap, at right angles to the meridian of centrifugal thrust of the ice-cap, it is evident that the circumference of this great circle will be increased if the ice-cap is displaced away from the pole. Of course, any stress system that arises in this way will be two-dimensional, but one will hardly be in error by a factor of more than two if one neglects the two-dimensional character of the stresses and assumes instead that they are uniaxial. Of course, the only purpose of this computation is to show the effect's order of magnitude.

With this kind of approximation, one may view the equatorial bulge as a kind of wedge upon which the lithosphere is being pushed. There are, of course, two wedges, one on each side of the globe.

The bursting stress is the product of the tangential effect of the ice-cap by the ratio of the gradient of the bulge:

1) Thickness of bulge (wedge) at its butt end = 6.67 miles.

2) Ratio of travel to lift, of bulge wedge = 6,152:6.67.

3) Stress on cross-section of the lithosphere (taken as 40 miles thick) = $7.5 \times 10^{12} \times 6,152/6.67 \times 2 = 3.3488 \times 10^{15}$ short tons = $3.4588 \times 10^{15}/990,894 = 3.5 \times 10^7$ short tons per square inch = approx. 1,700 pounds per square inch.

INDUCED REMISSION THERAPY

Our Best Hope Against Cancer?

Dr Sam Chachoua has developed a safe, effective vaccine for healing cancer, AIDS and other terminal illnesses, but medical authorities continue to ignore his work and try to prevent his treatments from becoming widely known.

Part 1

by Sam Chachoua, MB, BS

©1997

Extracted from his forthcoming book, *The Challenge, The Promise & The Cure*, to be published in 1998.

Telephone: +1 213 655 0271

www.peg.apc.org/~nexus/chachoua.html

TRUTH, LIES AND CONSPIRACIES

Cancer, AIDS, heart disease: three faces of death that devastate so many lives. Many believe that modern medicine will someday develop effective therapies. Those afflicted, their friends, family, lovers, pray that the breakthroughs will come one day soon.

Imagine that the world was offered new treatments and even cures. Newspapers, television, radio and magazines would carry images of medical triumph supported not only by hard data but by living, walking, healthy miracles. Imagine the impact this gift would have on millions of lives: the fulfillment of dreams, the awakening of hope. Try to imagine that the announcement was made, but the world slept through it. Try to picture a public reception with indifference and a medical society charged not to embrace but to destroy all embers of this success.

If the scenario is hard to picture, then don't try to imagine it but try to remember. It happened. I know. I developed the technology. I made the announcement.

I had always known that the medical system would take some time to change, to develop, but I could not have believed that the public announcement would fall on the deaf ears of victims, nor that my peers would challenge me not on the science of my achievements but with baseless rumours, lies and personal attacks. I could never have anticipated that in answering the dreams of so many, my life would turn into a nightmare.

A THREAT TO THE STATUS QUO

The summer of 1995 was the proudest in my life. Fifteen years of research and medical trials had been building up to this one moment: the triumphant return to my adopted homeland Australia, and the fulfillment of a promise I had made to myself as I watched my father die of cancer so many years before.

Investigating three previously overlooked phenomena—organ resistance, organism resistance and spontaneous remission—I had developed effective vaccines for the prevention and treatment of many killer diseases. The genesis of what I call "Induced Remission Therapy" had begun in Australia more than a decade earlier, but I had spent five years touring the world, lecturing and training doctors in hospitals and institutes. I was returning with independent proof: dramatic and overwhelming evidence that a new age of health was being ushered in. I was returning home to present my discoveries and to fund all research and development in this field.

Armed with X-rays, blood tests, preliminary data from the Colorado University Medical School, UCLA, Cedars Sinai Medical Center and undoubtedly the strongest proof: patients in remission from cancer, AIDS and heart disease—rescued after all other options had been exhausted. This should have been the realisation of my life's goals. Via the media, millions would meet the success stories and hear of my offer of A\$100,000 to initiate investigations in Australia of this new therapy. Then, suddenly, silence. All research institutes were eligible for the \$100,000 grant but none came.

I found myself suddenly in the vacuum of a media blackout. Interviews were cancelled, news stories were not run. The public returned to its comfortable staple of cancer "breakthroughs" that may come to be in the next 10 years, the almost weekly announcements from the familiar research institutes. Soon, to the public, I became a forgotten memory. To other interests, however, I was a threat that needed to be destroyed.

A direct frontal assault on Australian soil was not the way, though. I am a medical doctor in Australia; that gives me certain powers and rights. I had offered money to have my

therapies proved or disproved, and I had reached out to the public. Attacking me overtly would have raised too many questions. Backed by data from some of the world's most prestigious research institutes, I was offering my technology with no strings attached.

Australian Medical Board representatives attempted to chastise me for what they believed were obvious lies and deception. They demanded to know who had evaluated my data and where. They accused me of falsely raising hope in poor, dying individuals. It seemed okay to announce that you can cure an occasional rat and raise millions in public donations if you are an institute; however, to say that you can help people and not ask for, but *offer* money to prove your point was not quite the done thing. Interestingly, the Medical Board enquiry into my "unprofessional" behaviour was the first time I had divulged details of the contacts and institutes investigating my technology. Incredibly, within days, these centres would not only cancel their collaboration with me but also, paradoxically, begin to deny that one had ever existed.

In the USA and Mexico clinics opened up, offering my therapy but delivering heaven-knows-what to unsuspecting patients. I initiated legal action to shut them down, but then became a victim of intense personal and professional attacks as well as physical attempts on my life. I was disgusted to learn that members of UCLA and Cedars Sinai took part in my denigration, but I was in for an even greater shock. When the names of individuals from the Australian Medical Board were used against me, I asked them to intervene; they would not. It seemed that my own Medical Board was supporting the attacks, even if only by inaction.

What is even more incredible is that amongst all the lies were claims that my MB, BS (the Australian medical degree) was not that of a doctor but rather of a nurse or undergraduate. In court, American expert witnesses testified to that and the Australian Medical Board seemed to go along for the ride.

Despite incredible resistance and bias, I won the court battle—but the war to save lives still rages.

Unlike stories of conspiracies and cover-ups from long ago, this is happening *now*. I am still alive; the dream need not be lost, then mourned. The proof is there if you would only look.

I would never have imagined that the hardest part of healing cancer and AIDS would be to get people to listen.

This is my story and our dream. Please read; read and remember.

ACCELERATED DREAMS

Every child has dreams and aspirations, major contributions to make, marks to be left, fame to be found—and what feels like an eternity in which to accomplish these objectives. Curing cancer, growing up to be a hero, saving mankind—these must be some of the commonest fantasies of the young. Impossible tasks seem achievable because there is so much time—time to study, time to grow, time to prepare. Time allows for attainable fantasies, for pleasant dreams. When time is shortened by age or situation, when there is a need for rapid realisation of the dream, reality destroys fantasies and dreams are either abandoned or are often transformed into tangible despair that mourns its loss by cutting harsher than reality ever could.

My father was first diagnosed with cancer in 1975. He was

aware of the multiple myeloma (a cancer of the bone marrow) several months prior to submitting to investigations and therapy. Multiple myeloma at the time was treated only when symptomatic, as therapy was felt to decrease lifespan, so he felt no rush to confirm his diagnosis.

He also felt no rush in informing me of his condition. My brother and sister had already entered medical school; I had entered puberty. My father worried that the news would devastate me and affect my studies. Even when faced with death, his concerns were for my life and future. So much changed in the next few years. My father, the workaholic, became much more the family man; always my hero, now my best friend.

STEPPING STONES, ALTERED PERCEPTIONS

Cancer is a disease that has repeatedly thwarted a cure. To defeat it, surely one did not simply need to understand current teachings, one needed to excel. Curing cancer was not within current knowledge, therefore one needed not only to master existing technology but to surpass it.

When seen as stepping stones to achieving my dream, teachings were devoured. I top-marked in several exams and received the T. F. Ryan Roentgen Prize in physics. I tried to apply every new nugget of information to my father's situation. Biochemistry taught of new agents that could increase the efficacy of chemotherapy and radiotherapy, and of cellular toxic agents that were presented in other contexts. Review of old and new medical research often showed that these agents had been used, and failed to demonstrate efficacy. Chemical therapy of cancer was receiving such intense worldwide scrutiny that it was virtually impossible to generate an original thought or concept from within the field.

Perhaps the answer then lay in the application of unrelated technology to the cancer problem. In physics we were taught that ultrasonic waves would have different heating coefficients depending on the density of the target; that is, the harder something was, the hotter it would become when exposed to ultrasonic frequencies. Cancer was usually denser than normal tissue, and my father's cancer, being surrounded by bone, could be heated up much more so than surrounding soft tissue. Perhaps such preferential heat damage could kill the cancer.

I approached several cancer researchers. They seemed as excited as I was but cautioned me to check past publications on the subject. Thirty years previously, someone had applied that effect to cancer with marginal and occasionally harmful responses.

If preferential attacks on cancer were not the answer, perhaps protection of normal structures against toxic agents would allow for more savage attacks against cancer. I discovered entire fields of science on the topic of radioprotective and chemoprotective agents. It was almost impossible to generate an original thought within the confines of chemotherapy and radiotherapy, yet despite continued failure these modalities seemed so powerful, so alluring. Cancer was killing my father; I wanted to hit back, hard!

Searching for metabolic weaknesses; poisoning some pathway essential to cancer but not to normal cells; combining modalities of chemotherapy with each other, with radiation, with hormones—everything had previously been done and had failed.

I would never have imagined that the hardest part of healing cancer and AIDS would be to get people to listen.

Cancer was seen as a disease of excess (too much smoking, radiation, pollution etc.); the generation of an evil, foreign life-form which battles and invariably destroys its host. Excess must be cut down, taken away, burned or poisoned. This logic, combined with the frustration and hatred generated by this invulnerable nemesis, had locked us into the mindset that dominates current therapies—therapies that have failed us for so long, yet which we refuse to abandon.

STANDARD CONCEPTS OF CANCER

I would like to outline the concepts that have dominated cancer research and therapies over the past few decades. Understanding failure is a useful tool in attaining success.

By definition, cancer is a rogue cell which multiplies without respect for normal systems of cellular control and develops into a mass that invades and destroys normal tissue and structures. It is a powerful, mindless beast that spreads, grows more rapidly than normal tissue and ultimately leads to the death of the host.

Cancer growth rate may be slowed or accelerated by a variety of infections. Even in its natural history, cancer growth is not constant, for during the life of the patient the disease often grows in spurts. It is not uncommon for some cancer metastases to shrink, while most increase in size.

Cancer, the "mindless beast", starts in a localised area, invades circulatory and lymphatic systems, then spreads throughout the body. Certain cancers exhibit specific patterns of spread, long held by conventional teachings to be dictated by the pattern of circulatory distribution of micro-tumour emboli. This belief furthers the concept that cancer is a rampaging monster, cast by chance to spread its deadly seeds. Passively carried by blood and lymph to their new targets, cancer cells are undifferentiated, non-specific parcels of destruction that care not where they lodge and are not part of the decision-making process in their travels to new organs.

SEARCHING FOR MISSING DEFENCES

A few observations regarding cancer in its population and age distribution are cited repeatedly in immunotherapy literature. Essentially, increased cancer incidence occurs with immunodeficiency; and age, particularly past puberty, also appears to be a promoting factor.

If one considers only these observations, one can conclude that after puberty there is a loss of some vital immune-protective agent. If only we could identify it and replenish it, perhaps we could then triumph over this living nightmare.

The most likely candidate for our source of white blood cells in shining armour seemed to be the thymus gland, a master immune-cell generator which atrophies by early teenage years. Its degeneration seemed to correlate with increased appearance of cancer.

Therapies have proliferated over the years where part or all of the thymus, its products and hormones were used to treat cancer patients. Results were marginal to non-existent, yet, of all the borderline alternative therapies, thymus supplementation persists most stubbornly. Propelled by a romantic notion, hope does not fade—even when it is a false hope.

This restricted logic may have been sound. Perhaps we had fixated on the wrong atrophied organ.

ORGAN RESISTANCE

A common observation, even in the most advanced of malignancies, is that some organs and tissues appear resistant to cancer spread and invasion. The small intestine not only resists spread but also very rarely develops primary cancer. Perhaps there is specific immunologic capacity in the small intestine that prevents cancer from developing and protects it from tumour spread.

A quick search of anatomy and immunology books revealed that the small intestine is blessed with its own immune protection in the form of lymphoid aggregates called "Peyer's patches". Much of the function of this line of defence is restricted to the small intestine and does not circulate. This could account for the cancer resistance being local.

Studies of lower animals, particularly birds, indicated that their main immune-processing organ was not the thymus but was located in their embryonic and foetal intestine. Could this part of human immunology have been delegated an unfairly low status? In the animals, their capacity to transfer immune resistance to the entire body is optimal early in life. What if human correlation exists whereby there is transfer of resistant factors between Peyer's patches (and immune responses localised to the small intestine in later life) and the rest of the body early in life?

In view of the logic supporting thymic supplementation and the hope that restoration of an atrophied organ would destroy disease, there was another interesting observation with relation to Peyer's patches. Intestinal lymphoid aggregates atrophied with age. We had been so obsessed with the thymus that perhaps we had overlooked the real saviour.

THOUGHT TO ACTION

I had yet to start medical school but spent a good deal of time at the Peter McCallum Cancer Institute in

Melbourne where my father was receiving treatment. He had introduced me to several oncologists and I approached them with my ideas. The general response was condescending but usually polite. Dr Ian Cooper, chief haematologist, was not only supportive but also advised me to formulate my ideas as an experimental protocol and present it to Dr Jose of the Immunology Department.

The reply to my preliminary correspondence was surprisingly encouraging: I was invited to address the weekly group meeting of the immunology research team. I prepared theory, protocol and an experimental design.

The presentation was informal and pleasant. Researchers from around the world had submitted protocols for review by this unit. Immunostimulants, interferon, interleukin, lymphocyte harvest pre-chemotherapy: the suggestions were complicated but the themes familiar. I had heard or read about all these concepts before; worse yet, the experiments had been done and repeated years previously. I felt encouraged; my protocol was the only original idea being presented on that day. Surely a new concept would be more appealing to a research unit on the cutting edge of technology than simple repetition of prior failures?

To demonstrate that Peyer's patches could be stimulated to produce anti-cancer activity, I proposed that lymphocytes isolated from these aggregates be tested against those taken from the spleen and other sources for efficacy against cancer. For obvious reasons I chose multiple myeloma as the cancer system to attack. An important design feature was the testing of ordinary extracts to

A quick search of anatomy and immunology books revealed that the small intestine is blessed with its own immune protection in the form of lymphoid aggregates called "Peyer's patches".

check for inherent activity and the evaluation of lymphocytes exposed to the cancer during the animal's life to search for induced activity.

I was aware that the members of the unit had not been previously exposed to this approach; it was new to them. I was also aware that they were not in the least interested.

The first question I was asked was by Dr Jose, requesting the sources and literature supporting this concept as well as data on previous trials and their conclusions on this issue.

"This experiment hasn't been done before!" I claimed proudly.

"But we need to see prior work in this field," he countered. "That is a key factor in our accepting experimental protocols!"

In that instant, I understood an intrinsic flaw in the cancer research industry. In order to realise easy acceptance of ideas and receive grants, it was important to show that you were travelling down the same well-worn path of prior investigations.

"I don't understand," I replied. "Are you telling me that you won't do this because it hasn't been done before?"

"It is hard for me to allocate funds to work lacking prior experimental and data references." (In essence, he meant "yes".)

"We have no cure for cancer; we aren't even close. How will we find it if we don't explore new avenues?" I did not mean to sound cocky, but all of my hope and courage were suddenly dissipating. I was being rejected.

"We are on a strict budget and have defined guidelines."

I would not be dismissed; my chance to save my father demanded their acceptance.

"Okay, I'll pay for it!" (The first of many times that this phrase would pass my lips, and about the only time that I would not regret it.)

Dr Jose smiled and relented. "We'll see," he said. "Go do an intensive literature search; we'll start arranging things next week. Your ideas are interesting and worth exploring."

My father, Isaac, was by now confined to a wheelchair and my mother, Catherine, catered to his every need and whim. He had been a whirlwind, an active workaholic who delighted in helping the ill. Now confined to a chair and to bed, he exhibited a spirit and attitude that I have since come to realise is far from common. Isaac wasted no time cursing his debility but would focus on how long he was able to stay in his garden, tending to his plants, or on how active and pain-free he could be on a particular day.

That day, my father and mother awaited my return from the conference with anticipation. That night, my home was filled with intense happiness, hope and prayer.

SIMPLE MIRACLES

The experiment I had proposed was amateurish in its simplicity. The small intestine dealt with foreign challenges from ingested food on a continuous basis. Mechanisms for immunologically dealing with harmful agents had to be dramatic, rapid and effective. Every time an organism entered our intestine, we did not have the luxury of mounting a slow response with temperature, lethargy and all the normal physiologic and metabolic features of an immune response. It had to be eliminated with prejudice and finality.

Neighbourhood lymphocytes in the blood and other organs

would never meet such overwhelming numbers of challenges, as several barriers needed to be passed first; their response therefore could afford to be more delayed. Immune cells from respiratory passages would also be expected to act rapidly, but they did not appear resistant to the spread and appearance of cancer. Peyer's patches would protect the small intestine against direct invasion from the large bowel cancers as well as blood-borne metastases. I reasoned that their cancer-killing ability should be visible within minutes.

Others in the laboratory were sceptical, and with reason. Data repeated from decades of studies indicated that it would take the incubation of 50,000 to 100,000 white blood cells for three days with cancer cells and immunostimulants for some of these cells to kill one cancer cell. The effect was often so subtle that radio-uptake and leakage studies had to be undertaken to detect differences. This involved incubating cancer cells with radioactive isotopes of an agent such as caesium, to allow the cancer cells to absorb it. When damaged, cancer cells would then leak the radioactive caesium and that leakage can be measured to indicate cell damage. I reasoned that the effect would be easily seen on light microscopy with oesin uptake. This technique is one where

a red dye is added to the cells. Living cells have an active pump system and patent membranes that stop dye entry, whereas damaged and dying cells would be coloured by the oesin.

Control studies using cells from Peyer's patches that had not been exposed to cancer, showed cancer viability close to 95 per cent. Spleen cells from unexposed animals did the same. Spleen cells from animals that had been carrying the cancer gave me a surprising finding of 100 per cent viability of cancer and an actual increase in cancer count after short-term incubation. It appeared that spleen extract from a diseased animal was actually promoting tumour

growth. I did not pay much attention to that finding at the time; I was searching for a cure, not riddles.

Cells from Peyer's patches of mice that had been carrying the cancer surpassed my expectations. As opposed to the 50,000 to 100,000 cells destroying one cancer cell as previously mentioned over a three-day period, it took one lymphocyte from sensitised aggregates to kill 400 cancer cells in a one-hour-or-less time period. The cancer cells would uptake the red oesin dye and soon collapse.

The experiment would be repeated over and over before I would let myself believe it, before I would show others. Exposed to a very small amount of Peyer's patch extracts, the cancer cells would turn red with embarrassment, then shrivel and die. Mass slaughter of an invulnerable enemy—it was intoxicating and delicious.

I beckoned for Dr Jose to review the carnage. With just a hint of excitement he exclaimed, "They're all dead!" He then added in standard clinical "Vulcan" coldness: "Interesting."

The following weeks were filled with more magic. Tests confirmed no toxicity to healthy cells from my lymphocyte extracts. They were able to protect animals against cancer inoculations, and single low-dose treatment was able to keep the animals living longer once they had the disease. Other cancer systems were tested, including the hepatoma rat model, with identical successes.

In that instant, I understood an intrinsic flaw in the cancer research industry. In order to realise easy acceptance of ideas and receive grants, it was important to show that you were travelling down the same well-worn path of prior investigations.

FADING DREAMS

I asked when this discovery could be put to use in terminally-ill humans. "Not for a long, long time," I was told condescendingly.

None of my colleagues or superiors in the laboratory seemed to share my excitement; worse yet, they seemed to resent my success—and me, too, for that matter. Perhaps their egos were bruised. I was often reminded that I had no formal training or education in the field, whereas they had *years* of it. My work at the Clinical Sciences Building (Royal Melbourne Hospital) and the Ludwig Institute became more and more isolated.

Other affiliates and collaborators who had donated animals and lab space to me included the Department of Biochemistry at Melbourne University. Dr Schreiber, the department head, called me in to advise me personally that in the few days I had been there I had created friction as I was not qualified, paid or a member of their 'group' and that structurally they could not support another worker. I had not fought with anybody, or argued or insulted anyone. I was unpaid and, above all, my work was yielding incredible results. How could they terminate investigation on such a promising avenue? These extracts were killing cancer more effectively and more safely than anything else in history!

"It doesn't matter," Dr Schreiber replied.

Dr Jose reminded me that publication was the only way for a scientist to achieve recognition, and offered me a poster presentation at the Clinical Oncology Society of Australia (COSA) annual meeting in 1981. Hopes rekindled; I prepared for the big time. Perhaps amongst doctors, the idea of an effective therapy would be better received than in the sterile field of research.

A few months later I was standing proudly by my poster; the youngest-ever presenter of an original project at the prestigious COSA meeting. Few people stopped by my exhibit and most did so only to advise me to leave research and concentrate on my medical studies. I was simply too young and naïve, they said. "What about the work?" I asked. "Interesting," they replied, and moved on.

Most people spent their time around a diagnostic antibody exhibit. The attractive researcher's mini-skirt and plunging neckline were also on exhibit. Hell, even *I* found myself distracted by her monoclonals!

I had come with aspirations of recognition, of encountering someone who would carry the investigation where I could not: in the human field. If I had harboured any illusions of discovery, fame or acceptance, they were quickly shattered. Scientists and doctors alike had greeted me and my discoveries with the same warmth one reserves for an acute attack of haemorrhoids or outbreak of herpes.

While I found the displays worthwhile, the conferences themselves were electrifying. I learned of new techniques being used and the latest trials of hormonal agents, immunostimulants and chemotherapy. Immunotherapy remained an exciting field, whereas the latest chemotherapy evaluations were delivered in gritty, realistic and defeatist manner. Hormones were finding increasing application in general disease management. Bone damage and pain in cancer such as multiple myeloma were shown to be preventable and treatable with anabolic hormones. Just that tidbit of information was worthwhile. It represented a concrete, usable way to help my father.

During the presentations I was to strike a friendship with an oncologist who would later do his best to destroy me. It would be a recurring theme of my life. My greatest enemies would always start as respected friends.

When I suggested to my father's oncologist that anabolic hormones be added to strengthen his bones and diminish his pain, he became annoyed. I had stepped on his toes by daring to suggest a therapy. Had I hurt his ego? Was there a better way to ask him? Who cares? I just wanted the best for my father. He refused to recommend it and my father refused to try anything his specialist did not recommend.

In one presentation I managed to offend my father's doctor and be ignored by virtually all others. I had presented a technology for curing cancer, and no one cared.

EGOS AND LIES IN THE HEALING ARTS

One of modern medicine's greatest achievements is the claim that no one needs to suffer, for there is supposedly no pain that cannot be eliminated by modern pharmaceuticals. That is perhaps true even in severe terminal pain, if one does not mind existing instead of living; existing with clouded perceptions, blunted emotions, a drug-induced stupor; a waking coma where you struggle to comprehend the world racing around you, where you try to communicate but mouth gibberish, where you dig deep, searching for the spark, the joy, the will to continue but find not even a memory of it.

This desperation, this depression, this torment, this torture is often the price paid for physical comfort. "We can prevent suffering in terminal disease" is a statement often made by a medical fool more concerned with perpetuating and reaffirming his illusions of godhood without any regard for reality.

Cancer is nothing if not relentless. Chemotherapy and radiotherapy had failed to arrest the progress of my

father's disease. As the multiple myeloma spread its physical domination, shattered my father's skeleton and destroyed his immune function, fractures, recurrent infections and pain, constant pain, became features of his life. As he lay bedridden with bone compression, multiple rib breaks and a disintegrating pelvis, my father refused painkillers except at night so that he could sleep. He would not permit any loss of mental clarity during his waking hours: time was short and he wanted to live it, experience it fully. With his body deteriorating, his mind remained the only undesecrated sanctuary, haven, drive to continue. He would not allow this most cherished possession to be tainted; he would not allow his loved ones to see him as anything less than the best he could be.

I was beginning to have major problems at medical school. I could not see the relevance of many topics, nor fathom the time-wasting techniques in teaching other subjects. We learned, for example, how to launch a projectile into orbit around Jupiter (useful knowledge if your practice caters for outer-space aliens and you wish to post them a prescription; of course that would necessitate a pharmacy on Uranus, which could prove uncomfortable). Plutonium purification in the manufacture of nuclear warheads was another priceless inclusion in our study of the healing arts. Important topics were noted by their absence. Preventive medicine was never discussed. In the late 1970s and early 1980s,

I was unpaid and, above all, my work was yielding incredible results.

These extracts were killing cancer more effectively and more safely than anything else in history!

when I undertook my formal medical studies, diet and nutrition were considered alternative heresy.

The study of anatomy was done in a particularly inefficient manner. We were given cadavers to dissect for two years. A group of eight students would spend hours, scalpels in hand, digging at a corpse, hoping to find and trace nerves and arteries to their origins and distributions. Dead bodies do not handle the same as living tissue, and rarely look the same as in book illustrations. I studied my anatomy from a book. Much more could have been learned had each group been assigned one person who was well-trained and who could have guided and educated us. My memories of these sessions are ones of the stench of formalin, of a student eating someone's biceps on a dare, and of others skipping rope using a corpse's small intestine or playing football with a hardened lung. This abhorrent lack of respect for men and women who had donated their bodies to science and medicine sickened me.

MEDICAL RESEARCH: STAGNANT, DIRECTIONLESS

In this era of genetic engineering and daily promises of medical marvels, it is hard to imagine a period where innovative thought seemed to be at a standstill; yet back then, as now, in the playing fields of clinical trials, one finds variations of intricate protocols and slight modifications of rules and tools to search for slightly improved responses from the same tired players: surgery, radiation and chemotherapy. This points to the stagnant nature of *real* options available to the public.

As a medical student, I was now becoming exposed to rigid, inhumane insanity often associated with clinical trials and questionable measures of success. Only in cancer, for example, would a chemotherapeutic agent being evaluated be considered a success if it shrank a cancer mass, even if it shortened patient survival.

Decades ago, hospitals had carried out unethical and repulsive procedures in the name of science. Pregnant women were injected with high doses of radioactive isotopes to gauge the effect on embryos; prisoners' testicles were irradiated to study changes; relatives were inoculated with patients' cancers to study their response (at least one case of cancer transfer and death of a patient's mother occurred).

Modern-day inhumanity was present, but not quite as overt. It lay in protocol objectives and structures.

I remember the case of a patient, a 22-year-old mother, who entered a monitored trial situation where she was slotted into the hormone-blocker evaluation group. This breast cancer study was designed to evaluate survival with various treatment options: surgery alone (localised), surgery alone (extensive), with radiation, with chemotherapy, with hormonal blocker therapy, with combinations of the preceding.

This data had already been gathered to reasonable precision from studies too numerous to mention worldwide, and certain guidelines for combinations had been enforced for many years. This particular design protocol did not allow for such flexibility. How could we achieve accurate readings if we contaminated one group with the therapy of another group?

The cruelty of the last statement could be seen in the plight of the patient referred to above. Having been assigned to the hormone group, other therapy was withheld—even when it became

obvious that it was not working, and spreading cancer had broken several bones in her spine. (This was not an unusual occurrence in breast cancer. The standard therapy of the time, which remains to this day, is the use of radiation to allow for fracture-healing and to resolve the associated pain. This was denied her; actually, never offered, for the 'sake' of the trial.) The insanity of this situation must be restated: this trial was confirming many others which had already outlined the relative merits of therapy. Why this theme of repetitive rediscovery of the known, regardless of human consequence? Because it gives the illusion of work, progress and motion in a stagnant cesspit of medical impotence.

In Australia, the natural health revolution had only just begun and was struggling for acceptance. The adamant claims of this new field of medicine were both inspiring and confusing. The response from conventional medicine was cutting. Alternative medicine was deemed fraudulent and rejected outright, its practitioners shunned and persecuted. Disgrace and deregistration awaited doctors who preached or practised its beliefs.

Supporters of this emerging field dealt in an inexact science, yet the detractors refused to carry out investigations to disprove the claims of alternative medicine. What resulted was a slinging match with a confused public as the victim. Patients were often punished if they saw a naturopath or asked a doctor advice on supplements; they would be treated curtly, and it was not unusual

for the doctor to refuse their ongoing care. New options had been thrust onto patients, yet proof of efficacy was as lacking as proof of inefficacy.

My mother and I had been searching constantly for anything in research, folklore or overseas programs. The sudden influx of claims from natural medicine brought a range of new modalities to try: mind power, herbs, vitamins, vegetarianism, macrobiotics. My father tried them all, to no avail.

Fasting, juices, meditation, simple do-it-yourself techniques with a universal appeal could restore a person's capacity to help themselves against a condition so foreign, so overwhelming that grown adults would revert to child-like dependency on their doctors. Even if only of marginal efficacy in the physical long-run, the psychological advantage of regaining some measure of control of one's life was a feature conventional medicine could not compete with. There was also a link that had only been hinted at previously. Alternative medicine heavily promoted the concept that proper activation of immune function could eliminate cancer—again, an empowering concept.

Perhaps in an effort to compete with the new challenger, or perhaps finally disgusted with the toxic failures called "standard therapy", the powers-that-be launched a major thrust into immunotherapy. I was part of the "IF" generation. Conventional medicine brought out a new warrior, an immunostimulant called "interferon"—the "IF" drug. I cannot claim to know or understand what changes the emphasis of investigative pathways in modern medicine, only to say that the industry is particularly well tuned to public views and needs. In the 1970s it was immune function, so interferon and interleukin occupied the forefront of research for a decade or so. In the 1980s the public cried out for natural medicine, so Taxol, a natural extract, was released.

My memories of these sessions are ones of the stench of formalin, of a student eating someone's biceps on a dare, and of others skipping rope using a corpse's small intestine or playing football with a hardened lung.

Continued on page 82

The AMA's Charge on the Light Brigade

The pioneer of a coloured light therapy able to cure a vast range of diseases, Dinshah was victimised for decades by the American medical establishment, but his 'underground' research is quietly resurfacing.

by Stuart Troy ©1997

For further information, contact:
Dinshah Health Society
PO Box 707
Malaga, NJ 08328, USA
Telephone: +1 (609) 692 4686
Web: <http://www.wj.net/dinshah>

The evils of some men have a karmic momentum that extends beyond the grave, undiminished by their deaths. If you could somehow quantify and accurately ascribe human pain and needless suffering, then the pernicious legacy of Morris Fishbein, MD (1889-1976) of the American Medical Association (AMA) would exceed in villainous ignominy the legacies of Hitler and Stalin combined. While a more subtle and quiet offence which may pass unnoticed in the historical moment, ideocide is ultimately, in its continually expansive accumulative enormity, a far more pernicious crime against *all* humanity than any 'simple' genocide. When a genocide indictment is finally issued, it contains specifics: dates of onset, locations, duration, victim identity lists. But who can name the victims or measure the pain that marks Fishbein's ideocidal career? Indeed, when can we even end the tally?

If the only adduced instance of Fishbein's ideocide were the persistent, obsessive persecution of Colonel Dinshah Ghadiali, MD, DC, PhD, LLD, from 1924 to 1958 and the attempted eradication of his Spectro-Chrome Therapy (SCT) both from practice and from print, it would tragically suffice to make my point.

Popular history would have us believe that the (now scandalously) shocking FDA-instigated incineration of the printed works of Dr Wilhelm Reich was an unprecedented and isolated event in these United States of alleged First Amendment protections.

However, the dubious distinction of having been the first Federal book-burn victim belongs to Dinshah. Ten years previously, in 1947, in compliance with a Federal Court order, he had to "surrender for destruction" his unique library and all printed material pertaining to coloured light therapies to US marshals in Camden, New Jersey. All during those years he remained steadfastly dedicated to truth in the healing arts, and to his personal vision of an earnest, energetic, open America (a vision he formed some 50 years earlier on his first visit). The source of this resiliency is found in part in his often-repeated motto: "Truth can be defeated, *never* conquered."

In the better-known case of Dr Reich, the very barbarity of the assault itself added to his mystique, imparting a legendary martyrdom and ensuring an elevated niche in history independent of the content or validity of his science. In contrast, very few, even among practitioners of the alternative disciplines, know the story of SCT despite the uninterrupted efforts of the Dinshah Health Society, established and run by his son Darius Dinshah on the original 23-acre Malaga, New Jersey estate. Operating under the strict confines of the final 1958 FDA (Food and Drug Administration) injunction, which is still in effect, SCT has somehow survived to enjoy the modicum of legitimacy conferred by the 1994 recognition and listing (as an information source only) of SCT by the US Office of Alternative Medicine.

Fortunately for us, the core of the system (any projected light source except fluorescent, plus 12 coloured filters) is so low-tech, and the "tonation" application formulations—laboriously determined and charted by Dinshah—are so simple that the ease of home assembly and utilisation allows for convenient accessibility. Unfortunately for Dinshah (the "Ghadiali" was dropped in America), it was precisely this low-tech accessibility and therapeutic efficacy which made him an irresistible and inevitable target for Fishbein and the healing-for-money establishment.

Born in Bombay, India, in 1873 to a Parsee watchmaker of Persian descent (the Zoroastrian faith to which he adhered is often referred to as "the Faith of Light"), Dinshah's special genius and industry soon became apparent. He began primary school at age three, and high school at eight. By his 11th year he was an assistant to the Professor

of Mathematics and Science at Wilson College, Bombay. His father did not encourage his early fascination with electricity, and Dinshah told of sneaking downstairs to study through the night, retiring for a few hours of sleep shortly before dawn when he and his father would arise together. He took his university exams at 14, winning proficiency awards in English, Persian and religion. (In his spare time, he was to achieve competence in eight oriental and eight occidental languages.)

The following year he divided his time between giving demonstrations in physics and chemistry and meeting the demands of running a successful electric doorbell/burglar alarm installation business. It was also the year he began his medical studies.

At 18, having mastered the practice of Yoga Shastra and having been awarded a fellowship by The Theosophical Society, he added spiritual subjects to his oratorical repertoire. His reputation and experience as an electrical engineer earned an appointment as Superintendent of Telephone and Telegraph for Dholar state. Three years later found him serving as Electrical Engineer of Patiala state and Mechanical Engineer for the Umbala Flour Mill.

His medical studies completed, in 1896 Dinshah made his first trip to America, where he lectured on X-rays and radioactivity, meeting Tesla, Edison and other scientific notables. A darling of the press, Dinshah was affectionately referred to by the *New York Times* as "the Parsee Edison".

The freedoms, the opportunities, the stimulating intellectual energies he perceived in pre-war America left him with an inspired, compassionate optimism that future events could not dilute. Upon his return to India he became a social reformer and the first Publisher/Editor of *The Impartial*, a weekly founded "to

further the cause of freedom in speech and writing".

The year 1897 was to prove pivotal, for it was the year Dinshah became the first person in India to apply and thus effect a cure for disease in accordance with the hypotheses of Dr Edwin D. Babbitt (as in his book, *The Principles of Light and Color*, University Books, New Hyde Park, NY, 1876, reprinted 1967) and Dr Seth Pancost (*Blue and Red Light, or Light and its Rays as Medicine*, 1877).

During the plague years of the early 1900s, Dinshah's eclectic and unorthodox ministrations effected a 60 per cent recovery rate, in contrast to the 40 per cent recovery expectations of conventional medical practice.

Responding to an influential Theosophist friend's urgent summons, Dinshah, from his supervisory position in a major light installation several hundred miles away from central India, travelled to the bedside of her aunt who was dying from mucosa colitis (dysentery). Upon arrival, Dinshah faced several handicaps. The attending physician of record was a prominent Parsee and the Honorary Surgeon of no less a personage than the Viceroy of India. The old woman revered him as a demigod, but contemptuously referred to Dinshah as "that kid doctor".

For three days he had to watch silently as her health continued to fail rapidly under a brutal but conventional medicinal regimen. Although the regimen was well thought out and in conformity with the best recommendations of *The British Pharmacopaedia*, Dinshah saw that the opium administered for the pain was stressful to the heart; the catechu, although a good astringent, was a peristalsis inhibitor; the chalk, intended as a binder, was an intestinal irritant; the bismuth subnitrate, a local antiseptic, choked the alimentary canal; and the anti-flatulent chloroform was escharating damaged tissue.

As Dinshah noted:

"Thus she stayed two days more, drinking the poisonous concoction. On the third day she was in such a condition that she lifted her hands to me and implored me, 'O Dinshah, save me!' Medically she was beyond recovery and I said with a sigh, 'Call on the Almighty to save you. Dear girl, I have no power, no medicine of which I know I can be of service to you, but if you let me I shall endeavour to do the best otherwise.' She nodded her consent and promptly I threw out the drug mixture... Here was my opportunity to test the chromotherapy of Edwin D. Babbitt. The woman was dying—she was anyhow as good as dead. I could not kill her further if I failed... I brought [indigo-] coloured pickle bottles to act as the slides... Within 24 hours the [100 daily bowel evacuations] were reduced to four a day; within 48 hours they came down to two; the third day Jerbanoo was out of bed!"

Reflecting an Eastern patience and restraint, and reflecting the slower technological pace of a pre-electronic age, Dinshah did not rush impetuously into print. However, before he could publicly promote SCT he had to be satisfied that he could exercise confident control of the procedure. Thus Dinshah embarked on a lengthy theoretical research project, producing remarkably precise and accurate tonation formulations.

By 1904, at Ajmer and Surat, he had established "Electro-Medical Halls" for the promotion of colour therapy research, magneto- and electro-therapeutic approaches as well as orthodox medicine. However, early on he was forced to abandon the otherwise promising electric modalities due to frequent episodes of nerve anastomosis and the inherent and insurmount-



Dr Dinshah P. Ghadiali (1873-1966)

able problems he encountered with "unmanageable and freaky currents".

In 1908 he left India to promote his inventions through Europe, eventually, in 1911, dropping anchor in the US with his (first) wife and two children. He loved America and vigorously embraced the principles and politics of an open democracy. However, the same cannot be said of his wife who, in reaction to her early years of impoverishment and perhaps more than a little culture-shocked, returned alone to India.

Dinshah was so taken by his vision of a Walt Whitman/Horatio Alger America as perceived in those pre-war years that in 1914 he turned down a private offer of US\$100,000 for his Internal Combustion Engine Fault Finder which he developed while serving as Professor and Chief Instructor at the New York College of Engineering Science and Automobile Instruction. Instead, he gave all rights to the US military for aviation application. (Amongst his patented inventions are: #983,703, Electrical Wiring Device, 1911; #1,144,898, Automobile Internal Combustion Engine Fault Finder, 1915; #1,544,973, Color Wave Projector, 1925; #1,724,469, Electric Thermometer, 1929; #2,038,784, Color Wave Projection Apparatus, 1936.)

Dinshah was granted US citizenship in 1917. The following year he was given a commission as Captain in the New York Police Department Reserve, and in recognition of his wartime civilian aeronautic harbour-patrol activities he was promoted to Colonel, awarded the Liberty Medal by NYC Mayor John Hyland and appointed head and principal instructor of the NYPD Aviation School. The banner year of 1919 found him a member in good standing with the American Association of Progressive Medicine, and the elected Vice-President of the Allied Medical Association of America and the National Association of Drugless Practitioners.

This all seems a strange background for a "charlatan" and "huckster", as he was to be labelled and pilloried by Fishbein's AMA, in conjunction with the equally acquiescent, ever spineless FDA (Food and Drug Administration) in the decades that followed.

Something insidious and unnoticed had happened during the 24 years since Dinshah's first visit to America. The robber barons of the 19th century had discovered value in technology and proceeded to exercise the same piratical control over intellectual property as they previously had over the traditional sources of material wealth. Lights dimmed all over the shortlived Age of Enlightenment as new acquisitional and inquisitional institutions became empowered and entrenched.

Social historian and author David Lindsay (*Magnificent Possibilities*, Koodansa America, Fall 1996) notes that with the change of the century there was a change in the perception of the technical man, the inventor. New social forces coalesced, mediating direct contact between people and technology. The control and credibility that had been the scientist's were co-opted by agencies of industry working with agencies of government.

Canadian political scientist Andrew Michrowski fixes the date with even more precision: "It was possible for Nikola Tesla, Alexander Graham Bell and George Westinghouse to make their mark because in their time, before 1913, the retardant forces were not yet organized enough to totally counterweigh their innovations."

Suffice it to note that 1912 was the year that young Morris Fishbein, MD (*sic*) (neither passing anatomy nor completing his residency), entered the employment of the already disreputable American Medical Association, without ever practising medicine. In 1913 he became Assistant Editor of the AMA's journal, *JAMA*. A prolific writer of articles, editorials and, later, books crusading for the medical profession, Fishbein became Editor of *JAMA* and

Hygeia in 1924, holding these two posts for 25 years.

So it was against this background that Dinshah, ignorant of or indifferent to this dawning of a New Age of Darkness, innocently went public with SCT in April 1920 in New York City. The first formal instruction, in December that year, was attended by 27 students. During the next four years (as Morris Fishbein consolidated his political power within the AMA) Dinshah held 26 classes, training over 800 students, predominantly physicians but including many lay trainees as well.

It was the very ease with which the correct tonation could be determined and applied by laymen in the privacy of their homes (as much as, if not more than, mere efficacy) which constituted the true threat. If Dinshah had kept the SCT technology arcane, the equipment expensively overdesigned and within the preserve of the professional health community, events would have played out quite differently. Unquestionably it was this accessibility and the consequent commercial threat which SCT represented that made Dinshah an early target for an eager Fishbein.

Fortunately for Dinshah, an early attendee was the 23-year-tenured Chief Surgeon of the Woman's Hospital of Philadelphia, the highly credentialled Kate W. Baldwin, MD, FACS, a member of the AMA and the Pennsylvania Medical Society, and the first woman in the American Academy of Ophthalmology and Otolaryngology. Until her death in 1937, she remained a private SCT practitioner and a vociferous advocate in public, frequently defending SCT and Dinshah against the dark forces of repression.

Dr Baldwin enjoyed sufficient status and seniority that the initial anti-light-therapy onslaught could only incommode but not intimidate or destroy her. Indeed, so forceful was her presence and so unequivocal her defence testimony at Dinshah's first trial in 1931, that the government refrained from any prosecution of Dinshah—on the basis of science—during her lifetime.

In 1921 Dr Baldwin arranged for Dinshah to lecture in Philadelphia. Eventually her brother, the equally eminent surgeon L. Grant Baldwin, MD, FACS (Mayo Clinic), was to introduce several SCT units to his Brooklyn, NY, practice.

Some of the social (political) history of SCT is to be found preserved in the meagre, but reliable, regular Minutes of the Board of

During the plague years of the early 1900s, Dinshah's eclectic and unorthodox ministrations effected a 60 per cent recovery rate, in contrast to the 40 per cent recovery expectations of conventional medical practice.

Managers of the Woman's Hospital of Philadelphia. Over the next five years these records were to suggest even more than they revealed.

Dr Baldwin's request to address the Board on her in-patient SCT work was granted, and on 21 December 1923, according to the Minutes, she "gave an illustrated account of the wonderful work done in the Hospital with the spectrochrome [*sic*]. She described a remarkable case of a child...so badly burned that there seemed no hope of her recovery. With the use of the Spectrochrome [*sic*] [primarily using the colour turquoise, i.e., blue plus green], the child is almost entirely cured. It is such an unusual case that the Board feels it should be written up for publication by Dr Baldwin... The Spectrochrome is used in no other hospital and *credit should be given to Dr Baldwin for developing its use here. There are four instruments in the Hospital and more could be used if the room were larger.*" [Author's emphasis in italics.]

It was but a short five weeks later, in the 26 January 1924 issue of the *Journal of the American Medical Association (JAMA)* (which had just recently fallen under the editorial control of Fishbein), that the first salvo was fired: a lengthy, baseless denunciation of SCT, complete with a defamatory attack on the character of Dinshah and, by associative implication, all SC therapists—with explicit reference to Dr Baldwin, who, among numerous physicians, had been regularly contributing case histories to Dinshah's *Spectro-Chrome* monthly journal (which he published from 1922 to 1947). The *JAMA* article concluded:

"Some physicians, after reading this article, may wonder why we have devoted the amount of space to a subject that, on its face, seems so preposterous as to condemn itself. When it is realized that helpless but credulous patients are being treated for such serious conditions as syphilis, conjunctivitis, ovaritis, diabetes mellitus, pulmonary tuberculosis and chronic gonorrhoea with colored lights, the space will not be deemed excessive."

While it took four years for Fishbein finally to bring Dinshah before his first magistrate, the first blood had been drawn much earlier. Two months after the *JAMA* article appeared in print, the Woman's Hospital Board of Managers' Minutes of 28 March 1924 report the receipt of a letter from the staff, requesting that Dr Baldwin discontinue the use of SCT. The only ground offered for this initiative was the *JAMA* article. The Board's time-tested response was the classic bureaucratic reflex: an ad hoc committee was established to evaluate the situation for later discussion.

Not all the Board's problems conveniently faded during this interval and it was forced to address the issue head on. According to the Minutes of 23 May 1924: "...the question had been considered from every viewpoint and...the Committee recommended the continuance of present conditions. This report of the Committee was accepted." [Author's emphasis.]

Almost a year later, the Minutes of 27 March 1925 record that, "Dr Baldwin in a letter spoke of her need of more room for the Spectrochrome. She asked to have two cubicles made; she is getting many cases..." Subsequently Dr Baldwin was permitted to install additional treatment cubicles.

Notwithstanding all of these initial successes, buttressed by the consistent clinical evidence, official affirmations and institutional support, SCT was soon to suffer the first of a nearly unbroken string of reversals. There is a subtle but interesting peculiarity to this sudden, decisive turnabout spontaneously appearing in the Minutes without warning. True, the Minutes give no picture of day-to-day hospital politics, and given their narrow purpose and focus, especially as the sole historical source, they would of course tend to conceal more of a general contextual circumstance than they could reveal.

So we are left to speculate on the strangeness of the impudence of a letter from the *hospital interns*, received by the Board and reported in the Minutes of 24 September 1926, expressing their objections to Dr Baldwin's presence on the surgical staff.

Traditionally interns, from a socio-political perspective, constitute the least vocal and effective participants in hospital policy formation. However, one can perhaps understand, even sympathise with the interns' position, with their cumulative daily frustration as endless streams of serious surgical candidates and other diseased patients were regularly being sent home without ever seeing a knife or pill.

What is less understandable is the effectiveness of their one letter.

The September meeting moved to request Dr Baldwin's resignation from the surgical staff, but also moved that she "be granted the privilege of practising Spectro-chrome Therapy with her private patients in the Woman's Hospital." Both motions were carried.

The Board passed on the request to Dr Baldwin, and by the meeting of 22 October 1926, without record of internal debate or explanation, the Board accepted "with regret" Dr Baldwin's resignation from the surgical staff.

"She described a remarkable case of a child...so badly burned that there seemed no hope of her recovery.

With the use of the Spectrochrome [primarily using the colour turquoise, i.e., blue plus green], the child is almost entirely cured."

Just before Dinshah's first trial in 1931 in Buffalo, Erie County, New York state, Dr Baldwin received a letter from the Secretary of the Erie County Medical Society specifically soliciting her comments about the 1924 article and the impending criminal action.

The letter read:

"According to [the *JAMA*] article, Susie T., age 9, who was admitted to the Woman's Hospital with a sloughed appendix and peritonitis, developed a pneumonia which was treated by Dr Baldwin with lemon, turquoise and magenta colored lights. Susie went home well and happy.

"Dinshah P. Ghadiali, using the title M.D., is the publisher of *Spectro-Chrome*. He is under arrest in Buffalo charged with grand larceny for selling a course of lectures and leasing a colored light apparatus of alleged curative value for human ailments.

"We are wondering if the article in which your name is

given is a correct statement. Our Society is somewhat interested in the outcome of this case and we will very much appreciate your telling us if your name was used with authority."

Dr Baldwin's ringing endorsement was but faint indication of the eye-opening testimony she would soon deliver under oath.

Her reply read:

"Your letter of June 9th is just received. The statement printed in the *Journal of the American Medical Association* of January 26th, 1924 is practically as written by me for *Spectro-Chrome* magazine. Susie's was an emergency operation at nine o'clock at night. There was nothing left of the appendix to remove. There were quantities of pus. The wound could not be closed, free drainage was provided and the child put to bed with little hope that she would live until morning. For some days, an enema would simply pass through and out of the abdominal opening. Susie did develop pneumonia. I did use Spectro-Chrome and eventually she did leave the hospital in good condition.

"In the Woman's Hospital, I used Spectro-Chrome for many things to the satisfaction of the patients, the staff and the Board. The results were approved by all interested, until the article cited came out in the *Journal*. Then the staff turned traitor. The Board appointed a Special Committee of five to investigate, and a copy of its report I am enclosing. After this investigation I was granted a large space for the work of Spectro-Chrome.

"The American Medical Association continues to rate me as a Fellow in good standing. *Not the slightest effort to prove the truth has ever been made by the AMA or the doctors. The simple fact that the AMA made the statement against Spectro-Chrome was sufficient to condemn.* At the time I wrote to the *Journal* stating facts. The courtesy of a reply was not granted. The letter was sent by registered mail and a return card showed that it was delivered. Eventually this article was the cause of my losing my position on the surgical staff of the Woman's Hospital.

"The AMA has not been just to one of its members or to humanity; within the year of 1929, communications have been sent by the AMA to several of my patients in the shape of a reprint of the article published in the 1924 *Journal* and a letter ridiculing Spectro-Chrome and me.

"*Spectro-Chrome has more value as a therapeutic measure than all the drugs and serums manufactured. I would close my office tonight, never to reopen, if I could not use Spectro-Chrome.*" [Author's emphasis added.]

Dinshah was to face tribunals eight times, winning vindication only twice and having to serve a total of 18 months in prison. His first victory, at Buffalo, NY, in 1931, was the last time the anti-light forces dared expose themselves to a decision rendered by a jury allowed to hear medical evidence and expert scientific testimony. His second victory (the first Camden trial, 1934) rested on the judicial reasoning that, being of Parsee descent, Dinshah was "a white man" and therefore, 17 years after his naturalisation, he was ruled to be not deportable.

Just as, in retrospect, the involvement of the normally non-influential intern role in efficaciously precipitating Baldwin's predicament seems to be more than meets the eye, so too is the circumstance that led to Dinshah's arrest in May 1930. The indictment charged that he "did feloniously steal \$175 from one Houseman Hughes by falsely representing and pretending that a certain instrument and machine [Spectro-Chrome] would cure any and all human diseases and ailments."

Again, the reliable Court record here gives scanty insight. Looking back at the actually ascertainable, there is reasonable inference that Hughes was only a point man—but for whom? He was a layman who had admittedly never received, witnessed or administered a tonation treatment. Affidavits and testimony from official records show only that he leased a unit (subsequently defaulting on the payment) and promptly pressed charges. There is no indication that he even removed it from the box. Someone on the prosecution side did turn it on, although did not take advantage of the exercise to attempt a tonation.

The core of the embarrassingly underprepared prosecution (what could they actually say?) was the "expert" testimony of a physicist who testified to the fact that the unit used an ordinary light, projected through ordinary coloured glass filters, producing no spectral alterations nor new rays of any sort. This was rather extraordinary testimony, considering that Dinshah had never claimed otherwise!

(This 1931 trial was also the last time the government was to base any indictment on its "ordinariness". Later, when the FDA, in a convenient about-face, proclaimed the Spectro-Chrome a "medical device" (though unauthorised), it provided the cloak of legality under which they conducted, unopposed, hundreds of warrantless, confiscatory and non-compensatory raids through the living rooms, basements and converted garages of otherwise innocent, non-complaining citizens after 1947.)

Dinshah, despite facing a looming 10-year/\$10,000 adverse judgement, chose to defend himself with a five-witness defence which included three MDs. He reasoned: "The judge knows the law and I know my science so I can defend it better than any lawyer. Truth can be defeated but *never* conquered."

Unprepared for an impregnable defence, the state produced in its rebuttal its only medical witness: Albert Sy, MD, a practitioner of the high-tech, expensive and generally inaccessible treatment modalities of radium, X-ray and ultraviolet irradiation. This prosecution witness, also testifying to his zero experience with SCT, was forced to admit under oath that he had *no* evidence at all for his "expert" opinion that there "could be no therapeutic value of colored light or other appreciable effect on animals".

Dinshah's first witness, Dr Welcome Hanor, an early SCT student and enthusiastic proponent, had posted the \$1,500 bail. His modest credential was his reputation as a local general practitioner of 30 years' experience. He gave unreserved credit to SCT for his successes with cancers, diabetes, gonorrhoea, syphilis, ulcers, neuritis, meningitis, heart conditions and many other disorders.

Dr Martha Peebles had a distinguished 24-year private practice in New York where she had also held public office with the City Department of Health before serving with General Pershing's expeditionary forces (attending up to 61 operations a day).

...a local general practitioner of 30 years' experience...gave unreserved credit to SCT for his successes with cancers, diabetes, gonorrhoea, syphilis, ulcers, neuritis, meningitis, heart conditions and many other disorders.

Invalidated by crippling arthritis and neuritis, her health was restored one month after receiving her first tonation treatment from Dr Baldwin, and she subsequently re-established her medical practice. In court she recounted her success with cancers, hypotropic arthritis, poliomyelitis, mastoiditis, sciatica, heart disorders, goitres, ulcers, neuritis *and many other disorders*.

Dr Kate Baldwin's testimony was extensive, forcefully unequivocal and unshakeable. The worst nightmare of a prosecuting cross-examiner, she repeated affirmatively as to SCT's efficacy in the treatment of cataracts, glaucoma, acute eye infections and haemorrhaging; mastoid and middle-ear problems; tonsillitis and adenoidal disorders; tuberculosis, bronchitis and pleurisy; functional and organic heart disorders; ulcers, haemorrhoids, boils, drug addictions, asthma, laryngitis, mouth disorders, rheumatism, lumbago, syphilis, cancer, radiation burns, appendicitis, strangulated hernia *and many other disorders*.

The trial lasted for four days before the jury returned the "not guilty" verdict in 90 minutes. Subsequently (in addition to his previous loss in Portland in 1928), Dinshah was to lose actions in Cleveland, Wilmington, Washington, DC, Brooklyn (the decisive FDA ruling) and, finally, in Camden in 1947.

By 1941, mail sent to Dinshah's institute was being returned by the local postmaster, marked "Fraudulent: Mail to this address returned by order of the Post-Master General." No doubt this purely postal administrative decision, not the result of a judicial proceeding, contributed measurably to the recognition of the AMA as a para-governmental agency of intimidation, and hastened the final discontinuance of SCT by the dwindling number of loyal MD practitioners.

Through an internal restructuring and reorganising at the Spectro-Chrome Institute, Dinshah was for a while able to circumvent and neutralise the mail blockade. Suffice it to note that Dinshah's manoeuvre was a shortlived expediency, lasting six years until 1947.

While looking back on Dinshah as an exemplar of indefatigable, persevering resiliency and inner strength of character, in balance we must also note with all due respect the persistence, long memory and vindictive, single-minded purposiveness of the private professional associations, in concert with government regulatory agencies, now legislatively armed to dispose of the inconvenience of the evidences and protocols of both court and clinic.

No narrative, historical reportage or creative mythology of suppression and censure, however factual or fantastical, is complete without the obligatory, timely, lab or library fire under suspicious circumstances. To paraphrase Cervantes very loosely, a tale of "intellectual inquisition" without arson is like a meal without wine.

The 1945 fire that destroyed Dinshah's main building, just 90 days before the Brooklyn trial, caused inestimable damage not just to his defence but to all of us through the destruction of demonstration prototypes and the irreplaceable case histories of 25 years.

Losing the second Camden trial (the FDA-driven action on "mislabeling") in 1947, Dinshah was fined \$20,000 and sentenced to a five-year probation period, a condition of which was to "sur-

render for destruction" *all printed material* (save some personal notes) pertaining to coloured light therapy—a singular collection valued then at \$250,000. He was further ordered to disassociate himself from any research in the field.

Probation completed in 1953, Dinshah again restructured his institute, this time as an educational institution, Visible Spectrum Research Institute, and resumed the dissemination of information and equipment—but with a disclaimer asserting that "in accordance with the current conventional medical view, there is no curative, therapeutic value" to these projection systems. Independent of any SCT/Dinshah data, this scientific "edict" was already known to be false. (In 1958 the FDA finally obtained the permanent injunctions, still in effect today, under which Dinshah was to operate until his death in 1966, at the age of 92.)

Contrary opinions such as those of the establishment-respected A. J. Ochsner, MD, FASC, author of still-classic surgical textbooks, could again be made weightless by edict. Writing to no apparent effect in those days, he reported:

"In a personal experience with septic infection, the pain was so severe that it seemed unbearable. When the use of electric light was suggested, it seemed unlikely that this could act differently from the other forms of therapy that had been employed. Upon applying the light, however, the excruciating pain disappeared almost at once, and since this experience we have employed the light treatment in hundreds of

cases of pain caused by septic infection, and quite regularly with results that were eminently satisfactory, not only in relief of pain but also because the remedy assists materially in reducing the infection."

There is little comfort to be taken from the fact that half a century separates us from those distant, dark ages of book-burning in America. The relation of phototherapies to the medical mainstream has not much improved. The dynamics of the relationship, the rules of combat

are unchanged. Large and loud, unapologetic denial; unembellished, unforgivable, inexplicable and dangerously erroneous counter-factual utterances are still being recycled by the usual bunch of high-prestige suspects.

For example, the highly regarded *Cancer Journal for Clinicians (CJC)* in 1994 (44:115-127), in an *anonymous* diatribe, characterised the World Research Foundation (WRF) (41 Bell Rock Road #C, Sedona, AZ 86351, USA) as "helping people locate questionable cancer cures... [and has] touted the Spectro-Chrome device". It then astonishingly concluded: "There is no scientific evidence that shining colored lights on the body will produce any biological effects."

This must come as quite a shock—to the generations of the paediatric health community who, for half a century, have routinely been treating the jaundice (neonatal bilirubin imbalance) of premature babies with the spectrally rebalanced, blue-enhanced, Westinghouse maternity bulb; to the generations of commercial breeders of chickens, chinchillas and fish who, for half a century, have been using the monochromatic reformulation work of pioneer John Ott (the original champion of full-spectrum light) to

...in 1947, in compliance with a Federal Court order, [Dinshah] had to "surrender for destruction" his unique library and all printed material pertaining to coloured light therapies to US marshals in Camden, New Jersey.

Continued on page 83

THE RICHARD CLEM ENGINE

by Jerry W. Decker

A few months back, we got a call from a friend who had heard of this incredible motor that was said to run itself and generate excess usable power. The details were unclear at the time, but our friend gathered more details and we met for lunch to discuss what he had found out.

As we understand it, inventor Richard Clem died of a heart attack soon after the deal was signed with the coal company. His workshop was raided by law enforcement officials and all his notes and drawings were removed.

The story as told by our unnamed friend:

A local man from Dallas developed a closed-system engine that was purported to generate 350 horsepower and run itself.

The engine weighed about 200 pounds and ran on cooking oil at temperatures of 300°F. It consisted of a cone mounted on a horizontal axis. The shaft which supported the cone was hollow and the cone had spiralling channels cut into it. These spiralling pathways wound around the cone, terminating at the cone base in the form of nozzles (rimjets).

When fluid was pumped into the hollow shaft at pressures ranging from 300 to 500 psi (pounds per square inch), it moved into the closed spiralling channels of the cone and exited from the nozzles. This action caused the cone to spin. As the velocity of the fluid increased, so did the rotational speed of the cone.

As the speed continued to increase, the fluid heated up, requiring a heat exchange and filtering process. At a certain velocity, the rotating cone became independent of the drive system and began to operate of itself. The engine ran at speeds of 1,800 to 2,300 rpm.

Immediately after the inventor had the heart attack and the papers were removed, the son of the inventor took the only working model of the machine to a farm near Dallas. There it was buried under 10 feet of concrete and has been running at that depth for several years.

In later conversations, our contact says the engine had been tested by Bendix

Corporation. The test involved attaching the engine to a dynamometer to measure the amount of horsepower generated by the engine in its self-running mode. It generated a consistent 350 hp for nine consecutive days, which astounded the engineers at Bendix. They concluded the only source of energy which could generate this much power in a *closed system* over an extended period must be of an atomic nature.

Construction of the engine was from off-the-shelf components, except for the hollow shaft and the custom cone with the enclosed spiral channels.

Richard Clem worked with heavy machinery for the city of Dallas and had noticed that certain kinds of high-pressure pumps continued to run for short periods after the power was removed. His curiosity into this phenomenon led to the development of the Clem Engine.

Vegetable-Oil Engine, 1972

The following is from a newspaper clipping that has no name or date.

"In 1972, Richard Clem announced the invention of a way to operate automobile engines on cooking oil. He's still making that claim today, even though his first prototype motor fell apart and he had been 'strung along' by at least 15 companies before he found financial backing.

"Clem, 48, a heavy-equipment operator for the city of Dallas and part-time inventor, says if the automobile industry adopts his invention, motorists could change the

eight gallons of vegetable oil only every 150,000 miles and never buy any gas.

"Clem said he uses vegetable oil because his motor runs at 300 degrees—a temperature where water has boiled away and conventional motor oil breaks down. Though he won't divulge many details of the engine, a 12-volt battery apparently is the only other source of power.

"When Clem finished his first vegetable-oil engine in 1972, he mapped a 600-mile test trip to El Paso for the first engine model he had financed through his earnings. But he only made it as far as Abilene before the 'shafts and everything bent in it'.

"He blamed the failure on poor construction, too small a shaft and the use of chains instead of gears. Undaunted, he decided to try again, but said, 'I needed money to build this thing better.'

"Neither the automobile industry nor the 15 other companies he wrote—some as far away as Taiwan—were interested in financing a prototype and then manufacturing it. Then last year, he said, a large coal company offered to back him. Clem refused to disclose the name of his benefactor, but did say the coal company had signed contracts to sell the engines to power companies for use in pulling turbines.

"Clem said he expects to finish work on the motor by the end of this year."

Update as at Nov-Dec 1992

The above article was reported as being

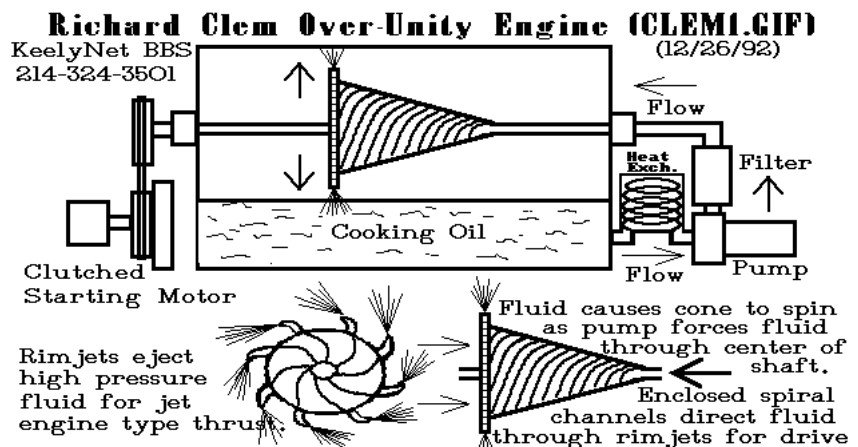

NEWSCIENCE NEWSCIENCE NEWSCIENCE

generated from Flower Mound, Texas (northwest of Dallas and slightly beyond Carrollton). I called the only Clem listed in the book as of 20 Nov '92, and they knew of no other Clem in that area, nor did they know of any Richard Clem or his family.

Two separate visits to the patent section of the Dallas Library have not yielded any patents by a Richard Clem involving any type of engine. We are still pursuing for more details.

As of 26 Dec '92, I drew up a .GIF file, CLEM1.GIF, that is bundled with this file under the name CLEM2.ZIP (see diagram on previous page). It gives a better understanding of how the machine was constructed, at least as it was described to us.

For those who study such matters, one immediately sees the tie-ins with "boundary layer drag" principles as evinced in much of Tesla's work as well as Victor Schauburger's "impansion" and "implosion" discoveries.

We have noted something odd about spinning masses, in that at specific velocities strange things occur. The velocities at which phenomena occur are dependent on the resonant frequencies of the mass as an aggregate, exactly as Keely said.

The Clem system was said to be built with off-the-shelf components. The most complicated piece of the entire machine was the cone. And based on boundary layer drag, it would seem that the cone was unnecessary.

The question with the Clem device is:

Does the extended surface area of the cone add to the additional velocity of the cone, yielding greater pressures through centrifugal force, or would flat plates as in the Tesla turbine be sufficient to generate the same effect?

We continue to look for more information on this device, and appreciate your comments or supporting material.

Update as of May 1996

A company called Creative Sciences is selling plans (US\$60) for what they claim is a machine that generates 1500 hp and runs by itself. They call this a "CEACU" and claim it was released by a 70-year-old retired scientist.

The truth of the matter is it was designed and built by the late Richard Clem of Flower Mound, Texas, as documented by this paper.

The CEACU design does not require the cone, but instead uses a thick disc with nozzles on the outer edge. A hollow shaft feeds water into this disc at a high velocity.

As the water exits from the nozzles, the disc spins, giving an ever-higher velocity. A 3,200 psi air tank is used to get the disc spinning to 1,000 rpm when it is claimed to begin to run on its own. There are other ways to achieve this velocity beyond 3,200 psi, as you can well imagine.

The address for Creative Sciences is:
Creative Sciences Research
PO Box 8001
New Albany, IN 47150, USA

Latest Info on the Richard Clem Engine

This past week, a new contact from the Roundtable meetings went out with some of us for dessert after the meeting. We discussed a wide range of topics, and somehow Richard Clem was mentioned.

This fellow said he actually *knew* Clem, had met him personally a couple of times, and had some additional information about him which he would gladly contribute to the pool.

Clem had a daughter and son, whom our contact says meet often at a restaurant/bar in a suburb of Dallas. So we will be pursuing a contact with them, even though they were *very* spooked by the events leading up to and after their father's death, which might make some bridge-building necessary.

When the FBI comes in and takes all your father's papers and work, I think I'd be paranoid, too. Our contact said Clem often drove the test car up and down Central Expressway in Dallas, back when there was nothing but open fields in the 1970s.

In seeking details or verifications of what we already had collected, our contact said Clem worked for the city of Dallas and operated heavy equipment.

This we knew; however, he said Clem used asphalt-spraying equipment which used melted asphalt that was pumped through the machine.

Clem noticed *this machine* would continue to run for up to an hour even after the power was turned off!

The reason Clem never applied for a patent was because his design was basically the same as the asphalt sprayer, and so he felt he could not infringe on an existing patent.

That is the first key difference: it was a hot asphalt sprayer rather than a fire engine pump.

The second key difference from our original information was that the axis of the cone was *vertical*, with a horizontal spin plane. This had been suggested by many, but we presented the information as it was given. Now it makes even more sense, because the gravity gradient would be slightly greater and amplified by the expanding centrifugal rotation.

Clem's machine used Mazola cooking oil and ran at about +300°F. He also used a heat exchanger to keep it cool. So we have a temperature differential plus the centrifugal thrust.

(Source: Posted 5 July 1996 on KeelyNet, <http://www.keelynet.com>)



VACUUM ENERGY A BREAKTHROUGH?

by Andrei Samokhin

The model of a plasma generator which can convert physical-vacuum energy into electricity has been developed under Professor Alexander Chernetski at the Moscow Georgi Plekhanov Institute of the National Economy, Russia. Such generators could lay the groundwork for the future environmentally-benign power industry.

Classical physics cannot explain what happens when a plasma discharger placed in the Chernetski circuit is started: for no apparent reason the ammeter pointer shows triple strength-of-current increase and energy output is several times above input. The plant's efficiency is much more than unity.

No magic is intended. Additional energy outputs at specific plasma discharges are fixed in several independent expert reports by the Lenin All-Union Institute of Electrical Engineering. This effect has been checked by different methods.

Whence this mysterious energy?

Self-Generating Discharge

Prof. Chernetski, the author of the first-ever study paper on plasma-diagnostics equipment (he has been in this field for 40 years now) and 20 inventions, never knew what he was probing into specific unstable plasma states at strong-current discharges could have led to. In the early 1970s, he and fellow researcher Yuri Galkin worked on a basically new type of high-frequency plasma generator which, at high power, could do without unwieldy energy converters. In one test, they discovered input-output energy gap.

"I knew electron drift begins in plasma, and sought to deduce a combination of variables in which fluctuating plasma instability emerged in discharge," Chernetski says. "Gas discharge was meant to serve as a powerful stimulator of electromagnetic modes and, all of a sudden and in defiance of the law of conservation of energy, a strange energy imbalance was produced. Repeated experiments with different circuits proved energy output to be always greater than input."

The mysterious discharge stimulating additional energy extraction was called the "self-generating discharge" (SGD). Measurements showed that part of the discharge power went back into the network as if two series-connected electromotive forces were at work.

In a bid to try to explain the experimental data, the researchers actually tried to prove the impossible. One of their proofs was very "strong".

The one-megawatt substation of the Moscow Aviation Institute, where Chernetski and Galkin were staging an experiment with a powerful plasma unit, burned out.

When the discharge currents reached criticality, superstrong current was "born" in the generator and went back into the network, playing havoc with the safety devices calculated for short-circuit.

Later on, they read in books that earlier in the century the power plant of prominent Yugoslav electrical engineer Nikola Tesla caught fire under similar circumstances in the United States. Chernetski and Galkin were sure that Tesla was making such experiments but did not publish the results. They are also sure that vacuum energy can explain this mysterious effect.

A Vacuum-Powered Lamp

The researchers relied on the present-day quantum physics idea of "zero-point oscillations" in physical vacuum. Such oscillations signifying the birth and annihilation of virtual pairs—the particle and anti-particle, distinguished from the normal elementary particles by a negligibly short life—a mere 8.10^{-21} [sic] seconds [8×10^{-21}].

Emerging below the zero-energy level from 'nothing' and returning to 'nothing', virtual particles appear to defy the law of conservation of energy.

Quantum electrodynamics explains this paradox through the Heisenberg uncertainty principle. Under it, all the precise particle characteristics cannot be learnt simultaneously, and therefore one must not require from nature 'punctual' abidance by the law during such a short time as the life of virtual pairs.

The observer fails to notice anything, while every virtual pair is more than real, carrying an energy of more than

half-a-million electron-volts during its lifetime. The potential energy in the electric-bulb vacuum is enough to boil the Earth's oceans, as Americans John Wheeler and Richard Feynman have calculated.

Until recently, the vacuum energy idea was only a daring hypothesis bordering on science fiction. The lamp powered by vacuum in Chernetski's basement laboratory in the centre of Moscow made it a reality.

This is how he explains his miraculous experiment:

"The self-generating discharge emerges when the discharge current reaches a definite critical density, when the magnetic fields they create ensure magnetisation of plasma electrons and they begin to perform mostly cycloid movements.

"The interaction of currents with their magnetic fields forces the electrons to deviate to the cylinder-shaped discharge axis, and the electrical field emerges. It has proved to 'switch on' the physical vacuum: in this field the vacuum is polarised, and consequently the virtual pairs begin to move in a definite direction instead of chaotically. The virtual positrons accelerate plasma electrons, giving them part of their energy.

"The current in the circuit builds up and additional energy is discharged on the resistor switched into the discharge circuit. Clearly, only part of the tremendous vacuum energy is extracted.

"We've developed several circuit versions which can find application. In the



later experiment with an input power of 700 watts, that extracted by the generator loads resistance was three kilowatts, or nearly five times more.

"This is by far not the limit: with more powerful plants and the corresponding calculations, megawatts of free electricity can be produced from a minimal power source."

SGD Plasmatron Energy Applications

Yuri Galkin looks at the future of their discovery: "Its applications are wide-ranging; for example, engines based on the self-generating-discharge plasmatron. Until now, all attempts to use plasmatrons as engines failed, because strong electron and ion bombardments rapidly burnt out the electrodes.

"Self-generating discharge leaves them intact, and such engines can be used in aircraft, trains and autos. It would be logical to create a new environmentally-wise power industry. Portable hydros, wind-power plants and solar batteries boosted by self-generating discharge could become an enormous source of electricity. With time, they could edge out the costly and hazardous fuel-firing and hydraulic [hydro-electric?] facilities.

"Already now we can build a plant which would supply electricity for a township or factory. A vacuum power station comparable to giant facilities could be designed today. Our discovery can revolutionise cosmonautics."

Laboratory experiments have proved the possibility of using the kinetic effect of

self-generating discharge for accelerating bodies in space. Galkin has calculated the parameters of a self-generating-discharge plasmatron that could serve as the propulsion engine of the future, replacing the present unwieldy rocket engines. Powered by a minor 10-volt source, it could deliver power enough for the take-off of a large spaceship. Tapping the ambient space vacuum, it could fly eternally.

New Wave-Radiations Discovered

"We didn't think of only industrial applications," Chernetski recalls. "Self-generating discharge turned out to produce wave radiation which was hitherto unknown, but evidently existent at all times. Like sound waves, its waves have a longitudinal electric field component and a high penetrability through conductive mediums, including metals. It turned out that these single waves, 'awakening' the hidden vacuum energy, can alter substance structure.

"The experiment, staged at the Burdenko Institute of Neurosurgery in Moscow several years ago, showed that directional SGD radiation accelerated nuclear beta-decomposition by five-to-six per cent. This is only one example.

"We supposed that, like SGD-generator radiation, longitudinal electric-field component waves could also be produced by living beings—man, in particular.

"Comparative experiments were staged to prove the impact on men with extrasensory perception and of our device on different objects. In both cases, parallel impact on the high-stability quartz generator made

its frequency 'drift' by several orders of magnitude. The filament resistance of the incandescent lamp decreased considerably.

"Probably we are on the road to explaining such mysterious things as extrasensory perception, telekinesis and bioenergy."

A New Understanding of the Ether

The experimentally verified concept of Chernetski is claimed to be a theoretical breakthrough in the basic quantum-physics idea of the energy structure of the universe. It is generally recognised among physicists that all elementary particle interactions, and hence all existing phenomena, occur with the help of virtual-particle exchange. How does it come about?

"Full annihilation of virtual pairs cannot take place in the event of partial energy extraction in self-generating discharge, because a 'certain' virtual dipole must emerge: two separate charges with a common negative energy. This means that, together with energy extraction, vacuum structuring and ordering takes place.

"Actually, our concept is a return to the idea of the universal ether at an entirely new level," Chernetski adds. "We say that the ordered dipole vacuum, or ether, is an all-penetrating energy medium in which processes occur which are related to virtual dipoles and subject to the uncertainty principle of modern physics."

As Chernetski asks, if vacuum structuring is a constant process, isn't this an opportunity to state the law of conservation of entropy in the universe in opposition to the idea of its steadfast decrease?

What if this work helps to clear up the nature of gravitation, which is as dim now as it was in the times of Newton?

What this concept of the vacuum shows is the road to the long-awaited explanation of the grand unification theory.

"As an experimental physicist, I won't say our theory is 100 per cent correct," Chernetski declares. "It's much more an opportunity now to have indisputable experimental data to prove the opportunity of creating a basically new power industry."

Only a rapid switch to new energy can save human civilisation from ecological catastrophe. The research program must be developed immediately and a centre set up to coordinate cooperation between world scientists. Natural and unlimited vacuum energy is at our doorstep.

(Source: Posted on 21 December 1995 on KeelyNet, <http://www.keelynet.com>)

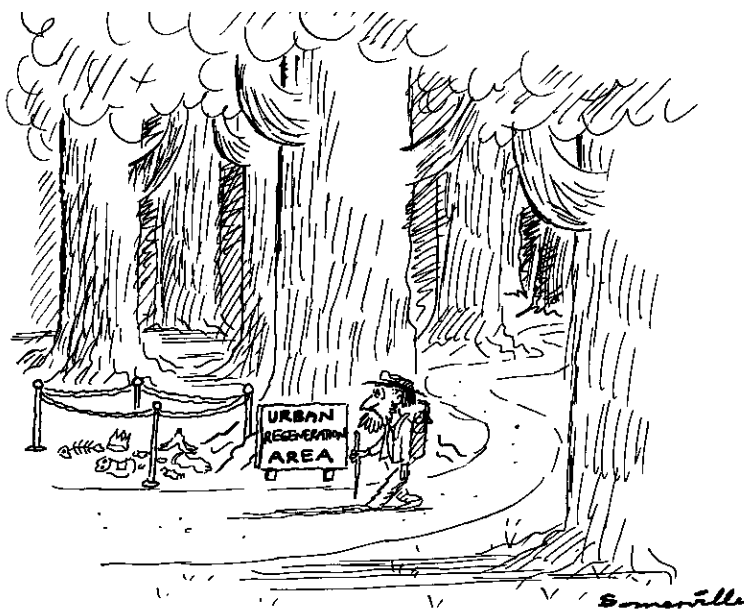

BRIGHT SKIES

Top-Secret Weapons Testing?

***Were Tesla-style
EM weapons used
in the Kobe
earthquake, the
Oklahoma City
bombing and the
downing of TWA
Flight 800, in a
secret war
between
unidentified
factions?***

Part 5

by Harry Mason, B.Sc., M.Sc.

©1997 All Rights Reserved

1313 Armstrong Road
Jarrahdale WA 6203, Australia
Phone: +61 (0)8 9525 5999
Fax: +61 (0)8 9525 5944
E-mail: orbitx@ois.com.au

EARTHQUAKE-INDUCING ELECTROMAGNETIC WEAPONS USED AT KOBE?

On 17 January 1995, the Japanese city of Kobe was struck by a massive earthquake that devastated much of the city, killing over 5,500 people and injuring many thousands more. Shoko Asahara, the leader of the Japanese Aum Supreme Truth (*Aum Shinrikyo*) sect, had surprisingly predicted, in a Tokyo radio broadcast on 8 January 1995, that a major quake would soon occur at Kobe. Asahara went even further and stated that this quake would be initiated by a "foreign power" utilising an electromagnetic (EM) weapons system.

Aum's Science Minister Hideo Murai later stated at the Foreign Press Correspondents' Club in Tokyo on 7 April 1995 that, "There is a possibility that the great Hanshin [Kobe] earthquake was activated by electromagnetic power or some device that exerts energy into the ground."

Although Asahara would undoubtedly have preferred his great predictive powers to be thought of as due to a highly developed and superior spiritual ability to examine the future time-track (thus attracting more gullible followers after this quake event), it is far more likely that he was fed warning intelligence re Kobe by Aum's Science Minister Murai, and/or Japanese Intelligence operatives who themselves were forewarned by Russian KGB officials.

In his pre-Aum days, Hideo Murai had worked on highly advanced microwave and gamma/cosmic-ray physics applications for cold moulding of steel at the Kobe Steel laboratories. This laboratory complex was located at the near-exact epicentre of the great Kobe earthquake. Japanese investigative journalists believe that this Kobe laboratory was one of several research facilities (located at Osaka, Tsukuba and Tokyo universities) engaged in top-secret research and development of EM weapons technology—under the cover of Kobe Steel industrial research and/or environmental "desert-greening" studies.

The Aum's deputy leader, Kiyohide Hayakawa, in his pre-Aum days studied at Osaka University in the Landscape Engineering section of the Environmental Engineering department. His thesis is highly confidential and not available to the public, but allegedly contains only landscape engineering studies.

For several days prior to the great Kobe earthquake there were reports of glowing orange-red and pink lights and spherical forms hovering over and along the Kobe fault line. Such Earth stress lights have been observed over major quakes in many parts of the globe since the 19th century, but the number and intensity of those that developed in the January 1995 pre-Kobe quake days appear to be highly anomalous.

The existence of geophysical weapons capable of creating or triggering earthquakes in highly stressed crustal regions has been discussed privately by geophysicists for a decade or more. Rumours have abounded over certain huge earthquakes of the 1970s and 1980s in the Central Asian republics of the former USSR. Some writers have suggested that these were caused by Israeli, French or American EM weapons systems used in retaliation for Soviet EM weapon strikes on the West. US scientist Tom Bearden contends that the Soviets brought into service an intercontinental-range Tesla EM weapon in 1963 during the Khrushchev era.

The evidence that Kobe was not a natural earthquake is slender and is based primarily upon Asahara's prediction that was later proved so horrifyingly correct. However, one cannot be certain about actual cause, and quite possibly I am totally incorrect in suggesting this event could have been caused by a sentiently controlled and directed EM energy weapon. There would appear to be some supporting evidence of an indirect nature involving political considerations and other more recent events. However, taking into consider-

ation the entire Kobe and Aum Tokyo scenarios together with the earlier, possibly Aum-related, fireball-explosion-earthquake events of 28 May 1993 at Banjawarn, Western Australia, one is left with a very strong impression of a serious fire underlying the visible "dark plume of smoke" that rose over Kobe.

But what motive could there possibly be for such a major city-busting weapon strike? Why choose an exotic EM weapon system?

It is quite possible that the EM strike was directed at the secret Kobe Steel EM weapons research laboratory and that the motive was in part to destroy this facility and cause such a resounding blow to the civilian population, similar in scale to the nuclear bombings of Hiroshima and Nagasaki, that the Japanese oligarchic powers behind the scenes would think long and hard before attempting to continue their EM weapons project.

If the USA (or a covert international power group based therein) were the belligerent party that struck down Kobe, then the motive would most likely have included a 'big stick' warning to the Japanese powers to do what they were told with regard to the New World (economic) Order, or face the consequences.

It would appear from subsequent events that the Japanese oligarchy did not grovel under this attack but in fact, after some further provocation, went on the offensive with its own (or a friend's) EM weapon system.

FACTIONS AT WAR?

During 1995 and 1996 the following major events were literally blasted onto the world stage:

- 1) 17 January 1995: The great Kobe "earthquake";
- 2) 20 March 1995: Tokyo subway gas attack;
- 3) 17 April 1995: Oklahoma City "terrorist bombing";
- 4) 1 May 1995: Perth "fireball-explosion";
- 5) 17 July 1996: Destruction of TWA Flight 800 off New York City and Long Island.

With the exception of the Tokyo subway gas attack, each of the above events can be proven to contain evidence for the apparent involvement of highly advanced exotic EM weapons systems. The Tokyo subway gas attack appeared to involve the Japanese Aum Supreme Truth sect and possibly several other players previously 'fingered' in the EM weapons game. For some reason the 17th day of a number of event months appears to be significant; this may reflect payback timing based on the first major event on 17 January 1995.

Taken as a whole, these events appear to represent an escalating exchange of fire between opposing (but unidentified) factions. The nature of this ongoing war and the identities of the opponents and their leaders appear to have been very deliberately kept secret from the planetary population, whilst elaborate webs of lies have been erected in the world press and Japanese and US courts to nominate patsies as the perpetrators of these shocking events.

The development of apparently magical EM weapons capable of initiating earthquakes or nuclear-force-level explosions over or within targets located at a great intercontinental distance by transmission of scalar or Tesla EM ray-waves from two or three transmitter sites—or EM weapons able to strike target sites from an orbiting satellite, spacecraft or aircraft—or ground-based EM beam-pulse weapons capable of taking out orbital or airborne tar-

gets, has for the first time in our planetary history allowed the use of 'deniable' massive-force weapons in terrorist acts directed against the general population.

These EM weapons effects are "deniable" in that they can be blamed upon natural earthquakes, meteor air-burst explosions or bolide ground-impacts, or can be set up as terrorist-bomb, ground-to-air missile or even alien UFO scenarios. The ability to cause apparently magical-force events implies an enormous advantage to certain individual power groups who appear to have stolen these weapons (from the states that originally developed them) to use solely for their own advantage.

Such weapons in the hands of secret power groups who are willing to use them without mercy against the innocent citizens of planet Earth, represents a horrifying future prospect in the power struggles of this planet. Defence against such weapons and the curs who control them must now be our primary objective. The nuclear terror has been replaced by something far worse: a usable, high-energy weapon.

BEHIND THE TOKYO SUBWAY GAS ATTACK

The Tokyo subway gas attack on 20 March 1995 killed 11 people and injured thousands. The Aum Supreme Truth sect was soon implicated by the Tokyo Police and the world Press.

The Aum was reported as initiating the gas attack as a prelude to a revolutionary "right-wing" takeover of Japan. Aum members were shown on film by the BBC being trained and armed by the Russians. Allegedly the Aum smuggled thousands of automatic rifles and other weapons into Japan from Russia. Apparently the Aum

intended to use Russian helicopters and *Spetsnaz* troops landed on the coast as aids to allow Aum forces to take control of Japanese Government ministries during a series of major diversionary terrorist nerve-gas attacks on key population and government centres across Japan. The Tokyo subway attack was allegedly a preliminary operational test prior to the full-scale action.

In Australia, ABC TV soon ran a prime-time news story with video showing a shed full of large chemical drums (found at Banjawarn by the new post-Aum owners) and trenches full of hundreds of dead sheep. The report also discussed Federal Police reports concerning sarin-gas-derivative chemicals found in the dead sheep, and interviews with the Aum's Australian sheep station manager. All of this was supposed to demonstrate that the Aum purchased Banjawarn station to carry out tests with home-made sarin nerve gas on sheep, as a precursor field trial to the Tokyo subway gas attack.

Problems soon surfaced with regard to this official Australian press scenario. The present owners of Banjawarn reported to this author that the ABC TV story was "a pack of lies", for the shed of chemicals shown on the 7.00 pm news was not on Banjawarn station; in fact, they had never seen it, and did not know where this video had come from. They insisted that they had only reported finding two relatively small bottles marked "HCl" (hydrochloric acid) in the old station building, which was previously used by the Aum sect in September 1993 as a mining field-laboratory.

The ABC news footage showing hundreds of dead sheep was actually stock video recorded the previous year when sheep were being shot on farms near Esperance, WA, due to extremely low

Taken as a whole, these events appear to represent an escalating exchange of fire between opposing (but unidentified) factions.

market prices. Only a few tens of dead sheep were found by police on Banjawarn, and these had been put down by hammerblows to the head by the Aum's *real* manager—appointed by the WA Pastoral Board because the Aum's novice manager had failed to tend the station's windmills, thus causing a shortage of water for the flocks, which resulted in many severely dehydrated sheep having to be put down.

In Japan, European chemical and nerve-gas experts who examined the Aum's chemical complex laughed at the notion that sarin or any other nerve gas had been made there, pointing out that the equipment and facilities would have leaked like a sieve, killing the operators and local villagers. They did find plenty of residual evidence in the plant that demonstrated that large quantities of designer drugs such as ecstasy had been manufactured there, right up to the time of the Tokyo subway gas attack.

Small samples of sarin and other nerve gases as well as other lethal gas and chemical types were found in the Aum complex, along with a few automatic rifle kits of Russian origin and equipment for duplicating further arms. However, Aum members were apparently deliberately warned about a week in advance that a police raid was coming—thus allowing them to remove any other stocks of arms, gases and drugs in advance.

It appears that deputy leader Hayakawa used the sect as cover for a range of foreign weapons purchases and weapons-related research—apparently for the "right-wing" oligarchic power behind the Japanese Government. It is quite obvious that at least parts of the Aum organisation were not staffed with 'good guys' and that they were involved with some quite crazy and antisocial activities such as the manufacture of massive quantities of drugs.

Japanese investigative journalists believe that the drugs were being distributed worldwide by the Yakuza, possibly through a rogue CIA operation. Thus, in time-honoured secret-service fashion, a "right-wing" Japanese oligarchic intelligence operation was being funded by illicit drugs.

These same Japanese journalists (see their web site, www.pelago.com) have suggested that the Aum sect was a cover for Japanese Intelligence operations involving covert re-arming of the Japan Self-Defense Forces with new Russian weapons systems. Recent Japanese Defense Agency press releases tend to support this view by revealing large, new purchases by Japan of modern frontline Russian jet fighters and bombers, as well as joint communications exercises between the two countries' defence forces. There is plenty of evidence concerning the Aum's activities in Russia, such as training with Russian troops and managing the joint Japan-Russia University in Moscow—a cover for a Russian-Japanese redevelopment of the first-generation Russian EM weapons systems mated to Japanese computer power.

As early as mid-1993, in his visa applications to enter Australia, Asahara complained of gas and laser attacks on his person and against Aum facilities. He continued to complain of such attacks in further correspondence with Australian Immigration in mid-1994. If taken at face value, this data and much else of the press web re the Aum suggest that the Aum (and hence their backers?) has been the victim of a knockout blow delivered by a very influential foreign secret service. The Aum was set up as the perpetrator of the Tokyo subway gas attack—the patsy, if you like.

It may be highly significant that over 50 per cent of the Japanese LDP Cabinet allegedly fled covertly to North Korea for

one week's negotiations, the day after the gas attack. The Aum Science Minister Hideo Murai was murdered by a North Korean hitman's knife soon after the Tokyo subway gas attack. Someone was very afraid that he was going to talk. Apparently Murai's last words in the ambulance were the equivalent of "The Jews got me!", although other interpretations of his final mumblings have also been advanced.

Hayakawa left his early "landscape engineering" studies and joined the Moonies, whereupon he was equipped with the deeds of several Tokyo buildings and vast sums of cash so as to buy his way to the top of the Aum sect. The Reverend Moon was a close friend of the North Korean "Great Leader". Reportedly the Moonies still have exceptional ties to North Korea and, more recently, to ex-US President George Bush, involving business ventures in South America.

Several previously reliable Japanese sources believe that the CIA planned and executed the Tokyo subway gas attack to destabilise the LDP government and/or force it to co-operate with US policy requirements. The exact nature of their evidence is unknown to me, but similar claims have been made by Debra von

Trapp, an ex-NSA/CIA agent involved with bugging the Clinton White House for a George Bush-controlled faction of the CIA on behalf of certain Japanese industrial companies during key USA/Japan trade talks.

The strange ABC TV deception of its viewers, by implanting the Aum = sarin nerve gas = Banjawarn station testing = Tokyo subway gas attack imagery across Australia, suggests an intelligence action in

support of United States interests.

OKLAHOMA CITY "BOMBING"

On 17 April 1995, at a few minutes after 9.00 am, Oklahoma City was blasted by the "terrorist bombing" of the Alfred P. Murrah Federal Building. One hundred and sixty eight men, women and children were killed, and hundreds more were maimed or injured in this callous attack. The building was nearly totally destroyed by the explosion, whilst severe damage was inflicted on adjacent buildings, petering out at about a one-mile radius from ground zero.

This event was soon blamed upon a "right-wing militia group" composed of ex-Gulf War veterans utilising an ANFO bomb composed of from two to five tonnes of ammonium nitrate and Diesel fuel-oil set up in a hire truck parked in front of the target building. A robotic Timothy McVeigh was recently convicted of the OKC "bombing", and his alleged accomplice Terry Nichols awaits his trial (which is about to commence as this article goes to press).

On the day of the event, I, like many others, watched the CNN TV feed of the Oklahoma scene. Intriguingly, there were early reports of missiles being seen coming down vertically into the building, but these reports never resurfaced. A survivor with blood over his face was interviewed about one hour into the rescue effort. He described how his life had been saved in his previous domicile in California. When the Murrah Building began to shake violently he recognised an earthquake, just like those he had experienced in California, so he dived under his fifth-floor desk. Some five-to-ten seconds later, a huge explosion demol-

Reportedly the Moonies still have exceptional ties to North Korea and, more recently, to ex-US President George Bush, involving business ventures in South America.

ished the building around him, but the desk saved his life.

Then came reports that more bombs had been found, and a utility truck with a small armoured bomb box in its tray was shown, whilst the FBI's radio delivered a conversation alleging large drums of mercury fulminate explosive had been found attached to building support pillars next to the lift shaft.

I became agitated, since I had never heard of earthquake-type effects hitting a building *before* a bomb went off, and I knew mercury fulminate to be an extremely unstable explosive and very unlikely to have survived a major explosion. Also, the size of explosive drum reported then and later photographed would have been far too large to fit in the armoured bomb box that reportedly drove away with these dangerous prizes.

Explosives experts in Australia, the UK and USA (e.g., the General Partin report) began to question the nature of the damage at OKC. The gist of their theses is that low-velocity explosives like ANFO cannot have demolished so many support pillars in the strange pattern seen at OKC, since the blast pressure falls off according to the inverse cube distance law—yet some near-bomb pillars were still standing, whilst some further away from the bomb were demolished by the blast. Their reports generally invoke a need for very-high-velocity explosives and individual charges attached to certain pillars inside the building—requiring hours of work to fit out. Personal friends with experience in mining explosives and Belfast IRA ANFO terrorist-bomb damage have confirmed these points to me and have noted that the crater that developed at OKC does not fit with the truck bomb explanation or the truck's alleged parking lot position.

Another possible weapon candidate soon surfaced: the "A-Neutronic" bomb. In this scenario, a mad criminal scientist (the infamous Michael Riconosciuto, currently serving time in a US prison), developed for the US Government a new super-weapon that involved blowing a cloud of chemicals into the air, charging the cloud with a large excess of electrostatic energy by means of a small rocket-carried "wire", and then detonating the resultant "fuel-air" mix to create a small nuclear-type explosion.

I began to collect eyewitness reports and evidence from official source publications and Internet sites relating to the OKC event. Then, in late 1996, I visited Oklahoma City and with the help of local author David Hoffman examined the "bombing" site and interviewed local witnesses. The outpourings of grief and anguish present, with messages and wreaths of the victims' relatives and friends on the targeted building site's protective fences, made me resolve to give this event my very best analysis to try to deduce the true nature of this explosive event and thereby help indicate the *real* culprits.

Seismic evidence recorded by local seismometers demonstrated a double-pronged explosive energy event with two nearly identical three-to-five-second, low-amplitude, multiple wave trains separated by a null field, occurring over a nine-second interval. USGS geophysicists argued that these two wave-packets were due to an initial ground "surface" wave arriving before a secondary wave that had travelled via deeper reflecting Earth layers, i.e., via the local basement. Other geophysicists argued that there were two wave-packets, representing the explosion followed by the building debris impacting with the ground.

These hypotheses were blown apart by the US Government's explosive demolition action on the Alfred P. Murrah Building remains, which failed completely to demonstrate a two-pronged seismic response that was in any way similar to the original event recordings. The original and best seismic recordings have been confiscated by the FBI, along with many other items of evidence such as the City video-surveillance tapes. Hardly surprisingly, none of this evidence surfaced in the McVeigh trial.

Along with the evidence of seismic action shaking the building some five-to-ten seconds *prior* to any explosion or blast wave hitting the building, there were several other mysterious *pre-explosion* events. A policeman working at his computer noticed electrical sparks and streamers in the wiring under the table several seconds *before* the explosion brought the building down around him. A woman on an upper floor noted a strong ionising electrical sensation and hot air-flow entering the windows several seconds *prior* to the explosion which blew the same windows in on her. The lights in the building went out some five seconds *before*

the explosion. A dictation tape recording made across the street from the "bombed" building recorded a loud "click" a few seconds *before* it recorded the sound of a huge explosion. This "click" was probably a local electromagnetic wave spike of considerable intensity.

An eyewitness located in a car a couple of hundred metres from ground zero observed a silver-white light flash or beam coming out of the top of the building, followed by a large blue-white electrical arcing flash or beam, followed by an orange-

red light flash or beam that shot out from the top of the building. These electrical and light effects took some five seconds and *preceded* the actual explosion. (Reports of missiles may have been mistaken identification of these pre-explosion energy beams.) They were followed immediately by two explosive shock waves, one trailing on the other, that propagated out and away from the base of the building. These waves lifted the ground and buildings violently upwards. The witness called this the "lid effect".

Several cars located on the above-ground carpark had electronic ignition computers completely burnt out by the event. Two cars had factory-fitted digital magnetic compasses that were later found to have been thrown out by 180° and 45° respectively. Many nearby office computers went down with burnt-out circuit-boards. These facts point strongly to a major EM pulse having struck the area associated with the explosion.

The local area damage from the OKC event was huge. I cannot emphasise enough how devastated this area was. I was quite amazed when I visited the site. Entire blocks of damaged office buildings had been knocked down due to their shattered state, some nearly a mile away from ground zero. Large open spaces were surrounded by boarded-up buildings with no windows, no roofs, and intensely shattered internal concrete beams and supporting pillars. I saw the intense damage inside the nearby newspaper building where internal dividing walls had been smashed asunder and horizontal three-foot-square reinforced concrete beams sagged down everywhere. This building had been built to very high 1930s standards to withstand tornados, yet it was wrecked. Many buildings had entire windowsills forced back in with their front brick walls sagging inwards. Nearer to ground zero, large, one-foot-wide, floor-and-wall reinforcing steel H-

It is my contention that the OKC event was the result of a double-pronged EM weapon strike that caused the Earth's dielectric field to erupt up through the building.

girders were twisted like spaghetti into grotesque shapes amidst the ruins of entire floors blown away to dust and rubble.

I showed a suite of local damage photos to retired SAS trooper friends, with experience in IRA ANFO bomb damage. They were as amazed as I was, and stated categorically that this was no ANFO damage. They said it would not have mattered how large an ANFO bomb had been detonated, it could not have caused the damage seen in the photos and/or described in the US literature.

Funnily, the FBI released film of ANFO car-bomb test explosions that show significant fireball or fiery effects from such explosives. Yet no witnesses have described any fiery explosion or flames—just strange, pre-explosion light flashes or beams followed by pure energy waves, with very high plasma-type heat effects noted on nearby car paint.

It is my contention that the OKC event was the result of a double-pronged EM weapon strike that caused the Earth's dielectric field to erupt up through the building. The building shook first because of harmonic reaction to the first EM wave packet which also blew the building's electrical supply and created the various computer, digital compass and ionising hot-air effects. Having rocked the building sufficiently, the EM weapon mode was advanced in a second strike to initiate atomic-bond rupture and literally blow the building material apart.

No conventional or nuclear explosive, including a so-called "A-Neutronic" bomb, can cause seismic shaking and electrical light-energy effects in a structure, seconds *before* the explosion blast-wave hits.

Oblique aerial photos of the Murrah Building show two nearly vertical, tubelike damage forms running through the building. These represent slightly displaced near-vertical but divergent beam-pulse orientations, suggesting an orbital platform was involved in the action.

Any bomb or militia-terrorist character to this event was set in train by those who hit the building, to ensure that the true nature of the weapon system and its technology was hidden from public and possibly other US Government personnel.

This implies that a faction from within the US Government was responsible. Either that, or the US Government was warned well in advance that this particular building would be hit that day by an advanced weapon over which there was no defence—so it quickly found a patsy and built up a cover story.

"Need-to-know" secrecy policy suggests that there then entered a cock-up of horrific dimensions. Lower-level personnel had been searching for a bomb earlier that morning, having been told that the building was targeted for bombing by terrorists, but, in failing to find it, they then did not proceed to evacuate the building. Higher government levels, having decided to hide the horrible truth from even their own operatives, had to have a plausible McVeigh militia-type event. The Alcohol, Tobacco and Firearms personnel were better served, as were the Judges in the adjacent court house: they were all warned to stay away that day.

Secret Service personnel engaged in anti-drug operations were in their offices which lay in the centre of the damage and were wiped out by this OKC event. Interestingly, similar terrorist-bombing events in the past were apparently aimed at the same anti-drug Secret Service in both the downing of the Lockerbie Pan Am jumbo and the "bombing" of the New York World Trade

Center. Indeed, it is possible that this entire series of events is being fought over a drugs empire.

PERTH'S EARLY MORNING WAKE-UP CALL

In the early hours of 1 May 1995, a major fireball flew in a north-northeasterly direction towards Perth, WA, and detonated above the eastern side of the city at approximately 2.00 am in a huge explosion. Limited Australian press coverage of this event defined it as a meteor fireball. Unfortunately, too many such fireballs fly around our night skies, exhibiting exotic flight behaviour and a preference for the first of May each year.

This Perth event has been described in more detail in Part 1 of this "Bright Skies" series (see NEXUS 4/03, April-May 1997), where I present evidence for the non-natural origin of this event and suggest that it represents an EM weapons incident of probably Russian origin, or possibly off-planet alien origin.

The megatonne-force level of this explosion woke up over half a million people and demonstrated that Perth could have been obliterated at the flick of a switch.

This was the message in the wake-up call made that early morning to the people of Perth.

I strongly suspect it was pointing out that WA hosts a huge US-controlled EM weapons system at Exmouth in the northwestern part of WA, and that we should *wake up* and bring order to our own house—or face the consequences.

The trajectory of this fireball suggests an origin in Enderby Land, Antarctica, where a number of Japanese and Russian bases are located.

The fireball flew on towards the Kamchatka Peninsula where a huge Russian (former Soviet Union) EM weapons complex/transmitter (Tx) site lies.

The seismograph record of this Perth meteor event is surprisingly similar to one of the two low-order wave-packet arrivals seen on the record of the OKC "bomb" events.

On the premise that such a fireball represents no mass object but is purely a concentrated slug of 'infolded' EM energy created by a Russian-type Tesla weapon system, I contend that this incident fits well with the other exotic events of 1995 and represents yet another stage in an escalating oligarchic war for control of our planet.

Some evidence in this study points strongly at a mainly Earth-based series of actions involving those who live by the profits of drugs, fighting against other oligarchic power-mad men—with both sides utilising very technologically advanced EM weapons systems. However, some evidence points to a battle between secret Earth-based power groups and off-planet aliens—possibly the little Greys or the greenish Reptilians (see Part 4, NEXUS 4/06). Perhaps we are involved in both scenarios, with two Earth-based oligarchic factions with separate off-planet allies fighting with horrific new weapons for control of planet Earth.

Rumours abound about all of these scenarios—but then again, it is quite possible that none is correct and we are just dealing with strange, exotic, natural events that have been mistakenly identified.

Even so, these events have been, and continue to be, extremely dangerous to human life; thus, whatever is going on requires immediate attention by the people of this planet—as the next incident involving the fateful TWA Flight 800 amply demonstrates.

The megatonne-force level of this explosion woke up over half a million people and demonstrated that Perth could have been obliterated at the flick of a switch.

THE DOWNING OF TWA FLIGHT 800

TWA Flight 800 was destroyed on the evening of 17 July 1996, and, with her, some 230 men, women and children perished.

I had been researching strange orange-red fireballs and other exotic light-energy beams observed around Australia when I was surprised by reports coming out of the USA about events surrounding the downing of TWA 800. I fly quite a lot on jumbo jets, and the thought of a bunch of nutters killing off hundreds of ordinary, innocent people made (and makes) my blood boil.

Reports soon started coming in, one from a New York Air National Guard helicopter pilot who, on patrol that Wednesday night, was an eyewitness to the explosion of TWA Flight 800.

"I know the strike of a missile. What I saw didn't look at all like a missile," said Commander Fritz Meyer of the 106th Rescue Wing of the New York Air National Guard. "Our three-man crew saw the same thing: a flash of red-orange light, characteristic of a shooting star," he said. "Then we saw a small explosion followed by a large explosion, and a ball of fire fell into the sea."

I telephoned the Pentagon in Washington and was put through to the pilot's air base, but after leaving messages I got no reply—

until about a week later when I reached the base control-tower. By accident, this man was in the tower, having been grounded due to the very same news item and a very upset FBI and New York Mayor who had ordered him gagged. I spoke with this pilot for a few minutes and felt that he was an honest man and, like all military pilots, a damn good observer who was very perplexed at what he had seen that night. He reiterated that he knew missiles from his Vietnam tours and it definitely wasn't one of those. He said he really would like to know what it was and would love to chat with me further, but I had better get the okay for us to talk from the public relations officer at his base.

A fax exchange later, I was reading that FBI investigators wanted *no one* to talk to this man until they had determined the cause of the "crash". He and I are still waiting for that chat.

Over the next few months, several airline pilots saw similar orange-red and green-blue mini-fireballs with tails flying at jumbo-jet height through this area. A TWA pilot returned to Kennedy Airport rather than proceed, after seeing one such meteor-like object fly past his wingtip. In all, about 10 separate reports came in of strange fireballs or meteors in the New York and Long Island air space vicinity.

Meanwhile, allegedly after demands from the French Government which lost several Secret Service men on TWA Flight 800, the US authorities assembled a team of divers who recovered the wreckage from the sea for a crash investigation. The flight recorder was recovered but it was electrically dead due to burnt-out circuits and gave no clues to the events of that night. I had earlier predicted in e-mails to the FBI the likelihood of just such a fact by analogy with evidence from Australia that our orange-red lights and fireballs were EM field effects, possibly due to the testing of scalar EM weapon systems. The FBI did not reply.

Theories began to execute a "do-loop" in the world's press. These revolved around a meteorite impact, a terrorist bomb, a terrorist missile, and, later, a US Navy missile or drone impact, a

bird impact, a mechanical failure of some kind, and an explosion in the near-empty central fuel tank. Recently the crash investigation team has come out with evidence for an electrical overvoltage spark in a valve located within the central fuel tank, and has suggested that this was the cause of the explosion and that Boeing should redesign this part.

Obviously their findings should also include considerations on what caused the overvoltage jump; for instance, was it an EM weapon pulse or an electrostatically charged meteor? Trouble is, meteors do not keep returning to the same piece of the Earth every few days—as has been recent experience around New York.

Interestingly, there were many UFO reports from Long Island over the preceding two months, and a local UFO researcher was arrested under cloudy circumstances just five weeks before the TWA 800 event.

In late 1996 a leading British psychic, who often works with Scotland Yard and MI5, was approached by the CIA and asked to remote-view the TWA 800 incident. She reported seeing two beams flash down from high altitude; where they intersected they created a third orange-red beam which shot out, hitting the jumbo

jet and causing the secondary major explosion. This was fascinating stuff, since her description was almost the verbatim equivalent of the actual eyewitness evidence from the 1987 DC-8 crash near Gander in Newfoundland, northeast Canada, that killed hundreds of US Army personnel. She did not know of this event, and had seen only British news about the TWA 800 explosion—and nothing about beams.

However, the overall evidence pattern here links the destruction of TWA 800 to an EM-type event that strongly resembles certain of the Australian fireball-event types. We

are left with yet another strong impression that this event—on the 17th day of the month, again—involves Secret Service agents (French ones this time) and advanced EM weaponry that has been responsible for the death of hundreds of innocent people.

Then again, as in many other incidents around October 1997 in New Mexico, Queensland and New South Wales, there are elements of the picture that suggest an ongoing war with alien, off-planet UFOs. Perhaps a UFO really did knock down TWA Flight 800, and Triffid meteor showers or some modern derivatives have made us all blind to the new reality on our patch. Or maybe some strange, EM-style natural event, such as an electrostatically charged bolide, caused the demise of this plane and its passengers.

I, for one, think it's high time we found out the truth. Our lives, and quite possibly the future of our race, could depend upon it.

Note: Anyone wishing to report exotic fireballs/light-emission events, or knowing about EM weapons systems technology/testing in Australia or elsewhere, may phone the author on +61 (0)8 9525 5999 (after 10.00 am WA time = GMT + 8 hours), fax on +61 (0)8 9525 5944, or e-mail orbitx@ois.com.au.

About the Author:

Harry Mason, BSc, MSc, is a UK-born geologist/geophysicist, resident in Perth, Western Australia. His 30-year international career has given him extensive field experience in mineral resource exploration, including seismic and EM studies. He (usually) specialises in the geology and resource exploration of Western Australia's eastern Goldfields.

Interestingly, there were many UFO reports from Long Island over the preceding two months, and a local UFO researcher was arrested under cloudy circumstances just five weeks before the TWA 800 event.



THE CRYSTAL SKULL'S MESSAGES FOR MANKIND

Just like the ancient legend, [Frank] Dorland's theory suggested that the crystal skull may really be able to provide us with important information from the past. The Maya today apparently also believe this to be the case. Even the scientists at Hewlett-Packard recognised that natural quartz crystal has information storage capacities and so were not entirely closed to the possibility that the crystal skull might have information programmed into it. But what sort of information might that be, and how might we be able to access it?

When Chris and I were visiting Anna Mitchell-Hedges [in Canada], we had already met a woman [Carole Wilson] who said she knew how to access the information inside the skull. Like Frank Dorland, she claimed conventional scientists had failed because they were using the wrong approach. She said the secrets of the skull could only be uncovered using "the technology of the mind". We were somewhat sceptical, but curious nonetheless. If this were really possible, what might we find? Perhaps secret knowledge that had been buried in this crystal storehouse for thousands of years...

When Carole arrived, she turned out to be a quiet, well-dressed woman in her

fifties with a very professional manner. I was somewhat surprised to find that she was accompanied by the former head of the Toronto Police homicide department [John Gordon Wilson, her husband]. It soon transpired that...the Police had used Carole's services many a time and had managed successfully to solve a whole string of murder and missing persons cases...

Carole now works closely with police forces throughout the United States, Canada and Britain...

The plan was that Carole was going to channel the 'entity' of the crystal skull and we would be able to ask it questions. Carole requested that any questions we asked were very specific. She explained that the skull did behave a bit like a computer in that you had to give it very specific instructions and to be very clear about what you were asking, otherwise you might not get a very helpful answer. For example, someone once before had asked the skull what a skull was and had received the answer that it was "a bony structure"! She also warned that sometimes the skull anticipated the questions in advance and told us not to be put off by this.

Anna then placed the crystal skull on a small turntable so that Carole would be able to touch it from all angles and manipulate it as she wished during the channelling session. Carole sat down and the crystal

skull was placed directly in front of her, where it glimmered softly in the lamplight.

Carole closed her eyes. She began altering her style of breathing and used a low hum to ease herself into the appropriate mental state. The whole room began to take on a somewhat eerie atmosphere of the kind you might expect during a séance, as Carole's gestures and posture changed. Suddenly tense, she began to emit an incredibly high-pitched humming sound. Before I was even able to ask the first question she began speaking in a strange, somewhat staccato voice, with a very stilted use of the English language. I remember being struck by the fact that you could actually hear this new voice echoing strangely around the room.

You seek to know the origins of this receptacle which you call "the crystal skull"... I tell you that it was made many, many thousands of years ago by beings of a higher intelligence... It was formed by a civilisation before those you call "the Maya". Our level of civilisation was, as you say, "at that time" far in advance of that which you now have by many factors...

The speech was interrupted by high-pitched humming, and then continued:

This receptacle contains the mind of many and the minds of one... It was not made using what you call the "physical". It was moulded into its present form by

THE TWILIGHT ZONE

thought. The thoughts and knowledge are crystallised into this receptacle...this receptacle is thought process crystallised...thus the information was crystallised into this receptacle...

We have put thought form into pure language within that which you call "the crystal skull"...

Much of the world that we created, we created with mind. Mind creates matter. You will understand this and crystal technology will be given to those who understand it in more detail...that crystal is a living substance and you can infuse mind with matter...

So it seemed that the crystal skull had been made by an advanced civilisation using thought. But it was all a little confusing, to say the least. I was about to ask why the crystal had been shaped into the form of a skull when the voice continued, in the same manner:

This receptacle is crystallised because you, within the third dimension, need to see, to hear and to touch... Its form makes it easier for mind to attach to mind, without what you call personality... But you respect the personality, the head, the enclosure of your brain...so this form of the receptacle has been guarded and guided for many an age... The Earth life of this receptacle is 17,000 years... It has been handed down from generation to generation, polished with sand and hair...and no harm will come to it.

So the reason the crystal had been made into the shape of a skull was so that it

would be respected and cared for over the years. I was about to ask if there were any other crystal skulls, as the legend had said, but once more the voice spoke before I was even able to open my mouth:

You are seeking information as to the other receptacles of mind... There will be other receptacles found...for there are many...for no one man and no one mind were given all knowledge... Each of the receptacles contains the information of where the others are...

We would give you one where we left markings upon the Earth [some have since suggested this may be the area of the Nazca lines of Peru, although there are obviously many other alternative possibilities]...and high in the mountains... There will be one of blue in the region you call "South America"... There will be another found when the lost civilisation that you call "Atlantis" rises to you...and we would urge you to explore the ocean bed...we would urge you to explore the discoveries in the area you call "Bimini"... But we will direct you...we will show you that which you call a "temple"... This was an area of communication between the Earth and other systems...

When all receptacles are placed together, you will be keepers of wondrous knowledge... Light and sound will be the key; when the right vibration is produced you will have the information you require... But the time is not yet... There are still some that have not yet been given form...and others which remain safely

under your ocean bed... But you shall not find them all, as you say "at this time"... It would be too dangerous for man to have this information...too early in his evolution... because mankind still seeks to better all the original destruction of our time.

I did not really understand all of this somewhat cryptic information, but I was curious as to why

the crystal skulls had been made in the first place. Yet again, the voice anticipated my question:

The receptacle has been given this form to encourage the mind of oneness and to reduce your desire for separation... Your mind seeks separation... We sought to leave you with the concept of oneness, but your mind seeks only separation. As you say, "As you seek, so shall ye find." And already the process of separation has begun. You have already begun the separation, but there will be more. You have a desire to separate that will lead to your own destruction... Separation causes annihilation and death. We can already feel the influence of this separation as violence... There is much violence occurring within your planet. Violence against men, violence against nature...violence against the Earth.

Again, I didn't really understand these rather cryptic remarks and I was more interested in whether the crystal skull could tell us anything about mankind's history. The answer came:

We understand that you come seeking in quest of the beginnings of man. We wish to tell you that your own origins were thought in form, and that you have to cast your eyes up and not down. There will be many discoveries pointing to this acknowledgement within the next 5, 10, 15 years... And the beginnings of what you call your civilisation are over 15,000 years before the acknowledgement of that which you call Atlantis. For there is also much evidence of our civilisation still beneath your oceans. Already there are discoveries near Bimini. But there will be many more discoveries over the next 5, 10, 15 years which will point you towards the right direction... There will be more discoveries in South America, in Australia and in Egypt. In that which you call your "deserts" you will find much knowledge. But you will find traces of our civilisation through most parts of your land masses and there is much beneath your seas, especially beneath the oceans which you call "the Atlantic" and "the Indian", and that which you call "the Dead Sea". There, closest to your Earth's surface, and soon to be discovered, are remnants of our civilisation... These discoveries will confuse and cause much disharmony, but they will be needed to reduce the mind of separation.

But many of these discoveries will not be permitted at this time. We can only permit

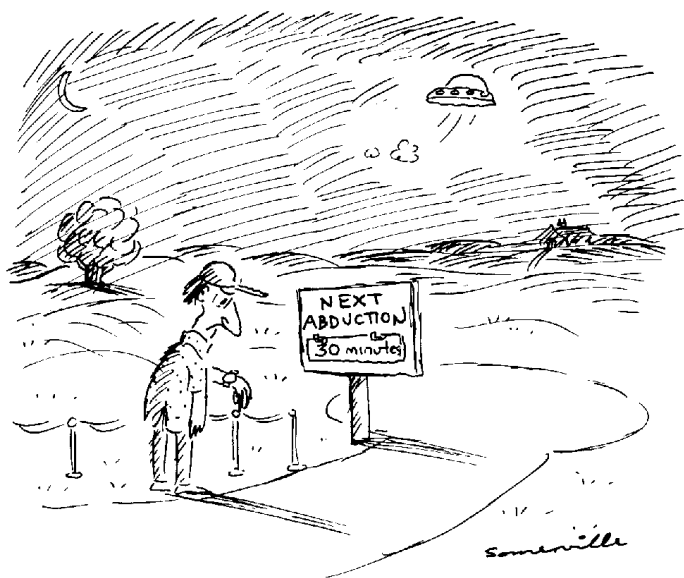

that which will not cause too much havoc for your minds. We came to your Earth from a different world. From other dimensions we came into this dimension. We came to experience, needing to experience density. That which we first heralded had nothing of the density of what you call a "body". The life on this Earth plane was primitive in form, but we took upon ourselves the physical form which is recognizable to you. We sought only to experience material density and to bring knowledge and enlightenment. But we did not confine ourselves to any one, what you call, "geographical location". There were many, and many of our relics and of our teachings are still to be found scattered amidst your land masses and your sea masses.

I was keen to know exactly who these "we" were that the voice of the skull seemed to be talking about, when it continued:

But there are still many among you who seek to find where in your universe we are to be found. But still you cling to the idea that we are of the third dimension and you still cannot grasp the idea that we are of the other dimensions, beyond your rudimentary space-time relativity.

The voice then proceeded to divulge some rather cryptic information about space and time:

We would tell you that the essence of time is an illusion. Time has been created, in fact, by a higher intelligence as a form of control upon the brain and function of the body image. This is a safeguard against corruption of matter but, in essence, is non-existent. Thought exists independently of the body and brain, but time is the creation of matter. Thought is without time. Time, as a mechanism, was introduced to material and current mind only, not to thought or spirit, to keep you bound within the third dimension and within the perimeters of the small planet you call "Earth".

We would urge you to explore with truth and understanding that which the mind is capable of understanding and not that which the brain is restricted to.

Time is related to you as numbers. We offer to you that number and time have no depth. These are merely programmed into the current mind as safeguards, to keep you in time and space. They are a function not really of mind, but of brain. And they are really a dysfunction of brain, to keep you tied to the physical dimensions of the

three-dimensional world. The relativities you call "number", "time" and "space" are a function of the brain related only to the third dimension. This current mind keeps you a prisoner in time and space, in the material, physical world you call "reality". But the delusion of time must remain for a period. Do you understand?

I was not at all sure that I did. Instead I was still trying to work out whose voice this really was and why the crystal skulls had been created in the first place. The voice went on:

We have come now to warn you, because the separation has already begun. The destruction is already beginning to take place. The mind of separation has taken hold and some serious things have already taken place. For you, with your primitive knowledge, have already started something which now cannot be reversed. It was started through your scientists playing with and bending sound and light waves and that which you call "particles" into your atmosphere. You will have noticed that there are many destructive waves now hitting your planet. There will be more destruction brought about by atmosphere intervention, unusual weather patterns and rapid climatic change, and there will be movement of your land masses also.

We wish to tell you that your civilisation has grossly misunderstood the use of light and sound and matter. That is why you have only uncovered that which is closest to you.

But, even now, your scientists and your governments play with toys that they do not understand. They play with light and sound and that which you call "particles" and "radiation", and they will rain havoc. But because the reaction is not immediate and not obviously near to yourselves, you continue and you continue until this very planet will erupt and destroy.

As we have said, your current mind seeks only separation. You have a desire to separate that will lead only to your own destruction. For this is the same mind that caused the Great Flood and caused the previous destruction of many a land mass. But this destruction has begun to happen again already. And we can already feel the influence of this separation in our world. But, at present, you are unaware of this separation because it is of your own making. But we tell you that your Earth will undertake great changes...

Even the body of your planet will change, as with your weather, as with all to do with your Earth as you now know it. There will be changes upon this Earth in the form of the human, the animal and that form you know as "vegetation", and that form which you know as "land mass", and that which you know as "atmosphere".

There will be a disaster that is of great consequence. But, in essence, your "disaster", as you would term it, has already begun. You will find much death amongst your life upon the planet. You will find that which is grown in the ground will cause



THE TWILIGHT ZONE

much change, and you will see that which feeds upon the ground will end up with much death. You will see much destruction due to what you call "radiation" and you will find much pestilence in that which now flies upon your planet. There will be eruptions and disruptions of weather patterns, and much separating of atmospheres. You will have much wind...and your livestock will die in great numbers. Your waters will rise where they should not rise, and your land will be sinking underneath the waves. Land masses will disappear, and seas and oceans will rise.

There will be a great splitting of the Earth...from within the Earth. The magnetic field will shift and is already shifting now. The Earth will be split asunder and the discharge will wander through the Earth and into the atmosphere. The atmosphere is already entering a state of negative pollution. This is what you are doing with your negative energies on the Earth.

And this is why we left these receptacles for you to find, in your time "long ago" when we realised that so many had forgotten their original purpose of incarnation into this physical dimension. When we realised that the mind of separation would take hold and that there would be a great catastrophe on this Earth, we chose to return to our original dimension, but we left behind the legacy of our minds. We knew there would be those whose knowledge and seeking and spiritual progression would turn them towards this path. We knew that because of the disaster that would befall this planet, there would be

those who would be needed to call upon their reincarnational memories to heal, to counsel and to love a world gone mad, a world without knowledge, a world without hope, where the fires of destruction would reign.

But when the time comes it will be the duty of all those who seek spiritual knowledge to instruct others when the Earth moves from its axis. Within this receptacle, and the others we have left you, lies that which you will need. Our knowledge, here crystallised, will be imparted when the right time arrives. It was determined that through these receptacles the minds of one would be activated and would present themselves when your Earth was in need. And this is now beginning to happen, as you say "at this time" and "in this place". We are here to tell you that there is...will be...and has already begun, a great change within your Mother Earth. We urge you to make known to mankind the things which we are to give you, in the hope that the holocaust can be reduced. For although what is given cannot now be changed, its effects can be much diffused.

At this point the voice explained that it was going to leave us now because it could sense that the physical body it was using, presumably meaning Carole, was getting very tired, and so it would have to go. A long humming sound began again, and as it faded away Carole slumped into her chair, completely exhausted and unable to speak for some minutes. It took a few glasses of water to get her to speak again, in a long drawl, like someone drunk. When she

eventually came round she seemed completely unaware of the events that had just passed and was unable to answer any more questions.

We were completely baffled as to what to make of the information Carole had channelled. We had originally been sceptical enough about the idea of psychic communication with spirit beings, let alone beings from another planet or "dimension", whatever that meant, warning us about imminent disaster on a global scale. But our cynicism had already been tempered by what we had heard about Carole's valuable police work and by the fact that Carole herself seemed genuine and honest.

Everyone around us treated the information we heard with a great degree of seriousness and respect, and there was something about the predictions made that had an alarming but still undeniable ring of truth. Indeed, these became even more unnerving when John showed us transcripts of Carole's channelling sessions with the skull from the 1980s. The channelled information always seemed to have been quite consistent. In a session recorded in 1987 the voice had predicted, "Livestock will die in great numbers." This seemed to have particular relevance for us now, having just come from Britain where the BSE crisis had now led to the slaughter of tens of thousands of cattle.

Around nine months later, the prediction about the Earth's magnetic field shifting also took on a sobering degree of truth when we read in an issue of *New Scientist* [30 Mar '96] that it had just been discovered that the magnetic field is indeed beginning to shift. There are even some scientists who now predict that the whole axis of the Earth might be about to do a complete flip [*Guardian*, 21 Mar '97].

At the time, however, we didn't know what to make of everything we had heard. Was this really 'the voice of the skull' speaking through Carole? We just couldn't say. But the strange words remained in our minds as we resumed our more everyday approach to the mystery of where the crystal skulls had really come from.

(Excerpted from Chapter 7, "The Talking Skull", of *The Mystery of the Crystal Skulls*, by Chris Morton and Ceri Louise Thomas, published by Thorsons/HarperCollins Publishers, London, UK, 1997; reprinted by permission. See Reviews pages for further details.)

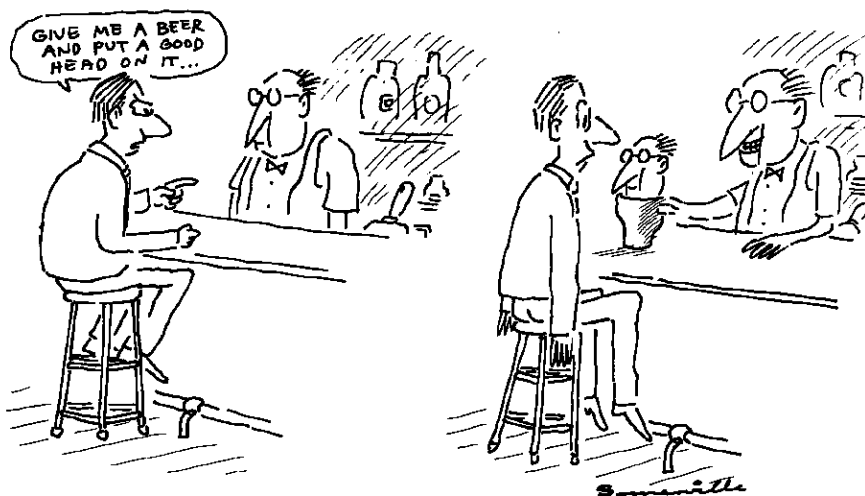

AREA 51/S-4

Secrets Behind the Scenes

In 1991, UFO investigator Wendelle Stevens was contacted by a Delta Force sentry who divulged details of flying saucers and aliens kept at Area 51.

by Wendelle C. Stevens ©1997

From his talk given at the 1997 Australian International UFO Symposium

PO Box 17206
Tucson, Arizona 85731, USA

On Tuesday, 22 October 1991, one of the strangest and most exciting stories of my career in UFO research began to unfold. A young man calling himself Connor O'Ryan called my home in Tucson, Arizona, from Los Angeles and said he wanted to come and see some of my collection of UFO information and pictures. That was about noon of Tuesday.

At about 14:00 hours I received another call from the same voice saying that he feared he may be in danger, because when he went to the bank to draw out money for his trip, he was informed that his account was "frozen"! He tried his Bankcard in the automatic teller machine and it was returned unhonoured. He went to another bank and tried to withdraw money on his Visacard and it also was not honoured. He said he suspected the worst.

He went back and packed his bags and left his apartment. He called me again about 14:45 to say he had something for me if I would get him a bus ticket to deliver it. He said the next bus left his position at 16:00. I raced to my nearest Mail Boxes outlet and wired him \$100 for a ticket to Tucson. After that, I was tied up on my telephone for a few minutes when my line was interrupted by another call saying the money was not at Western Union yet, and time was running out. I assured him that I would go check on it immediately, and that he should check Western Union again in 15 minutes. He did, and the funds were verified, and Western Union verified this to me. The Mail and Western Union sub-station was in a mall across the street from the bus station and he made it in time; but now he began to worry about what he was carrying, and on impulse decided not to carry what he had with him, but to ship it to me to hold for him when he got here.

He made up a package in an automobile starter box and weighted it with rocks to disguise the contents. He then took it to the mail section of the bus station office and shipped it to me at priority rate, registered and insured so that it had to be signed for.

The man arrived in Tucson at 02:30 early next morning and called me, so I went down and picked him up at the Tucson bus station. He did not want to eat, but I was now up and wanted a cup of coffee. We stopped at the Dunkin' Donuts all-night counter near 22nd Street and Craycroft Road, and I had a coffee and he drank a Pepsi-Cola. Then we went to my home and went to sleep.

The next morning, Wednesday, all seemed normal and we went out to breakfast. The young visitor asked a lot of questions about UFOs and my research. He said he had found out about me and my interests in a book on UFOs, among the very few on the subject in the Las Vegas downtown public library, and copied my name and address from it. A call to the Tucson telephone directory service gave him my number.

He said he was a US Marine—a "Seal", an elite Navy Special Forces position—and had been such since his enlistment some nine years ago. He was 29 years old, and for the last nine months he had been assigned to "Delta Force, Team Six", a super-elite cross-service activity that answered to none of the service commands but to a command line of its own, answering directly to the Joint Service Staff. This was all new to me.

He said he was, until one week before, assigned to duty at S-4 in the Area 51 facility of the ACE reservation in Nevada. He said he was a sentry who lived in the quarters at the facility and whose duty post was on Level 2 of a four-level complex. He said there were no sentries below Level 2, as everything below that was electronically controlled and he did not know what was down there. At Level 2 they controlled access to the separate elevators that went down below—one to Level 3 and another one to Level 4. To use one of these elevators it took a card, a thumbprint and a matching retina scan of the right eye. Anyone who was not cleared by this process was immediately arrested.

The sentries worked continuous shifts of four hours on and eight off. They patrolled

their area at attention and were prohibited from looking around or directly at anybody. They were not allowed to talk to each other or to anybody else. Socialisation off-duty was discouraged and little conversation or discussion took place in the facility, making everyone pretty much a loner.

The men were given physical examinations every three months, during which they were always hypnotised for about one hour. Even their most secret thoughts were probed.

These men were allowed three days of rest and recuperation leave in groups and were taken to Las Vegas once a month. They were dropped at the Imperial Palace Hotel on Las Vegas Boulevard in the afternoon of the first day, and were picked up at 16:00 on the third day to go back to their work facility. Rooms were provided in a special reserved section of the Imperial Palace maintained by the security agency. The men were searched on the way out of the secure S-4 facility, and were searched again and given a polygraph test on the way back into the facility.

On his last quarterly physical, our guest was told that he had Hodgkin's disease and would be given a medical discharge, which was done. He was distraught at being kicked out of his choice service and a career which he loved and counted on. He wanted to go all the way to his retirement in this service. He was frightened at the prospect of being ill and debilitated by a killer disease when he felt perfectly well. He had always been very active.

Connor had begun to take an interest in what was going on in the facility, and he began to look around and at things. He saw seven disc-shaped craft stored there in Level 2. Three of them were alike and the remaining four were all different. He saw some of them occasionally taken up to Level 1, and sometimes one would be taken outside when all satellite activity was clear. The craft were kept on rolling platforms, and they were always moved on these same platforms from his Level 2 to

Level 1. There were other sentries on Level 1, whom he did not know.

He saw naked alien bodies pickled in a liquid and preserved standing erect in a large, transparent, tubelike case. A metal band around the waist held the bodies erect. The eyes in one of them seemed to be sunken back some.

Over time, a small camera was successfully taken into the facility, pictures were taken and the film was brought out. This became a dangerous game, and its possible discovery during one of the hypnotic sessions may have been the real reason for his sudden separation. If this was the case, and he really did have Hodgkin's disease, the implications were fearful. He may have

been given this disease by his own superiors to terminate him for what he had seen! This had already occurred to him, and he was very worried because he was still in perfect health and had no history of such a disease in his family.

His retaliation, if this turned out to be true, was to release some 52 photographs taken inside Level 2 of S-4. If successfully brought out, he could blow the lid off such a nefarious operation which was truly the work of "mad scientists".

Connor felt his hand was being forced by the freezing of his money

supply, and he now sought to get out of the whole thing. He shipped his "weapon", the set of 52 photographs, in the starter box only 20 minutes before he got on the bus to come to Tucson. Other sets were strategically stashed in case of intercept of one or more.

Now Connor was waiting anxiously for the box to arrive, the shipping clerk having advised him that it would take three days to get to Tucson. That would mean arrival on Friday, 25 October.

But on Thursday 24th, I found a pale-blue envelope resting in

the brackets on the porch mailbox next to my front door. It bore no address and no stamps, indicating a hand delivery. The return address, printed in the upper left corner of the envelope, was Imperial Palace, 3535 Las Vegas Blvd, South Las Vegas, Nevada 89109. Inside the blue parchment-like envelope was a sheet of similar pale-blue stationery, with the Imperial Palace name and address on the top of the page and a gold crest on the bottom in the right-hand corner.

On that sheet of paper was a message in

He saw naked alien bodies pickled in a liquid and preserved standing erect in a large, transparent, tubelike case. A metal band around the waist held the bodies erect.

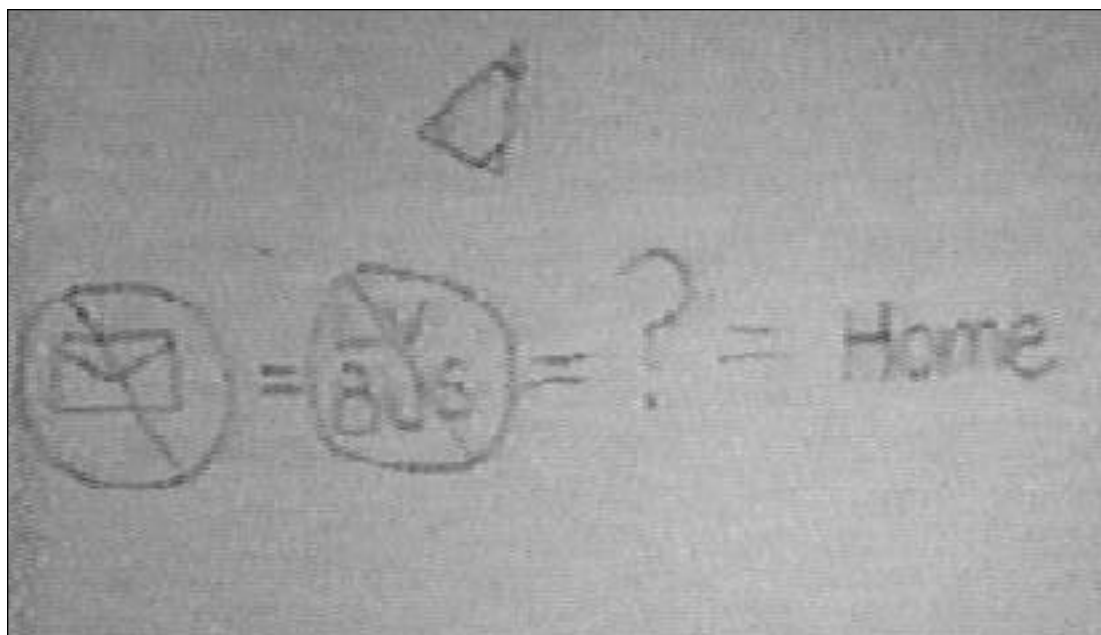

Part of the mysterious note found by Wendelle Stevens outside his home on 25 October 1991.

very simple, childlike letters, of the style used in penmanship practice in elementary school—very difficult from which to judge handwriting characteristics. The message said: "It's to come home." There was a Delta Force symbol with the point of the triangle up, indicating "It's cool"—as we found out later.

I showed the letter to my grandson, Gem Cox, who was sleeping on the porch. Connor was sleeping on the sofa between the porch and my bedroom. He was still asleep. Gem did not know what it was all about, and suggested we wake Connor and ask him about it. When we did, Connor went visibly pale and was immediately alert. He muttered, "Oh God, they're here already!" and shook his head.

Our visitor was now concerned that he also had a tracking device implanted in his body, because, though we'd been watching carefully, we had detected no evidence of Connor being followed and had done everything to detect if he had been.

This angered Connor even more than the possibility of the disease being introduced, because now he had evidence of this. He said he wanted to give us a statement to be held in confidence unless, and until, something was done to him. If he were to be harmed, or any of his friends or family were to be harmed because of him, the statement would be released.

We went out into the desert, to a high spot where all approaches could be watched simultaneously, and video-recorded a two-hour statement for this purpose. Five copies were made and all were dispersed to separate locations away from here—to trusted hands who would release the information if anything happened to us.

At that time Connor told us that there were five people from inside S-4, all working on Level 2, who had become disenchanted over the secrecy of their operation and the way it was being run. They thought the secrecy was misplaced and that the American public ought to know what was there, especially since this place had become commonly known inside as "The Museum", as the primary research activity had been moved elsewhere.

The security people working there were not allowed to use names, but were all identified by a number. Connor's number was 122 and the other three sentries had numbers 123, 124 and 125. A biologist working with the bodies had number 118. These numbers applied only at this facility and were changed as people came and went.

This group had been considering this action and contact for some time and had discussed whom of the UFO researchers they would contact. They went to the public library in Las Vegas and studied all the available material on UFOs, looking for names. They rejected MUFON and CUFOS because they feared those organisations might have been infiltrated by agents of the government. They rejected John Lear as their primary contact because he was too close and was being watched constantly. They rejected George Knapp of TV Channel 8 because he was also too close and might want a story immediately. They chose *us* because they thought we could be persuaded to wait and go at a pace they had decided upon.

Connor was leaving and they had already taken a number of photographs and stashed them securely. Connor would deliver one set to us and arrange for a follow-on plan. Those still inside would take more pictures and try to get documents with official headings on them, discussing the craft and bodies. The biologist would provide dissection reports, autopsies and analyses on the alien bodies, together with photos of the bodies under dissection.

This material was to be brought out periodically and be made available to us through a special drop arrangement or arrangements. We were given our instructions for follow-up and were told where and how it would be done. This could all be published on a signal, to raise the profile of the group in case any one of them was harmed. They hoped that a public outcry would result and that this would save some of them from internal "executions". Such an outcry could lead to lawsuits against the government and subpoenas for evidence, finally bringing down the "house of cards" of security over these important matters affecting us all, our society and our world.

...Connor told us that there were five people from inside S-4, all working on Level 2, who had become disenchanted over the secrecy of their operation and the way it was being run.

They thought the secrecy was misplaced and that the American public ought to know what was there...

Friday morning we were anxiously awaiting delivery of the shipment so we could get the package, when at about 11:30 I went out to see if any mailbox flags were still up. Coming back to the door, I noticed another of those pale-blue Imperial Palace envelopes stuck behind my house number.

This time the message was a white 3" x 5" card with the Delta Force triangle, the point now turned to about the 2 o'clock position, indicating time was running out. Then there was a circle with an envelope in it and a line drawn diagonally across the whole pictogram, indicating no shipment and possibly an intercept of the registered package. The next pictogram was a circle with "LV BUS" written inside; a diagonal line was drawn across that symbol, indicating a possible intercept there, too. That was followed by a big question mark, indicating "What are you going to do now?" But the most threatening part of this message were the last two symbols: one was the word "Home", and the other was two paper matches, indicating a threat of arson.

The arson threat was turned over to the County Sheriff and the local Fire Department for file in case this threat was carried out. If so, it would clearly lead back to Delta Force and Area 51. We have the names of the chain of command leading all the way back to the [then] Secretary of Defense, Dick Cheney, and we have attorneys who are most anxious to initiate such a lucrative action. One of the 52 photos is said to clearly show Dick Cheney inspecting Level 2 of the S-4 facility, where the alien ship and sample bodies are kept and where our man was a sentry on duty. This photo was surreptitiously taken by our Delta Force visitor at that time, after the end of the Gulf War.

Interception of this package of photographs does not mean they are all gone. Other sets were made and stashed in trusted hands for safekeeping in case of loss of some. They can be produced to save a life or to pursue an arson threat carried out by Delta Force or its agents. The evidence is clearly established.

After the third letter from Delta Force, on Saturday 26 October 1991, our man decided they might come in by force and take him, so he went out into my walled backyard, found a dark corner under some big oleander trees, buried his identification cards and covered the whole thing with dead leaves so it looked undisturbed.

We were only absent from home for a short time to go eat something, and we discussed copying his cards and dispersing the copies. When we returned home he went out to get them and they were already gone, leading to speculations that even the ID cards may have tracking devices in them.

That third message was found at about noon, in another sort of envelope; white this time, with a white sheet of paper inside. Again, it had been stuck in the corner of my house numbers at my front door.

This time the message seemed to be an offer. This was truly Orwellian in scope and a very frightening situation for our society.

That day Gem Cox had to go to Phoenix on business and took Connor along with him to see what would happen with a change of location. As expected, the next message from the unseen force was delivered there, in Phoenix, and was found the next afternoon.

The two had detected no evidence of pursuit, though they'd sanitised their trail to the best of their ability. They'd driven very fast, until they could see no other car lights, and then pulled off the road behind some bushes and waited. They did this several times and detected no pursuit.

They had left Tucson late in the evening and got to Phoenix just

before midnight. They arrived at Jim Diletto's and talked with him for about an hour before going to their room in an outbuilding to get some sleep.

About 02:30 in that early morning, Gem Cox was awakened by someone else in their room. He tried to open his eyes and tried to move, but he was completely paralysed! He could only see through a small slit of eyelid opening, and could look down his prone body. He saw four "ninjas" (men in close-fitting black

**He saw four "ninjas"
(men in close-fitting black
bodysuits with padded feet
and black knitted ski-masks)
in there with them.**

bodysuits with padded feet and black knitted ski-masks) in there with them. One was standing over Gem on his bed, straddling his ankles and pointing an automatic weapon at his head. Another similar figure was standing over Connor the same way. Two more "ninjas" were going through their things, looking for something. One came up with a piece of paper from Connor's bag, looked at it, cursed and crumpled it, then threw it towards the door. A fifth man, in a suit, was also there in the room. Nothing was said by any of them. Gem lost consciousness again and he

and Connor both slept until 14:30 in the afternoon!

When they got up and went out to the car, there was another (the fourth) pictographic note in the Delta Force shorthand language showing the triangle pointed back to the 12:00 position, indicating "No rush". Then there were carefully disguised penmanship letters that read: "Situ: Extreme. Please be pat." These were followed by pictograms showing three men, in the step: " = \$\$\$ = No TV, Work on deal. You have 7 days to produce pack or = . We want GW1 to come home. We will call in 48 hrs."

Later on Sunday, 27 October, a fifth note, in a white envelope, was found stuck in the car door. It had a sheet of white paper inside with instructions for them to check into the Motel 6 in Scottsdale and wait.

They did this late on Sunday afternoon, after purchasing an infra-red sensor light and cans of peanuts to get the aluminium pull-off tops.

They rigged the sensor light to come on when someone was just beyond the motel room door, and they inserted peanut-can lids in the crack around the door so as to fall out if the door were moved or the cracks disturbed.

That night, both the light came on and the can lids were knocked to the floor by someone who checked the door and then went away.

The two men checked out the next day. They went out to the parking lot to return to Tucson, and as they approached Gem's red Porsche they saw a sixth envelope pinched into the door crack.

They then thought of their arrival to check into the motel, and how the desk clerk had handed Gem a key that was already laying on the clerk's desk pad in front of him. Thinking that rather suspicious, Gem looked at the key number, affected dislike and said, "Give me another



Wendelle Stevens, during his presentation at the 1997 Australian International UFO Symposium held in Brisbane last October.

room. I don't like this number. I am very sensitive about numbers." The clerk objected but did change the key, and so they ended up in a different room. Now they wondered what would have happened if they had used the first room.

This time the note seemed a little more conciliatory. It had the delta triangle pointing up at 12 o'clock again. Then the note said: "100,000 within 48 hrs for location. No foul play or"—and that was all.

On Tuesday, 29 October, a seventh note was received, again mentioning 100,000 and showing three stick men walking away. The delta triangle was again pointed up, and then it said, "18:00, All be there".

The 48 hours ran out at 18:00 on Wednesday evening, and at 18:15 an eighth note was found stuck behind the house numbers in Tucson again. This one said, "Trouble with money Delay to 13:00 to 16:00 tomorrow". That would be Thursday, 31 October 1991.

We waited all Thursday afternoon, from 12:00 to 18:00, with no further contact. Finally Connor asked for my car so he could go make a call. He came back somewhat disturbed and said he had been told that the orders to "terminate" him had been issued.

At that point we decided to raise Connor's profile so that news of such a "termination" might draw the interest of hundreds of UFO buffs anxious to check out Area 51 and S-4.

I called the Ham Radio Net and asked them to stand by in case something dangerous happened, giving them a few clues and contacts to put the story together. I also called the computer mailboxes and had them stand by for a spectacular release, or for a story about our being taken in on a set-up intended to discredit us. Either way, the story would get much mileage.

There was no contact at all, all day of Friday—very unusual in view of the deadlines.

On the morning of Saturday, 2 November, we found a plain brown envelope behind my house numbers again. This was apparently the end of the negotiations and a final kiss-off. The threat was plain and simple: no more negotiations. "They" would not hesitate to take out my whole neighbourhood if necessary, and the reference, "MALAKIA", meant just that.

Sunday passed and still no contact had been made. Connor was beginning to lose patience in view of the execution order issued on him. He called a friend (his tutor and mentor from earlier in his career) and consulted him on what to do. The friend offered to come and get him and take him to a safe place.

On Monday, 4 November, Connor decided to go get us some stashed evidence to be used in publishing the whole story, if that became necessary to prevent the deaths of his several confederates who by now had certainly been discovered. He timed this to coincide with the arrival of his rescuer in a private plane to take him to safety, or so he thought.

He asked to be dropped at the bus station where there would be safety in numbers, and that is where I took him. His last words were that he would retrieve a stashed package and put it in our hands before he left. He would contact us with instructions in a few hours.

That was the last we saw of our mysterious visitor.

Connor had given me a locker key that he said was for a locker in the Greyhound bus terminal in downtown Las Vegas. He said that there was an envelope, taped up behind the door-locking mechanism in the front of the locker, which I should remove as soon as possible, as there would be a follow-on delivery by his friends inside the S-4 facility if this were removed.

I went to Las Vegas and called John Lear to go with me to the bus station and videotape me as I opened that locker number 424. I had a map of the location of that locker bank and number in the bus station. I found the correct bank of lockers, and the position of the locker number I was looking for—but that number was not there. The locker numbers were in correct order on either side of this position, but one whole bank of lockers was now different. The locker key I had looked exactly like all the other keys in the other lockers in that major number series, but the locker I wanted by number was gone. Its number was on my key.

I went to the locker manager in the terminal and explained my dilemma, and was told that the lockers were a concession, and that the concessionaire did occasionally change lockers for his own reasons, and that, yes, some had been changed just last week.

That ended my contact with this story, except that I had the two-hour videotaped interview with the mysterious Connor O'Ryan.

My house was again searched several times, but that tape was never found because, in fact, it had been in the hands of the Pima County Sheriff's Office ever since it was recorded, and

it was still safe there.

"They" would not hesitate to take out my whole neighbourhood if necessary, and the reference, "MALAKIA", meant just that.

About the Author:

Wendelle Stevens is a retired Lt Colonel who served as a US Army Air Corps test pilot during World War II and then worked out of the Flight Test Division of the Air Materiel Command at Wright Field, Dayton, Ohio. His duty desk was in the Foreign Technology Division of the Air Technical Intelligence Center—the office out of which UFO-related Air Force projects *Sign*, *Grudge* and *Bluebook* were eventually formed. In 1947 he took part in the *Ptarmigon* project to map the entire Arctic land and sea area, and record all anomalous phenomena, even evidence of UFO activity.

From thereon, Wendelle Stevens began amassing what is now arguably the largest collection of UFO photographs in the world. He retired from the US Air Force in 1963 and has pursued his UFO interests ever since, contributing articles to many UFO magazines, both US and foreign, and giving lectures internationally. He has accumulated reams of data from his own investigations of sightings reports over the years. Stevens is not affiliated or aligned with any particular UFO organisations and continues his research at his own expense.

At the QUFON 1997 Australian International UFO Symposium, held in Brisbane last October, Wendelle Stevens 'went public' for the first (and last) time with Connor O'Ryan's story, at the same time showing segments of O'Ryan's videotaped statement (see Video Reviews this issue). Wendelle mentioned that he actually received death threats over the phone as he was preparing to leave the USA to come to Australia to deliver this presentation.



REVIEWS

BOOKS

Reviewed by Ruth Parnell

MIND CONTROL, OSWALD & JFK: WERE WE CONTROLLED?

by Lincoln Lawrence with Introduction
by Kenn Thomas

Publisher: Adventures Unlimited Press,
USA, 1997

ISBN: 0-932813-46-1 (223pp s/c)

Price: AUD\$27.00; NZD\$28.95;

STG£16.00; NFL£32.00; USD\$16.00

Distributors: **Aust/NZ/UK/Eur**— NEXUS
offices; **USA**—Adventures Unlimited,
PO Box 74, Kempton, IL 60946, ph
(815) 253 6390, fax (815) 253 6300.

First published in 1967, *Were We Controlled?* is an underground conspiracy classic that argues that mind-control technologies were an intrinsic part of the JFK assassination scenario. It is written by the pseudonymous Lincoln Lawrence, about whom little is known. However, the context and connections of his story are expanded upon by Kenn Thomas (editor, *Steamshovel Press*) in his weighty, well-footnoted introduction to this welcome new edition.

Lawrence's hypotheses have a compelling logic and deserve recognition especially in view of advances in remote neural monitoring (see NEXUS 3/03), and suggestions that Timothy McVeigh of OK bombing infamy was/is a mind-controlled implantee.

As "The Rumor" goes, a shadowy group ("The Group") with German, Argentinian and possibly Nazi links, engineered a huge NY stock market crash to coincide with the JFK assassination (which they also set up), earning themselves a cool half-billion in the

process. In the late 1950s, a "Mr One" had arranged for Lee Harvey Oswald to "defect" in Moscow to join a "behavior control program". Without his knowledge, he was implanted with a tiny radio receiver and subsequently became a "sleeper", "available anytime to perform assassinations at the will of a remote controller".

Considering when this book was written and the technologies it documents (Radio Hypnotic Intracerebral Control, RHIC, and Electronic Dissolution of Memory, EDOM), it's not hard to believe that, in the ensuing 30 years, mind-control technologies have become increasingly sophisticated and are being selectively, insidiously and regularly used against unwitting populations.

DEADLY FEASTS: Tracking the Secrets of a Terrifying New Plague

by Richard Rhodes

Publisher: Simon & Schuster, USA, 1997

ISBN: 0-684-83260-8 (251pp h/c)

Price: AUD\$29.95; NZD\$34.95;

STG£16.50; NFL£48.00; USD\$24.00;

Distributors: **Aust**—Simon & Schuster, ph
(02) 9417 3255; **NZ**—Macmillan, ph (09)
415 6677; **UK**—NEXUS Office; **Europe**—
NEXUS Office; **USA**—Simon & Schuster,
ph (212) 698 7000.

Deadly Feasts is a warning that we are under serious threat from emerging "stealth" diseases possibly caused by so-called "prion" (pron. "pree-on") protein agents. Not only do they lurk in the meat of animals fed with animal proteins (turning vegetarian ruminants into carnivores), these disease agents may also infect milk and cheese, growth hormones, vaccines, transplant organs, gelatin, soap, leather and even garden bonemeal.

As cases of fatal variant-CJD brain disease are now on the rise, particularly among young adults in Britain and Europe, we may be seeing the first signs of an epidemic and proof that "mad cow disease" has crossed the species barrier (see article in this issue).

Pulitzer Prize-winning author Richard Rhodes begins the story in the mid-'50s with the Fore tribe of New Guinea, where US scientist Dr Carleton Gajdusek and Australian colleagues were studying the brain-eating disease kuru. Gajdusek saw a link between cannibalistic rituals of the women and children and their high mortality rate.

Over the decades he and other scientists observed and researched the similarities between kuru, sheep scrapie, CJD, BSE and other variants which all produce their own version of spongy holes in the brain.

Rhodes' alarming story is one of blood

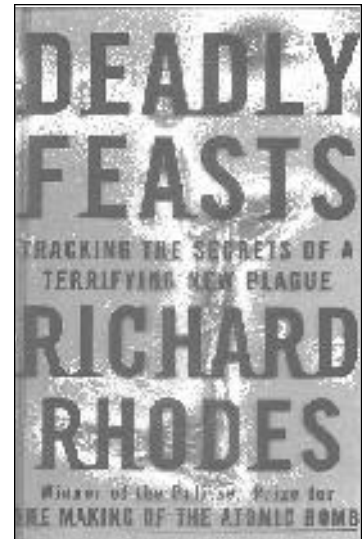

REVIEWS



BOOKS

sweat and tears, of scientific triumphs and occasional opportunism, of the shortsightedness and greed on the part of governments and industry. And while the exact make-up and action of prions are still to be determined (despite the recent, perhaps premature award of a Nobel Prize), we should be very careful about what we consume.

OPENING TO THE INFINITE

by Alice Bryant and Linda Seebach

Publisher: Wild Flower Press, USA, 1997

ISBN: 0-926524-43-7 (300pp s/c)

Price: AUD\$34.00; STG£10.99;

NFL\$34.00; USD\$16.95 + \$4.00 p&h

Distributors: **Aust**—Cameron Books, ph

(0247) 587676; fax (0247) 589047; **UK**—

Counter Culture, ph 01823 698895;

Europe—NEXUS Office; **USA**—Blue Water

Publishing, PO Box 190, Mill Spring, NC

28756, ph (704) 894 8444, 1800 366

0264, fax (704) 894 8454.

There is much more to reality than what we can perceive with the five physical senses of our three-dimensional world. Humans have the ability to be multidimensionally aware, to access hyperspace, to experience layers beyond the known and to integrate these experiences into their lives in the physical world.

All too often, individuals in whom these potentials are highly developed have these gifts socialised out of them at an early age, or may even be diagnosed as mentally ill.

As authors Alice Bryant and Linda Seebach point out in their new book, *Opening to the Infinite*, these multidimensionally-aware individuals are the "trailblazers" of the next

step in human evolution, and their gifts should be recognised and nurtured for what they can teach all of humanity.

While such gifted people have always been amongst the human race—as shamans, sages, visionaries and psychics—Bryant and Seebach believe that increasing numbers of children are being born in recent years with already highly developed awareness of their gifts and their purposes in life.

Expanding their thesis, the authors draw on the experience and wisdom of several such trailblazers who have integrated their gifts into their lives. Taking in the views of key exponents of hyperspatial reality, such as Ingo Swann, Dr James Hurtak, Dr Andrija Puharich, Ken Wilbur, Robert Monroe and Jose Arguëlles, they arrive at crucial definitions of what constitutes the multidimensional human potential inherent in us all.

A COVERT AGENDA: The British Government's UFO Top Secrets...

by Nicholas Redfern

Publisher: Simon & Schuster, UK, 1997

ISBN: 0-684-81937-6 (368pp h/c)

Price: AUD\$29.95; NZD\$34.95 (available

April '98); STG£18.50

Distributors: **Aust/NZ**—Simon & Schuster;

UK—NEXUS Office.

According to the evidence presented by UFO researcher/author Nicholas Redfern in his book, *Covert Agenda*, British airspace has been penetrated regularly by UFOs since at least the late 1940s.

While the official UK Ministry of Defence stance is not to acknowledge that UFOs and alien races may be a potential threat, the documents uncovered in recent years confirm that the threat has been real enough to justify the existence of several top-secret

groups devoted to investigating as well as covering up the mystery. Implicated are the DI55 and the Directorate of Scientific and Technical Intelligence (DSTI) under the Defence Intelligence Staff (DIS), the Royal Air Force Provost and Security Services, the Flying Complaints Flight and others. Their association with the US National Security Agency and Defense Intelligence Agency attests to the global nature of "the threat".

In *Covert Agenda*, Nicholas Redfern argues that the documentary evidence he's collected from previously classified files, as well as from RAF and civilian pilots, military personnel and radar operators who've had varying manner of close calls with UFOs, speaks so loudly that it's time the conspiracy of silence was ended. Whether this conspiracy is based on the truth being too shocking to be revealed, or the powers-

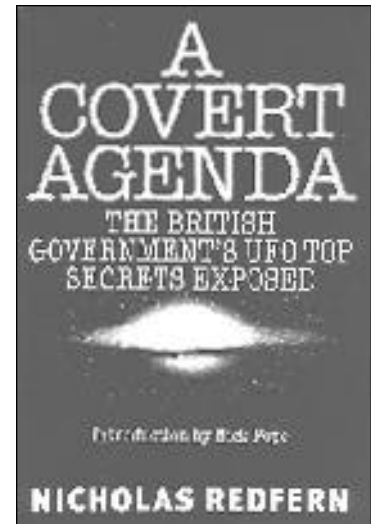



REVIEWS

BOOKS

that-be being powerless to handle the threat, or something else, is open to conjecture.

Redfern is certainly convinced that there is an active alien presence on Earth (though he doesn't make distinctions between different races of aliens reportedly involved here), and that it may soon be officially confirmed.

VIRTUAL GOVERNMENT: CIA Mind Control Operations in America

by Alex Constantine

Publisher: Feral House, CA, USA, 1997

ISBN: 0-922915-45-8 (303pp s/c)

Price: AUD\$30.00; STG£n/a; NFLf30,00; USD\$14.95 + p&h

Distributors: **Australia**—Cameron Books, ph (0247) 587676; **UK**—Turnaround, ph 0171 609 7836; **Europe**—NEXUS Office; **USA**—Adventures Unlimited, ph (815) 253 6390, fax (815) 253 6300.

Conspiracy researcher Alex Constantine's new book, *Virtual Government*, goes far to explain why the United States seems to exist in a "parallel universe". Ironically, sci/tech advances have helped consolidate the power base of a secret government whose reality is far from virtual to its victims.

Constantine (author of *Psychic Dictatorship in the USA*) traces the murky beginnings of mind control to at least the last days of WWII when top Nazi scientists, military brass and businessmen were integrated into the US military-intelligence-industrial complex. Rising from the ashes after the War were new "alphabet agencies" like the CIA and NSA. Hellbent on fulfilling their charters ever since, mind-control operations have been both their *modi operandi* and their *raison d'être*.

In *Virtual Government*, Constantine critiques a diverse cast of (mostly shady) characters within their multi-layered plots: the CIA's Operation *Mockingbird* that engineered the takeover of the US press so as to program public opinion; manipulation of cults as fronts for mind-control ops; development of "alien abduction" covers; disinformation behind remote viewing (some exponents perhaps being given too scathing a treatment); conspiracy surrounding the O.J. Simpson case; Nazi-style psychiatry in Canada; horrific abuse of children; controversy over Timothy McVeigh being a programmed "patsy"; and much, much more.

Each section of this book is heavily referenced (though, regrettably, an index missing), and contains enough leads and links to take even the most ardent conspiracy researchers into new areas of investigation.



THE FEMINIZATION OF NATURE: Our Future at Risk

by Deborah Cadbury

Publisher: Hamish Hamilton/Penguin Group, London, UK, 1997

ISBN: 0-241-13746-2 (314pp h/c)

Price: AUD\$35.00; NZD\$49.95;

STG£17.99; NFLf60,00; CAN\$35.00

Distributors: **Aust/NZ/UK/Canada**—Penguin Books; **Europe**—NEXUS Office.

We are in the grip of an environmental and health disaster that could spell the end of our species, and it is of our own making. Some man-made chemicals, such as DDT, PCBs, pesticides and phthalates have been found to behave like oestrogens when released into the environment, and changes observed in animals and humans (e.g., a decline in male sperm quantity and quality, and a rise in testicular, prostate and breast cancer) are now known to be linked.

How this important connection was made is described in *The Feminization of Nature*, by BBC TV science journalist Deborah Cadbury, who produced the acclaimed documentary *Assault on the Male* in 1993.

Cadbury examines the compelling evidence from key researchers in the field—such as Prof. Niels Skakkebaek (the Danish male-infertility specialist who found a 50 per cent decline in sperm count over a 50-year period), Dr Theo Colburn (the scientist who set alarm bells ringing over sex changes in Florida alligators with her co-authored book, *Our Stolen Future*), and Prof. John McLachlan (who identified xeno-oestrogens in the environment over 20 years ago).

So, what options do we have to alleviate this mess, short of banning all suspect chemicals? We can adopt strategies that minimise our exposure to chemicals, pesticides

REVIEWS



BOOKS

and plastics; we can (try to) drink pure water, reduce our fat intake (many chemicals accumulate in fatty tissue) and eat organically-grown foods (Danish organic farmers have sperm counts almost twice the national average). But is it all too late?

LIFE EXTENSION: Disease Prevention and Treatment Protocols 1997

by William Faloon

Publisher: Life Extension Media, 1997

ISBN: 0-9658777-0-1 (282pp s/c)

Price: AUD\$29.95 + AUD\$5.00; NZ add

AUD\$12.00; STG£n/a; USD\$26.95;

CAN\$33.00

Distributors: **Aust/NZ**—Life Extension Australia, PO Box 2041, Meadow Heights, Vic. 3048; ph (03) 9302 3624, fax (03) 9302 3045; **UK/Ireland**—Tony Quinn

Health Centre, ph (353) 1830 4211;

USA—The Life Extension Foundation, PO Box 229120, Hollywood, FL 33022-9120, ph (954) 766 8433, 1800 841 5433, website: www.lef.org.

Much needless suffering is caused because people are not aware that proven alternative cures and treatments for their various illnesses already exist. By publishing this book of "wellness" protocols, The Life Extension Foundation hopes to dispel ignorance and alleviate pain. The Foundation, founded in the US in 1980, funds scientific research and promotes products aimed at improving the quality of life.

The majority of the protocols covered in this book have been validated in studies that have gone through the peer-review process and been published in the world's most

respected medical journals. Unfortunately, most of the advances have been passed over by the medical establishment despite their scientific and clinical validation.

Over 100 LEF treatment protocols are included, covering a range of physical and mental illnesses from allergies and depression to vertigo and yeast infections. The emphasis is on the correct balance of natural, non-toxic alternatives including anti-oxidants, vitamin, herbal and mineral supplements, and improved dietary regimens—all, of course, to be considered in consultation with a qualified health-care professional. The sections on treatment of cancers are particularly detailed and noteworthy.

Included in the appendices are caveats that individuals with specific problems should be aware of when considering particular alternative therapies, plus an extensive reference section that relates to each disease and protocol discussed in the book.

WHERE SCIENCE WENT WRONG

by Peter Bros

Publisher: Financial Book Partners, Springfield, VA, USA, 1997

ISBN: 0-9627769-7-1 (226pp s/c)

Price: AUD\$28.00; NZD\$n/a; STG£n/a;

NFL£34.00; USD\$15.95 + p&h

Distributors: **Australia/NZ/UK/Europe**—NEXUS offices; **USA**—Financial Book Partners, ph (703) 971 9141, fax (703) 971 1628; Adventures Unlimited, ph (815) 253 6390, fax (815) 253 6300.

With a title as blatant as *Where Science Went Wrong*, readers can expect a certain amount of vitriol, and they certainly won't be disappointed, for author Peter Bros is utterly scathing in his criticism of empirical science. Indeed, he argues that none of its claims has any basis in physical reality.

Bros asserts that fundamental scientific "facts" are nothing but misconceptions—beliefs that are piled up on top of misperceptions that lead to further misconceptions, creating a fabric of falsehood. Basic questions about how physical reality operates, what causes things to move, what the nature of energy and light really is, have not been answered by empirical science, yet we have taken basic assumptions into our belief systems as though they were fact. We have confused properties with causes, e.g., we assume gravity to be the result of an unknown force acting on matter, but fail to realise this gives no explanation for what causes the force in the first place.

Peter Bros' thesis is equally applicable to the atomic as well as the cosmic universe, and without resorting to equations (who needs them when they're wrong anyway?), he presents a well-reasoned argument that shows up the anomalies and logical fallacies

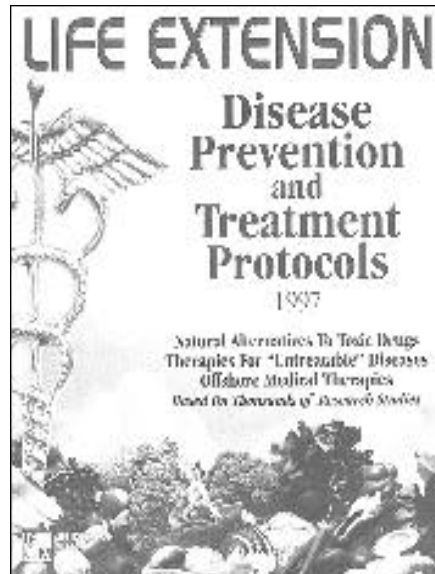



REVIEWS

BOOKS

in scientific doctrine in an entertaining, often extremely irreverent manner.

While Peter Bros sure isn't winning friends amongst the scientific orthodoxy, his views will surely help reshape our thinking into the next century and beyond. But if you want to know how he resolves this crisis in science, you had better refer to other books in his Copernican Series.

THE MYSTERY OF THE CRYSTAL SKULLS: Unlocking the Secrets of the Past, Present and Future

by Chris Morton & Ceri Louise Thomas

Publisher: Thorsons, UK, 1997
ISBN: 0-7225-3485-X (395pp h/c)
Price: AUD\$55.00; NZD\$49.95;
STG£22.00; NFLf63,00

Distributors: Aust/NZ— HarperCollins Publishers; UK/Europe— NEXUS offices.

For we media-watchers at NEXUS, the UK-sourced TV documentary, *The Mystery of the Crystal Skulls*, was one of the viewing highlights of 1997. Now, its independent producers, Chris Morton and Ceri Louise Thomas, have expanded their fact-finding into an in-depth book.

According to various native legends, there are 13 crystal skulls in existence, but not all of the skulls found so far are part of this esteemed group. There are more that are yet to be discovered—and they will be, according to transmissions from the most famous crystal skull of all, the Mitchell-Hedges skull, found in Belize in the mid-1920s (see *Twilight Zone* this issue, and *NEXUS* 2/22).

During channelled communication sessions, this crystal skull conveys messages from an extradimensional intelligence—on the existence of other skulls, their creation by thought, and their purpose as information storage and communication vehicles.

Some of the skull's messages point to imminent discoveries of vestiges of their long-lost civilisation in Australia, under the water near Bimini and in the Dead Sea. Others are warnings about the state of our scientific ignorance, our erratic weather, livestock dying in great numbers, the Earth's magnetic field shifting and the planet's axis tilting. And still, it is not yet time for all the skull collective's records to be revealed!

In considering the wealth of knowledge passed down by the Maya and Aztec native people, the scientific evidence that defies analysis, the otherworldly warnings and the life-changing effects on those who deal with some of these skulls, Morton and Thomas conclude that they have important spiritual messages to be heeded for our times.

THE SUPERGODS

by Maurice M. Cotterell

Publisher: Thorsons, UK, 1997
ISBN: 0-7225-3462-0 (253pp h/c)
Price: AUD\$39.95; NZD\$49.95;
STG£16.99

Distributors: Aust/NZ/UK— HarperCollins Publishers, Thorsons.

Author, scientist and engineer Maurice Cotterell unravels a little more of the mystery of the Maya of Central America in his latest book, *The Supergods*.

He reiterates the extraordinary astronomical and mathematical knowledge possessed by the Maya, whose calendar began in 3113 BC with the "birth of Venus"—a timing which suggests that a magnetic field reversal of the Sun occurred then, which was strong enough to cause Venus to shift on its axis. Cotterell discovered that the Sun's magnetic field reverses itself every 3,740 years, and that the long-term sunspot cycle reflects the rise and fall of civilisations. He has decoded numbers relating to this from many artefacts, suggesting that the Maya had a clearer window on the universe than perhaps any other civilisation that has existed on Earth. (The Appendices cover this in great detail.)

Significantly, the Temple of Inscriptions at Palenque and its treasures, the tomb of Pacal Votan and Lid of Palenque (dated to circa 743-783 AD) contain clues to the hidden mysteries of the Maya cosmos. The very structure of the Temple has correlations with the golden mean *phi* ratio of 1.618:1. By superimposing drawings from the Lid on top of each other and highlighting key sections in colour, Cotterell continues to find new images revealed which suggest the fulfilment of important prophecies in our times.

Cotterell contends that Pacal Votan was not only known by different names in the



REVIEWS



BOOKS

region over the millennia due to his reincarnating at key periods, but was a "Supergod" on a par with (if not one and the same as) Krishna, Buddha and Jesus Christ who came to Earth "on a mission to save mankind".

JOURNEY INTO THE NEW MILLENNIUM: Transmissions from Sirius by Wendy Munro

Publisher: Triad Publishers, Cairns, Queensland, Australia, 1997
ISBN: 0-646-23473-0 (244pp s/c)
Price: AUD\$25.00; NZD\$/n/a;
STG£10.50; USD\$/n/a
Available: Aust/NZ/UK/USA— NEXUS offices.

According to various channelled and esoteric sources, humanity (indeed, the entire planet) is undergoing a total physical and spiritual transformation. One particular source, channelled from the Sirius system by Wendy Munro (a Western Australia-based psychologist and clairvoyant of 20 years' experience), not only has messages in common with other high-integrity channelled material, it has a great deal more to add. Munro has painstakingly gathered many years of Sirian transmissions for her book, *Journey into the New Millennium*.

The Sirian entities have a keen, compassionate interest in our development, and reveal details about alien influences in our past that have been detrimental to our progress. Indeed, they claim that the barriers placed on our genetic structure and endocrine systems have now been removed and are being "recalibrated" to accept the higher vibrational energies that have been



coming in through a vortex from Sirius in the last few years. Our metamorphosis into multidimensional awareness should be complete by the year 2012—when time as we know it will cease, as the Maya have said.

With an emphasis on love, joy and freedom from fear, the Sirians are assisting us on our great Aquarian Age adventure, providing information on 'the big picture', on interdimensional intelligences and cosmic energy, the nature of time, space and mind, Earth changes, new technologies and arts, health and longevity, alchemy, magic, and more. Despite imminent trials and tribulations, we have a golden future ahead of us.

VACCINATION: A Parent's Dilemma by Greg Beattie

Publisher: The Oracle Press, Aust, 1997
ISBN: 1-876308-00-1 (144pp s/c)
Price: AUD\$22.00; NZD\$25.00;
STG£10.50; USD\$22.00 (prices inc. p&h)
Distributors: **Australia/USA**— NEXUS Magazine, ph +61 (0)7 5442 9280, fax +61 (0)7 5442 9381; **NZ/UK**—NEXUS offices.

Concerned parent Greg Beattie decided to investigate the vaccination issue when his first child reacted adversely to a measles shot. He and his wife Jacqui chose to discontinue vaccinations for this child and their subsequent six children until they could be convinced of the safety of the vaccines. Their in-depth investigation of "the literature" could not change their minds.

Meantime, Beattie founded a community-based vaccination awareness group to disseminate information that seemed to have escaped the attention of doctors. His "encyclopaedic knowledge" of the subject came to the fore when his local Maroochy Shire Council, in Queensland, refused entry to one of its child-care facilities to two of their unvaccinated children. Challenging the Council's decision, Beattie took his case to the Human Rights Commission in Brisbane.

Despite his own rigorous cross-examination of the Council's "expert" witnesses, and evidence presented by notable researcher Viera Scheibner, PhD, the Commissioner found against him in a decision that smacks of a lack of grasp of the facts, a travesty of administrative justice or a set-up.

Greg Beattie's book, *Vaccination: A Parent's Dilemma*, is in part a record of his test case but more so it is an exploration of the alleged benefits of vaccination which, when the literature is carefully examined, amount to very few. Beattie presents a balanced, rational analysis of the statistics associated with vaccination for whooping cough, measles, polio and other diseases and recommends that the proven dangers must be considered by all concerned parents.



REVIEWS

TOXIC DECEPTION

by Dan Fagin, Marianne Lavelle and the Center for Public Integrity

Publisher: Birch Lane Press, USA, 1996
ISBN: 1-55972-385-8 (319pp h/c)
Price: AUD\$45.00; STG£22.50;
NFL\$50.00; USD\$24.95; CAN\$34.95
Distributors: **Aust**—Cameron Books, ph (02) 4758 7676; fax (02) 4758 9047;
UK/Europe—NEXUS offices; **USA/Canada**—Carol Publishing Group, ph (201) 866 0490.

The pervasiveness of toxic chemicals in our air, soil and water, in our food and in our homes, is mind-bogglingly alarming; but the complicity of chemical companies and regulatory agencies in keeping toxic products on the market (despite safer, cheaper alternatives available) is truly diabolical.

As suggested in the subtitle, "How the Chemical Industry Manipulates Science, Bends the Law, and Endangers Your Health", *Toxic Deception* exposes the chemical manufacturers' dirty tactics and practices, and while it focuses on the dire state of the US, its messages are applicable everywhere. It is the result of a three-year research project by the Center for Public Integrity, a non-profit group devoted to ethics-related issues. Environmental journalists Dan Fagin and Marianne Lavelle were recruited to the project, interviewing 200 key sources over two years.

The authors concentrate on four carcinogenic chemicals—Atrazine and Alachlor weed-killers, perchloroethylene (used in dry cleaning), and formaldehyde (the ubiquitous preservative/binder)—but experiences are similar with hundreds of other chemicals. Horror stories involve: falsification of data; manipulation of research results; denigration

and persecution of independent scientists and concerned citizens at odds with the industry; use of medical interest groups, PR fronts and the media in "damage control" to allay valid public health concerns; perversion of the course of justice; out-of-court payments with "no talk" clauses; and more.

But rather than leave us feeling totally hopeless and helpless, the authors do suggest strategies by which we can reduce the chemical risks in our lives and sidestep a corrupt system that is blind to Nature.

THE ESTROGEN ALTERNATIVE

by Raquel Martin with Judi Gerstung

Publisher: Healing Arts Press, USA, 1997
ISBN: 0-89281-645-7 (217pp s/c)
Price: AUD\$24.95; NZD\$32.95;
STG£10.99; USD\$12.95

Distributors: **Aust**—E. J. Dwyer P/L, ph (02) 9550 2355; **NZ**—Tandem Press, ph (09) 480 1452; **UK**—Deep Books, ph 0171 232 2747; **Europe**—NEXUS Office; **USA**—Healing Arts Press, ph (802) 767 3174, 1800 246 8648; **Canada**—Publishers Group West; Alive Books, Toronto.

Enough women have found the side-effects of synthetic hormone replacement therapy (HRT) so severe that they are resorting to class-action lawsuits. If only they (and their doctors) had known about safer, natural alternatives sooner...

This new book, *The Estrogen Alternative*, is a welcome addition to the now steadily growing body of literature on options that are low in side-effects and high in add-on benefits. Health writer Raquel Martin, a sufferer of early menopause, went on a mission to explore alternatives to synthetic HRT drugs when these were creating effects worse than her original problems. In producing this book she has collaborated with Judy Gerstung, DC (who has a special interest in prevention of osteoporosis), and worked extensively with Dr John Lee (who has years' clinical experience with natural hormone alternatives). Her approach is balanced, practical and personalised.

Martin has also drawn on scientific and medical studies which prove the efficacy of natural progesterone not only in alleviating menopausal symptoms, but also in treating PMS, endometriosis, fibroids, osteoporosis and cancer. Natural progesterone is derived from wild yam, containing diosgenin, a precursor of a number of hormones which is close to the form produced by our bodies—certainly closer than the synthetic varieties.

The numerous success stories that Martin cites are testimony to natural progesterone's benefits. Women (and doctors) keen to explore this option will find useful advice, references and resources (though US-oriented) included in the Appendices of this book.

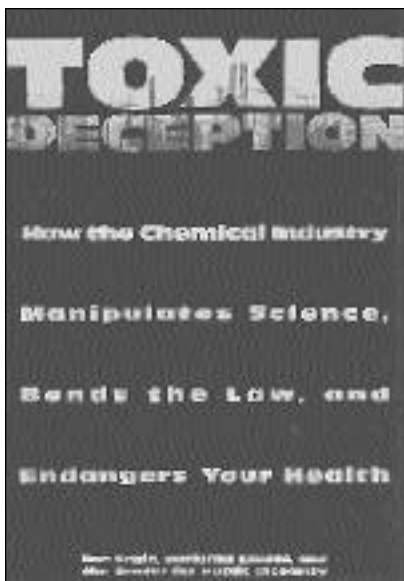

REVIEWS



VIDEOS

Reviewed by Duncan Roads

1997 AUSTRALIAN INTERNATIONAL UFO SYMPOSIUM VIDEOS

Producer/Distributor: Global Vision Productions, PO Box 246, Brunswick Heads, NSW 2483, Australia, ph 1800 628316 toll-free in Aust, fax +61 (0)2 6680 1881, e-mail gvision@om.com.au

Prices: see below. Postage: AUD\$7.00 in Australia; overseas AUD\$12.00 plus \$5.00 each extra tape; for other formats (e.g. NTSC in USA) add AUD\$10.00 per tape.

The 1997 Symposium had the biggest and best line-up of ufology 'names' ever assembled in Australia. The presentations were high quality, and a good time was had by all. The standard of these videos is well above average for UFO conference tapes.

SIMON HARVEY-WILSON (Australia)
CLOSE ENCOUNTERS, CONSCIOUSNESS AND THE PARANORMAL
Price: AUD\$30.00

JOE LEWELS, PhD (USA)
THE GOD HYPOTHESIS: NEW WORLDS DISCOVERED
Price: AUD\$35.00

TONY KENNISH (Australia)
CROP CIRCLES 1997
Price: AUD\$35.00

DR JAMES HURTAK (USA)
EXTRATERRESTRIAL & ULTRATERRESTRIAL REALITIES FOR THE FUTURE
Price: AUD\$45.00
Very informative presentation overviewing many types of aliens reported from around the globe. Excellent visuals.

JAMES COURANT (USA)
SECRETS OF THE SECRET-KEEPERS: WHAT INSIDERS KNOW ABOUT UFOs
Price: AUD\$35.00

ADEMAR GEVAERD (Brazil)
NEW UFO OBSERVATIONS IN BRAZIL
Price: AUD\$29.00
Fascinating overview and update on the famous Varginha ET incidents in Brazil.

REV. GLENNYS MACKAY (Australia)
ALIEN CONTACT, HYPNOSIS AND STRANGE PHENOMENA
Price: AUD\$30.00

GRAHAM BIRDSALL (United Kingdom)
UFO ACTIVITY IN THE UK
Price: AUD\$35.00
Brilliant speaker, great presentation with excellent visuals. A must-get video!

PROFESSOR SUN SHI LI (China)
UFOs IN CHINA
Price: AUD\$40.00

WENDELLE STEVENS (USA)
THE MARINE SENTRY FROM AREA 51
Price: AUD\$35.00
Wendelle Stevens' article in this issue of NEXUS is a transcript of his 'bombshell' lecture. Get this video for the full picture.

MARTIN GOTTSCHALL, PhD (Australia)
THE SEARCH FOR ARTIFICIAL GRAVITY
Price: AUD\$35.00

BUDD HOPKINS (USA)
THE UFO PHENOMENON
Price: AUD\$40.00
Hopkins presented an entirely different talk from that published in the *Proceedings*. Instead, he pushed us to believe there are only Grey aliens, and any other aliens we may have seen are just memory implants put there by nasty Grey aliens! Hmmmm...

WARREN ASTON (Australia)
DISCOVERING THE ALIEN AGENDA
Price: AUD\$30.00
Presents the Udo Wartena case as a springboard for exploring some fascinating aspects of UFO research itself.

CECILIA DEAN (USA)
Price: AUD\$30.00
Protocols for handling UFO experiencers.

ROBERT DEAN (USA)
THE TIME HAS COME: THE GREATEST STORY...MUST NOW BE TOLD
Price: AUD\$35.00
A great visual round-up of UFOs through history; plus a description of his own experiences at SHAPE (the military arm of NATO). Very inspirational ending!

GIORGIO BONGIOVANNI (Italy)
FROM THE HEAVENS TO EARTH
Price: AUD\$45.00
The famous Italian stigmatist shares his message which the Virgin Mary gave to him in Portugal in 1989. Also presents some interesting Russian UFO material.

ALFRED BIELEK (USA)
THE PHILADELPHIA EXPERIMENT
Price: AUD\$45.00
Includes a history of the Philadelphia Experiment, the Montauk Project and his involvement in these classified projects.

PANEL OF SPEAKERS
Price: AUD\$45.00

GIORGIO BONGIOVANNI (Italy)
A SPIRITUAL HEALING EVENING
Price: AUD\$48.00



REVIEWS

AUDIO

Reviewed by Richard Giles

KILIM

by Nikola Parov

Producer: Nikola Parov for Rykomusic, UK, 1997

Price: AUD\$30.95, USD\$15.98 (CD)

Distributors: **Aust**—Festival Records, ph (02) 9660 4022; **UK**—Hannibal/Rykodisc, London; **USA**—Hannibal/Rykodisc, Salem.

Out of the Riverdance phenomenon, a huge creative surge has been born. Nikola Parov was a part of the orchestra. On *Kilim* he's taken music and instruments from his Hungarian background, and with backup from other Riverdance musicians has produced an exciting middle-European treat. Some incredibly foot-stamping sounds on the album, especially the first track, "Anonym", are mixed with softer pieces like "Trance Danubis" and "The Diva's Smile", making it a fine collection of creative music.

DEEP IN DIDGE

by Tribal Trance

Producer: Andrew Higgins for Tribal Trance, Queensland, Australia, 1997

Price: AUD\$14.95 (cass); AUD\$24.95 (CD) (inc. local & overseas p&h) (51mins)

Distributor: **Aust**—Tribal Trance Records, c/- Post Office, Mapleton, Qld 4560.

Local Sunshine Coast musicians Matt Pickup, Penny Lane, Nelson Lane and Rodger Bradshaw have released their second album. Their first, *Didgin' in the Dirt*, won a regional award, and *Deep in Didge* has since won a production award. Matt's didgeridu playing is some of the most unique and laudable didge-playing I have heard. He seems to hold the soul of the didge spirit in his heart. Sensitive vocals and a deep attunement to the Australian world sound make this an excellent album.

HALIM

by Natacha Atlas

Producer: Essam Rashad for Warner Chappell Music Ltd, UK, 1997

Price: AUD\$29.95 (CD) (71mins)

Distributors: **Aust**—Shock Records, ph (03) 9482 3666; **UK**—Beggars Banquet, ph 0181 8702 9912.

This woman is absolutely wild! If you love that full Eastern sound of traditional Arab/Moroccan/Egyptian music mixed with modern arrangements, then Natacha Atlas will wow you on *Halim*. She grew up in the Moroccan suburbs of Brussels, becoming devoted to Arab culture. She's worked with Peter Gabriel, Jah Wobble and Trans-Global Underground, and contributed to the soundtrack of the movie, *Stargate*. Described var-

iously as "thrilling", "sulky", "evocative", "divine" and "a national treasure", Natacha Atlas has the voice of a goddess combined with the power to turn your legs to jelly.

MUSIC OF OLYMPIC NATIONAL PARK by Mars Lasar

Producer: Mars Lasar for Real Music, Sausalito, CA, USA, 1996

Price: AUD\$19.95, USD\$9.98 (cass); AUD\$29.95, USD\$15.98 (CD) (57mins)

Distributors: **Aust**—New World Productions, ph (07) 3367 0788; **USA**—Real Music, ph (415) 331 8278.

Situated in the heart of Washington state and spread over almost a million acres, Olympic National Park is one of America's great wilderness areas, rich with lakes, mountains and meadows, elk, deer, salmon, whales and seals. Mars Lasar's newest work is grand, panoramic music that recreates the incredibly wild feel of the rivers, glaciers and forests of the park. An exceptional album, surpassing all Lasar's previous work.

TRAVEL THE WORLD WITH PUTUMAYO (A compilation)

Producer: Dan Storper for Putumayo World Music, NY, USA, 1997

Price: AUD\$19.95, USD\$9.98 (cass); AUD\$29.95, USD\$15.98 (CD) (59mins)

Distributors: **Aust**—MRA Entertainment, ph (07) 3849 6020; **USA**—Putumayo World Music, ph (212) 995 4458.

Putumayo Music began in 1990 when Dan Storper set out to bring music to people from other cultures in the world. His first release was in 1993. *Travel the World...* celebrates the release of 12 albums and includes samples from each. They range from the island music of Maria Alice, the Celtic swing of Capercaillie, the musical strength of jazz guitarist Brian Hughes (who plays lead guitar for Loreena McKennitt), the women's songs of Vonda Shepard, the African pop sound of Wadini, and more. Laid back, international music.



Continued from page 14

13. Picard, Anne, "Blood withdrawal to cost \$15 million", Toronto *Globe and Mail*, 5 September 1995, pp. A1, A2.
14. Slinger, Sonja, "Suspect blood product withdrawn", *The Daily News*, NZ, 11 May 1996.
15. Morgan, Janet, "Blood to be screened for CJD", *BMJ* (1996) 313:441.
16. Hall, Celia, "Blood donors screened for link with CJD", *The Daily Telegraph*, London, 23 Aug 1996.
17. Créange, Alain; Gray, Françoise; Cesaro, Pierre; Adle-Biassette, Homa; Duvois, Christophe; Cherqui, Daniel; Bell, Jeanne; Parchi, Piero; Gambetti, Pierluigi; and Degos, Jean-Denis, "Creutzfeldt-Jakob disease after liver transplantation", *Annals of Neurology* (1995) 38:269-271.
18. Cooke, Jennifer and Beale, Bob, "The mystery of the secret epidemic", *The Sydney Morning Herald*, 21 May 1994, Spectrum pages 1A and 4A.
19. Dealler, Steven, "Bovine spongiform encephalopathy: Disease is due to pressure on farming industry", *BMJ* (1996) 313:171.
20. Lacey, Richard W. and Dealler, Steven F., "The transmission of prion disease: Vertical transfer of prion disease", *Human Reproduction* (1994) 9:1792-1796.
21. Anderson, R.M., Donnelly, C.A., Ferguson, N.M., Woolhouse, M.E.J., Watt, C.J., Udy, H.J., MaWhinney, S., Dunstan, S.P., Southwood, T.R.E., Wilesmith, J.W., Ryan, J.B.M., Hoinville, L.J., Hillerton, J.E., Austin, A.R. and Wells, G.A.H., "Transmission dynamics and epidemiology of BSE in British cattle", *Nature* (1996) 382:779-788.
22. Hooper, John, "Britain evaded BSE checks for Europe", *The Guardian Weekly*, London, w/e 1 September 1996, p. 9.
23. Radford, Tim, "700,000 BSE cattle 'fed to humans'", *The Guardian Weekly*, w/e 8 September 1996, p. 9.
24. Bates, Stephen, "EU hushed up BSE scandal for five years", *The Guardian Weekly*, w/e 8 September 1996, p. 1.
25. Pearce, Fred, "BSE may lurk in pigs and chickens", *New Scientist*, 6 April 1996, p. 5.
26. Bonfigliani, Catriona, "Cooking risk from mad cow beef, Aust researcher warns", *AAP*, 22 March 1996.
27. Nair, Sumati, *Imperialism and the Control of Women's Bodies: New Hormonal Contraceptives, Population Control and the World Health Organization*, The Campaign against Long-acting Hormonal Contraceptives, London and Amsterdam, 1989.
28. Shiva, Vandana, "Development as a new project of western patriarchy", in *Reweaving the World: The Emergence of Ecofeminism* (editors: Diamond, Irene and Orenstein, Gloria Feman), Sierra Club Books, San Francisco, 1990, pp. 189-200.
29. Hynes, H. Patricia, *Taking Population Out of the Equation: Reformulating I = PAT*, Institute on Women and Technology, North Amherst, Massachusetts, USA, 1993.
30. Hartmann, Betsy, *Reproductive Rights & Wrongs: The Global Politics of Population Control*, South End Press, Boston, USA, 1994.
31. Pearce, Fred, "Dead cows don't fart...or belch", *New Scientist*, 31 August 1996, p. 5.

About the Author:

Lynette Dumble, PhD, MSc, is a feminist scientist whose past academic appointments include: senior research fellow at the University of Melbourne's Department of Surgery at the Royal Melbourne Hospital; visiting transplantation scientist at the University of Oklahoma in Tulsa and University of Illinois in Chicago; and visiting professor of surgery at the University of Texas in Houston.

Dr Dumble has had more than 200 articles published on the science, politics and ethics of organ transplantation and on women's health, and presently lectures on science, technology and gender in the Department of History and Philosophy of Science at the University of Melbourne.

She is a past state president of the Australian Federation of University Women and University College at the University of Melbourne, and was a member of the South Asian and Human Rights caucuses at the 1995 United Nations 4th Conference on Women, held in Beijing. Dr Dumble is a member of the Committee on Women, Population and Environment, coordinated by Professor Betsy Hartmann from Hampshire College, Massachusetts, and of the Amsterdam-based Women's Global Network for Reproductive Rights.

Continued from page 34

If the above passage alluded to a sinister, manipulative arm to the industry, it is because I believe it to be inherent in this field. Interferon, hailed as the new champion in the 1970s, had actually been discovered at least 50 years previously and then shelved. Why turn to it now unless the above were true? Public manipulation and public gullibility are extreme in many areas; cancer, however, leads the field.

STOLEN HOPE

The interferon onslaught was savage. Newspapers, magazines, television and radio programs were at saturation levels with details of miraculous cures. Like a well-oiled machine, the Cancer Institute announced it would commence interferon trials; then, soon after, hospital fundraising events were commenced. This 'dance' of announcing breakthroughs, then a program for implementation followed by appeals for public donation, was monotonous and obvious, year after year.

Many controversial figures have been accused of preying on desperate victims and profiting from false hope. With

decades of failure behind them but excellent marketing and publicity, with daily announcements of breakthroughs and assurances of imminent success, with billions raised within this format, could the cancer industry not also be accused of the same? Yesterday's heroes fade into oblivion and new hopeful contenders are found to blaze in glory for a time, then fail. They may fail in living up to therapeutic expectation but always succeed in maintaining the illusion of dynamic progress and in raising phenomenal income.

Interferon was showing initial remarkable activity in several cancer types; most importantly, and repeatedly, cases of advanced multiple myeloma were shown recovering with this new therapy. My father's hospital had announced that it would investigate its efficacy in the treatment of multiple myeloma. A dream come true, a hope reignited!

My father was a doctor. He had worked at the Peter McCallum Cancer Institute and was on first-name basis with most of the specialists there. He was also one of few long-term survivors of multiple myeloma at that hospital, so surely he would be one of those enrolled in the trial now that all other

therapies were failing him.

Reality hardly ever fulfils all your dreams and prayers. It is also not usually as needlessly cruel as it was to my father. Following months of anticipation and planning into what had seemed a bleak future, we awaited notification of the interferon trial. My father was not accepted.

In medical trials, patient selection is often optimised for demonstrating good results. The healthier the patient, the more likely they are to survive the trial (no point investing in someone who may die prior to accumulation of data), and the more likely they are to make the product look good. My father was a risk. Death loomed closer; cancer laughed and marched on, its progress accelerated by a weary body and a spirit shattered not by disease but by hope that was taken away.

Editor's Note:

We will continue this story next issue with detailed coverage of Dr Sam Chachoua's Induced Remission Therapy.

VIDEOS AVAILABLE:

Two videos on Dr Chachoua's work are now available. Contact your nearest NEXUS office, or order from the web page: www.peg.apc.org/~nexus/chachoua.html

Continued from page 42

manipulate fertility, gender and even behaviour; and to the readers of the respected *American Teacher* (71[6]:16, March 1987), who were gullible and naïve enough to believe the account of H. Wohlfrath of the University of Alberta, Canada, who in 1982 replicated the nearly 50-year-old work of Soviet researcher E. I. Kritvitskya, in which high-frequency-restored classroom light reduced absenteeism, eye strain, dental caries, etc. as it increased attention, retention, etc.

When Dr Sy expressed his "disbelief" in 1931, he could do so with a certain innocent honesty. But would the editors of *CJC* have us dismiss vol. 453 (1985) of the *Annals of the New York Academies of the Sciences*, on "The Medical and Biological Effects of Light" (an entire conference on the subject) as so much chopped liver? Or was the then nine-year-old *Annals* too recent to have come to the attention of the *CJC* editors, or too old for their consideration? Unlike Dr Sy, they are at least guilty of criminal paucity of scholarship.

Responding to this anonymous *CJC* article, Dr Steve Ross, writing in the WRF

International Health and Environment Network Journal, *World Research News* (2nd quarter 1995), goes succinctly to the core:

"The *Cancer Journal for Clinicians* is sent to virtually all the physicians in the United States dealing with cancer. Could this sort of stupidity and misinformation be one of the reasons why the answer to the cancer problem has not come as quickly as suspected?

"During the Inquisition, individuals were burnt at the stake for believing that the Earth revolved around the Sun. The same Inquisition takes place today when the bastion of the medical community persecutes and removes those individuals who attempt to discuss and utilize therapies that are different than the therapeutic system that is being touted by the pharmaceutical industry."

In all fairness to Fishbein, he did not create the Torquemada mentality—a mindset untroubled by the subtle (or not so subtle) distinction and easy interchangeability between a science of data and a science of dicta. After all, the *JAMA* before, during and after Fishbein was never the arena to

seek the open Lockean dialogue in "the free marketplace of ideas" in which truth would always emerge as the best value. Ridicule as retort and censure by consensus pre-date even Galileo. It could be argued that all this is part of our collective hardwiring.

The real and ongoing legacy of Fishbein—the apotheosis of the peer review, the institutionalisation (professional, academic, corporate and political) of entities that perpetuate and fuel the reactionary, counter-evolutionary potentials of the human intellect—is not a simple, single bequest. It is rather an annuity that pays out incrementally in pain, indefinitely.

Today, a century and a quarter after Dr Babbitt and 100 years after Dinshah's empirical confirmation, in modern Western-style hospitals all over the world you will find the seriously traumatised post-surgical patient routinely maintained under the arbitrarily bizarre and randomly unbalanced spectra from cool and allegedly "white" fluorescence, while meticulously sustained on FDA-determined *minimum* daily nutritive requirements. You may *sneak in* a full-spectrum light; you may

Continued on page 84

Continued from page 83

sneak in anti-oxidant vitamin megadoses. But here in the United States—the Land of the Litigious where the unholy AMA/FDA annuity is issued—take great care to call the light "*only* cheerful", the co-enzyme pills "*only* food". The operative words are "sneak in" and "only". Otherwise, apprehension constitutes an interference with the conventions of established (hence, ossified) medical practice; and the consequent shifting of criminal, civil and professional responsibilities (especially monetary liabilities) is quicker than 186,270 miles per second in a vacuum.

This confusion, this melding of the professional proclamation with the proof of the pudding, may, in some Hegelian anti-theoretical manner (the "...and one step back" of the historical process), provide some sort of intellectual brake to the evolutionary inevitable. However, as bleak a picture as this is, the flip side of the Hegelian paradigm promises a net gain of one forward step. This could be the philosophical principle that makes Dinshah's motto about defeated truth remaining unconquerable, a feature of the universe rather than mere

personal mantric expedient.

At any rate, the work of Dinshah P. Ghadiali, the light of spectrochromology and related phototherapies, although deliberately dimmed for decades has not been extinguished. In fact, SCT endures and modestly thrives under the diligent, dedicated tutelage of Dinshah's son, Darius Dinshah—the accessible and gentle prime-mover for the active work being continued by the Dinshah Health Society.

The Society serves as an active information-clearing centre, holding annual meetings, publishing a newsletter and archiving relevant literature available to an increasingly interested public. Especially recommended, both for historical background as well as for its simple, utilitarian instructional material, is Darius Dinshah's book, *Let There Be Light*.

Note:

The Dinshah Health Society is a non-profit, scientific, educational, membership-based corporation. For further information, contact the Society at: PO Box 707, Malaga, NJ 08328, USA; telephone +1 (609) 692 4686; web: <http://www.wj.net/dinshah>

About the Author:

Stuart Troy, a native of New York City, is a researcher and writer. His first foray into print was in 1978 with a critical article, "Sigmund Freud and the Relevance of a Newtonian Scientist in the Post-Einsteinian/Heisenberg Age", for *APERION: A Journal of Philosophical Inquiry and Opinion*, for which he was also an associate editor. His first book, co-authored with Jonathan Eisen, was *The Nobel Reader* (Clarkson N. Potter, NY, 1987). His Dinshah article is also included in *Suppressed Inventions II* (edited by Eisen, published in late 1997 by Avery Books, Garden City, NY, USA).

Stuart is currently working with noted historian Monroe Rosenthal on a history of women warriors of the Jews. His other driving passion is the preparation of a detailed report on the various iniquitous activities of Dr (*sic*) Morris Fishbein, and he requests NEXUS readers with any documentary or anecdotal material on Fishbein to communicate with him care of PO Box 5027, Fort Lauderdale, Florida 33310, USA, or e-mail him care of: bick@earthling.net.