

NEXUS

NEW TIMES MAGAZINE

Volume 4, Number 1 DECEMBER 1996 - JANUARY 1997

PO Box 30, Mapleton Qld 4560, Australia

CONTENTS

LETTERS TO THE EDITOR.....	4	NEW SCIENCE NEWS.....	50
GLOBAL NEWS.....	6	<i>A selection of interesting news and views from the underground science network. This issue, recent Indian research into ancient alloys, plus a sampling of 'suppressed' energy-efficient devices.</i>	
<i>A round-up of the news you probably did not see.</i>		THE POLTERGEIST MACHINE.....	55
THE ESP OF ESPIONAGE—Part 2.....	11	<i>By Albert Budden. The Hutchison device proves that poltergeist-type effects can be created in the laboratory. Indeed, many paranormal displays could be the result of electromagnetic anomalies.</i>	
<i>By Turan Rifat. For decades the American and Russian military have been competing to develop advanced techniques in telepathy and telekinesis, but we don't have to be victims in their mind wars!</i>		THE TWILIGHT ZONE.....	62
POLLUTED PET FOOD: THE SHOCKING TRUTH!....	17	<i>Strange tales from around/within/off the world. Here, Robert Goodman describes the high-tech weapons of ancient India; and the healing miracles of Charo Alvarez, using special stones and sea water.</i>	
<i>Contributions from Earth Island Journal. When you realise that commercial pet food contains domestic dogs and cats, plastics and environmental toxins, you'll never again feed it to your cherished pets!</i>		NATIVE ELDERS REVEAL ET CONTACTS.....	67
MAJOR JORDAN'S DIARIES—Part 1.....	23	<i>By Richard J. Boylan. Tribal leaders have decided that now is the time to share the wisdom of the Star People amongst the Four Nations of Earth.</i>	
<i>By Major George R. Jordan. This excerpt from a rare, 1952-published diary reveals that, from 1942, the USA secretly siphoned to the USSR the raw materials, technology and know-how for making atomic bombs. So, was the Cold War a cruel hoax?</i>		REVIEWS—Books.....	71
THE 'OCTOPUS' CONSPIRATORS—Part 2.....	31	<i>"NASA, NAZIS & JFK: The Torbitt Document" intr. by Kenn Thomas</i>	
<i>By Kenn Thomas. During his Inslaw investigations, Danny Casolaro identified a shadowy network with a subversive global agenda. He was not the first to be strangled by the tentacles of 'the Octopus'.</i>		<i>"From the Ashes of Angels" by Andrew Collins</i>	
COLLOIDAL SILVER: A UNIVERSAL GERMICIDE.....	39	<i>"The Great Book of Hemp" by Rowan Robinson</i>	
<i>A compilation. Studies show colloidal silver kills all known disease-causing organisms in minutes. With its germicidal properties and negligible toxic side-effects, no first-aid kit should be without it!</i>		<i>"Top Secret/Majic" by Stanton T. Friedman</i>	
SOUND TREATMENTS FOR GOOD HEALTH.....	45	<i>"Bloodline of the Holy Grail" by Laurence Gardner</i>	
<i>By Alix Kirsta and Tom Kenyon. The quality of sound affects us in different ways. Here we feature the Tomatis Method for improving communication skills using sound frequencies, and Tom Kenyon's research into the science of mantra, or chanting.</i>		<i>"The Riddle of the Pacific" by John Macmillan Brown</i>	
		<i>"Who's Who of the Elite" by Robert Gaylon Ross, Sr</i>	
		<i>"Contacts with the Gods from Space" by George King, DD, ThD</i>	
		<i>"Emerging Viruses: AIDS & Ebola..." by Dr Leonard G. Horowitz</i>	
		<i>"Smuggled-2" by Raymond Hoser</i>	
		<i>"Conspiracies, Cover-ups & Crimes" by Jonathan Vankin</i>	
		<i>"Gods of the New Millennium" by Alan F. Alford</i>	
		<i>"Rumors of Existence" by Matthew A. Bille</i>	
		<i>"The Dark Side of Christian History" by Helen Ellerbe</i>	
		<i>"You Can Have Your Permaculture..." by Robin Clayfield</i>	
		<i>"What in the World is Going on Here?" by Coburn Tuller</i>	
		<i>"Q' Mechanics" by Terry J. Skrinjar & Steven T. Walker</i>	
		REVIEWS—Audio.....	79
		<i>"The Music of the Grand Canyon" by Nicholas Gunn</i>	
		<i>"Afro-Desia" by Steven Halpern & Suru</i>	
		<i>"Olé, Olé" by Rachid Taha</i>	
		<i>"The Half Tail" by Wolfstone</i>	
		<i>"Mickey Hart's Mystery Box" with Mickey Hart</i>	
		NEXUS BOOKS, SUBS, ADS & VIDEOS.....	90

NEXUS MAGAZINE

Volume 4, Number 1

DECEMBER 1996 - JANUARY 1997

PUBLISHED BY

NEXUS Magazine Pty Ltd, ACN #003 611 434

EDITOR

Duncan M. Roads

CO-EDITOR

Catherine Simons

ASSISTANT EDITOR

Ruth Parnell

EDITORS' ASSISTANT

Richard Giles

OFFICE ADMINISTRATOR

Janine Carmichael

CONTRIBUTORS THIS ISSUE

Norman Solomon, Turan Rifat,

Earth Island Journal, Major George R. Jordan,

Kenn Thomas, Alix Kirsta, Tom Kenyon,

Robert Goodman, Byron S. Wine III,

Albert Budden, Richard J. Boylan

LAYOUT & DESIGN

Duncan M. Roads

CARTOONS

Phil Somerville

COVER GRAPHIC

Don Landwehr/The Image Bank

PRINTING

Warwick Daily News, Queensland, Australia

AUSTRALIAN DISTRIBUTION

Newsagents Direct Distribution

HEAD OFFICE - All Correspondence

PO Box 30, Mapleton, Qld 4560, Australia.

Ph: +61 (0)7 5442 9280; Fax: +61 (0)7 5442 9381

e-mail address: nexus@peg.apc.org

web page: <http://www.peg.apc.org/~nexus/>

NEW ZEALAND OFFICE - PO Box 34735,

Birkenhead, Auckland. Ph: +64 (0)9 416 7320;

Fax: +64 (0)9 416 7340

USA OFFICE - PO Box 177, Kempton, IL 60946-

0177. Ph: (815) 253 6464; Fax: (815) 253 6454

UK OFFICE - 55 Queens Rd, East Grinstead, West

Sussex, RH19 1BG. Ph: +44 (0)1342 322854;

Fax: +44 (0)1342 324574

EUROPE OFFICE - PO Box 372, 8250 AJ Dronten,

The Netherlands. Ph: +31 (0)321 380558;

Fax: +31 (0)321 318892

ITALY OFFICE - c/- Avalon Edizioni, Piazza

Mazzini 52, 35137 Padova.

Ph/Fax: +39 (0)49 912 6006

STATEMENT OF PURPOSE

NEXUS recognises that humanity is undergoing a massive transformation. With this in mind,

NEXUS seeks to provide 'hard-to-get' information so as to assist people through these changes.

NEXUS is not linked to any religious, philosophical or political ideology or organisation.

PERMISSION-TO-REPRODUCE POLICY

While reproduction and dissemination of the information in NEXUS is actively encouraged, anyone caught making a buck out of it, without our express permission, will be in trouble when we catch them!

Editorial

What a past two months it has been! Since producing the last issue, Catherine and I have been overseas to visit our NEXUS offices in the USA, Netherlands and the UK. We also managed to pop into Germany for a day to arrange for the German edition of NEXUS to go into production in March 1997. Upon our return, I attended to all the 'incomings', and then we took off for the International UFO Expo in Brisbane, followed by a trade fair in Melbourne, then a trade fair in Brisbane again, but we still got back in time to produce this issue!

I might pause for breath here and say that the UFO Expo in Brisbane was great! Over 500 people from all over the world came each day to contribute to a memorable experience. Our congratulations to the organiser, Glennys Mackay, and her team of helpers.

Tomorrow we are off to the Mind Body Spirit Festival in Sydney for a week, and soon after we return we intend to take a well-earned holiday!

Despite our time away, we have again found some great articles and information for this issue.

My personal favourite this issue is "Major Jordan's Diaries". This is a truly incredible account, as I'm sure you will agree. It sure puts a new spin on the Cold War. Stay tuned for an explosive Part 2!

The article last issue on "The ESP of Espionage" attracted a lot of attention. The author has told me that he believes British Intelligence is onto him, so if you don't get to read Part 3 in the next edition, you'll know why!

We've put together a selection of articles on "Polluted Pet Foods"—or, in some cases, "Pets in Your Food". I guarantee you will never look at commercial pet food the same way again!

We have had so many people ring to ask us about Colloidal Silver that I just had to compile an 'editor's choice' from all the Internet info. As usual, I'd be happy to have feedback on results from readers using it.

Some articles sit in our various in-trays a long time. Such was the case with our folder on "Sound Therapy". I had never really 'dived' into this before, but when I did I was amazed! I'm sure you will also be impressed by the information in these articles. In fact, just reading them has already influenced my office listening-habits. Usually I put on the local radio, but lately I'm listening to—dare I say it—classical music! I'm already noticing that I can concentrate better and that I feel more relaxed at work.

The article entitled "The Poltergeist Machine" should give many people food for thought. The machine mentioned by the author can artificially generate incredible poltergeist-like effects, and it may one day open up new horizons for scientific research.

Richard Boylan's round-up of what various Native Elders from around the planet had to say about their contact with extraterrestrials is also very illuminating. It appears that many tribes feel that they can now reveal secrets they have kept from the world about their ET visitors. As you will read, all of these Native Elders believe that we are entering times of great change, including massive Earth changes, the return of our ET visitors, etc.

On a different note, all of us here at NEXUS wish all our readers a very happy and fulfilling festive season.

Duncan

WARRANTY AND INDEMNITY

Advertisers upon and by lodging material with the Publisher for publication or authorising or approving of the publication of any material INDEMNIFY the Publisher and its servants and agents against all liability claims or proceedings whatsoever arising from the publication and without limiting the generality of the foregoing to indemnify each of them in relation to defamation, slander of title, breach of copyright, infringement of trademarks or names of publication titles, unfair competition or trade practices, royalties or violation of rights or privacy AND WARRANT that the material complies with all relevant laws and regulations and that its publication will not give rise to any rights against or liabilities in the Publisher, its servants or agents and in particular that nothing therein is capable of being misleading or deceptive or otherwise in breach of the Part V of the Trade Practices Act 1974. All expressions of opinion are published on the basis that they are not to be regarded as expressing the opinion of the Publisher or its servants or agents. Editorial advice is not specific and readers are advised to seek professional help for individual problems.

© NEXUS New Times 1996/1997

Letters to the Editor ...

Remote Reconnaissance

Dear Duncan: I read the article "Remote Viewing—the ESP of Espionage" (NEXUS Oct-Nov '96, vol. 3, no. 6) with great interest.

I recollected that, back in the late '60s I interviewed a UFO witness who had been an officer in the Kings West African Rifles. After discussing his UFO report, he went on to recount that as an officer in the KWAR he had been in charge of a unit on a lonely base in West Africa. They were supplied each week by a ration wagon which arrived on a Tuesday.

On one particular Tuesday, the ration wagon did not turn up and the officer discussed the situation with his black African sergeant. The African sergeant then told the officer that he would try and locate the missing truck, and he then went into a trance-like state. This lasted only a few minutes and then the sergeant returned to normality, stating that the ration lorry had gone off the road and into a ditch about twelve miles from their camp. The officer and the sergeant then jumped into a Jeep and drove twelve miles to the predicted spot: there was the lorry, stuck in the ditch!

I never forgot that story which was related to me long before the mention of such things as 'remote viewing'.

Regards, Omar Fowler, Phenomenon Research Assoc. (Derby) England; Director, *Flying Saucer Review Magazine*.

Remote Possibilities

Dear Duncan: Firstly I would like to express my deepest gratitude for the existence of NEXUS Magazine, and both the inspiration and encouragement that it offers in our daily lives.

Secondly, I would like to thank you for publishing the article on Remote Viewing (vol. 3, no. 6) by Turan Rifat. The part which dealt with describing how the public could learn to use these paranormal abilities to 'return the favour' to those who take extreme delight in prying into our lives, was particularly enlightening, inspirational and also amusing!

For those who'd be interested in knowing, the remote viewer Joseph McMoneagle will soon be releasing his next book, tentatively titled *Expectations from the Year*

3000. This one is promised to be quite riveting!

To find out more, write to: The Monroe Institute, Route 1, Box 175, Faber, Virginia 22938-9749, USA. They will be changing their address soon, so I hope that this one still holds.

Yours sincerely, Justin M., Annerley, Qld, Australia.

Healthy Right to Know

Dear Duncan: In the three years I have been reading NEXUS, I have been amazed and awed by all the information. I think the term is "gob-smacked".

I have taken the appropriate steps to try and protect my family's health as best I can.

But what about the rest of Australia? Don't they have a right and a need to know as well?

The authors of stories on issues such as fluoridation, mercury-amalgam fillings, unleaded petrol and the dangers of pasteurised milk should be saturating the airwaves with their knowledge, be it on *60 Minutes* or *A Current Affair*, or storming the corridors of Parliament until someone took some notice. Our health and well-being depend on it. I look forward to your response.

Dorothy A., Edge Hill, Qld.

Alien Autopsy Film not Faked!

Dear Mr Roads: Interesting! That's the second article I've read recently which goes against the usual flow and suggests that the autopsy film could be genuine. The other article, "Autopsy Hoax? Prove it!" by Eris Andys, appeared in issue no. 4 of *Sightings Magazine*, published by Rapide of Newton Abbot, Devon, UK.

I shall be very interested in viewing the rest of the film if, and when, it comes on general public release. If the film can be proved to have come from 1947 stock (or at least from the 1967 stock, with the added statement that it could not have been used after 1970 because it would have deteriorated), and if there is another viewable autopsy with at least one more alien body, then I feel it should be given the benefit of the doubt. Who, even as late as 1970, could have produced such a clever fake? And supposing, by some miracle, such incredible fakes could have been created, why

weren't they made more in the fashion of what aliens are, by all accounts, supposed to look like? Whoever's heard of six-fingered aliens up to now? And then there is the question of why, in the late '60s, anyone should want to make a fake alien autopsy. Roswell didn't resurface until the early '70s and abductions were thin on the ground (or in the air) until the '80s.

When you take the whole thing to pieces, a fake makes no sense at all. To my mind, given the two provisos above, Michael Hesemann's suggestion that the autopsy is on an alien from a crash at Socorro does make sense.

Sincerely, Sonya P., Woking, Surrey, England, UK.

Smart Surveillance? No ID!

Dear Duncan: Why did you not put the two Global News items, "Soul Catcher Implants" and "Secret Implants Illegally Used On Prisoners" on the same page spread? (NEXUS, vol. 3, no. 6).

For we read that with the BT 2025, "...police would be able to use it to relive an attack, rape or murder from the victim's viewpoint, to help catch the criminal...", while the IBM 2020 can "...make the unsuspecting prisoner a walking, talking tape recorder of every event he comes into contact with." The tracking devices of the Thought Police!

It is, of course, complete trash; after all, we have just viewed Agent Scully (of TV show, *The X-Files*) have such a device removed from the back of her neck. And we all know that TV is make-believe! Well, we do, don't we? Just look how big a 'chip' is! Actually, it is minute: 1 or 2 mm square!

It really amazes me that so much technology now is what I read about in sci-fi mags over 10 years ago. All is coming true now, especially the remote mass-surveillance part.

Take your 'smart' credit card (or, rather, bin it!). This is a very small device which, upon a given electromagnetic field, will spew all sorts of data about you held on the card. And do not believe that you have to put it into a machine: just passing close to a sensor device will do. Hence the demand for the 'smart' ID card. Don't leave home without one: you won't get very far!

In a word, all this surveillance is perpetrated by some people who are paranoid—severely mentally ill. And they have most of the money and, they think, the power. But what happens when they own *all* the money? We use LETS, or some other system, and money becomes redundant.

Here is an American Cree Indian Prophecy:

"Only after the last tree has been cut down/ Only after the last fish has been caught/ Only after the last river has been poisoned/ Only then will you realise that money cannot be eaten."

Maybe these last four lines should be put onto every financial institution's and international company's e-mail or web site worldwide.

Regards, Alan L., Glastonbury, Somerset, England, UK.

Pining for Pine Gap Info

Dear Duncan: One of your readers (Letters, vol. 3, no. 6) asked about Pine Gap, which is a US geostationary signals intelligence satellite base. The two best books that I have found about this base are *Pine Gap* by Prof. Desmond Ball (Allen & Unwin, 1988, ISBN 0-04-303002-5), and *The Ties That Bind* by Prof. Desmond Ball and Dr Jeffrey T. Richelson (Unwin Hyman, 1990, 2ed., ISBN 0-04-520009-2).

When he wrote these books Prof. Ball was the head of the Strategic & Defence Studies Centre at the Australian National University. Both books are full of information; however, the second is more interesting because it details intelligence-gathering cooperation between the UKUSA treaty partners throughout the world.

Neither book mentions the rumour that Pine Gap has something to do with UFOs. In my opinion the US early-warning satellite base at Nurrungar in South Australia is probably used to track UFOs on this side of the planet.

Yours sincerely, Simon H.-W., Mundaring, Western Australia.

A Matter of Gravity

Dear NEXUS Person: I am writing to thank you for reviewing a book called *Gravitational Force of the Sun*, by Dr Pari Spolter, in NEXUS, June-July 96 (vol. 3, no.

... more Letters to the Editor

NB: Please keep letters to approx. 100-150 words in length. Ed.

4). I bought the book to find out how to calculate the gravitational force of celestial bodies, for a project I'm working on, thinking it would be a well-understood and thoroughly documented area of research beyond controversy—more fool I!

Dr Spolter exposes the fundamental mathematical errors in both Einsteinian and Newtonian theory with such elegance and ease that even a mathematical recalcitrant like myself was inspired to recall my high-school mathematics (last used in anger 20 years ago!) to follow her working out. No, I am not making this up: I voluntarily engaged in strenuous mathematics for my own enjoyment!

Gravitational Force of the Sun is very focused. Dr Spolter successfully knocks the pins from under two great, unchallenged theories of science by reviewing the original documents that Newton wrote and examining the mathematics and assumptions that Einstein and Newton used. I have seldom before read a more thorough hatchet job. She must be a relentless researcher with a prodigious memory and intellect.

The book is not negative. Dr Spolter shows Kepler's contributions to be far greater than I previously suspected (Kepler's work is the foundation she builds her work on), and what she tears down she rebuilds.

With this book I can go forward in my project: without it I would be doomed to failure. Thank you, Dr Spolter, and thank you, NEXUS.

Regards, Paul M., Sydney, NSW, Australia.

Reviews Under Review

Dear Duncan: Why is every book and video reviewed in your magazine always praised and never criticised? Do New Age writers and artists always produce flawless work?

Yours enquiringly, John F., Southampton, England, UK.

(Dear John: *The reason we usually do positive reviews of books, tapes and videos in NEXUS is because we select items for review that we feel deserve positive attention. Rather than write a negative review of someone's work, we tend not to review it at all. What is achieved by criticising someone else's work, anyway?* Ed.)

Health Consumers Unite!

Dear Duncan: With an ever-growing number of Australians paying personally for natural therapies, rather than accepting Medicare-funded, drug-based medicine while still paying their Medicare levy, it was only a matter of time before these consumers called for a 'fair go'.

A group of consumers, disenfranchised with the inequalities of the current unrepresentative healthcare system, has launched the Australian Healthcare Consumers Association (AHCA) to address this discrimination, advocating equal and informed healthcare choices for all Australians.

The AHCA claims that many more Australians would choose natural therapies if they were available under Medicare, and even in greater numbers if they were aware of the numerous and valid low-cost, drug-free alternatives that have been withheld from them by overzealous medical authorities.

With Australia overdosing on antibiotics, and the high cost of drugs and surgery crippling the system, the acceptance of natural therapies in our healthcare systems would result in significant savings to governments and consumers by reducing the use of many expensive drugs and questionable surgical procedures.

American health insurance experience indicates significant savings can be made when patients are given a choice of combined natural therapy and conventional medicine.

Healthcare systems across the nation are in chaos, with claims and counter-claims being made by doctors and politicians over lack of services in cities and the country, and a multitude of healthcare workers airing their views in the media, *with no one bothering to ask the healthcare consumer what they want!*

Consumers want a multi-disciplined system, combining the 'best practices' of all, including allopathic medicine, complementary medicine, alternative and natural therapies, incorporated into one excellent healthcare system according to the level of consumer preference.

Now at last there is an advocacy group representing the con-

sumers' interests, which is prepared to challenge the AMA's, health department bureaucrats' and politicians' right to dictate conventional medicine as the only solution, when it is patently obvious that conventional medicine does not have all the answers.

If your readers support the case for an equal and informed healthcare choice, they are invited to join AHCA now.

Write to: PO Box 2310, Port Macquarie, NSW 2444, phone (065) 56 3264, fax (065) 56 3080.

Yours sincerely, Max Hamilton, Convenor, AHCA.

Gun Laws Gone Wrong!

Dear Editor: There is going to be a tremendous number of angry Australian citizens when they discover how they have been betrayed and deceived by our politicians and the media who always deny and ridicule any accusations that there are any conspiracies against the citizens.

The Prime Minister, Attorney-General, supporting politicians and the media have all stated that these new national disarmament laws cannot prevent another massacre or even restrict criminals' access to guns. But they do claim that the laws will make Australia safer and will save us from going down the 'American path'.

Well, this is not so, according to a recent article in *Security Australia* magazine, by Police Sergeant Kenneth May, a graduate of the FBI in the USA. In his article, "The American Path: A View of Australian Gun Control", he states that he expects our crime rate to rise as it has in all major states and cities of America where similar strict gun-control laws have been enforced.

In Washington, for example, which totally disallows firearm ownership under its Bartley Fox Act (1950), there is now a homicide rate of 75 per 100,000. This is exceeded only by South Africa, with a homicide rate of 87 per 100,000. The American average is only 9 per 100,000, and in the 31 states which have now legislated for the right of approved citizens to carry concealed pistols, and with only 5% being armed, the crime rates in these states have dropped. In Israel, where everybody is armed, the homicide rate is 2 per 100,000 and, in Switzerland, almost nil despite

everybody having a gun!

Sergeant May concludes that the Australian Government is taking us down the American path, and that path is the failed experiment called "Gun Control".

Yours faithfully, Bob Doring, Mooloolah Valley, Qld, Australia.

Naval Gazing at UFOs

Dear Duncan: I spoke to you briefly by telephone in Sydney in 1994. I mentioned a conversation I had with Stan Deyo and his ongoing relationship with Bill Cooper. At that stage I was well-versed with Valdemar Valerian's epic *Matrix 3*.

During this period I ironically stumbled across a gentleman with whom I developed a special relationship. This particular person (after a period) took me into his confidence and exposed me to some interesting material. I might add that only the verification of his identity was based on an invitation to his home in the company of his wife. Moreover, there were photographs about the place with the particular gent in naval military uniform. He claimed he had at the time a security clearance level which was regarded as highly sensitive: his function with the Navy was in "air-to-surface radar facility" on the HMAS *Perth*!

During the invasion of Afghanistan by the Russians in the late 1970s, the world military apparatus was put on red alert. He stated to me that the ship's highly sophisticated radar equipment observed UFO activity over that particular air space. He described this kind of activity as "hot spots".

Of course I questioned him as to whether this manifestation was a blight of some description. He stated that the objects were in fact real mass, that they were non-conventional aircraft that were over-seeing activity in this so-called "hot spot". He claimed on two occasions there were between eight and twelve autonomous aircraft manoeuvring at velocities which defied our understanding of conventional aircraft manoeuvrability. He retired from the Navy in the early 1980s and has pursued a similar, but much lower profile as Bill Cooper.

I thought this material may interest some of your readers.

Regards, Shane S., Daylesford, Victoria, Australia.

BANKING ON CONTROL

If the American people ever allow private banks to control the issue of currency, first by inflation, then by deflation, the banks and the corporations that will grow up around them will deprive the people of all property until their children wake up homeless on the continent their fathers conquered. — Thomas Jefferson

The real truth of the matter is...that a financial element in the large centers has owned the government of the US since the days of Andrew Jackson.

— Franklin D. Roosevelt

Every effort has been made by the Federal Reserve Board to conceal its powers, but the truth is...the Federal Reserve System has usurped the government. It controls everything here [Congress] and it controls all our foreign relations. It makes and breaks governments at will.

— Louis T. McFadden, ex-Chair, House Committee on Banking and Currency

CIA REMOTE-VIEWING REPORT

There is a CIA research report on "remote viewing", "psychic abilities" and "apport phenomena", dated 3 August 1964. It is designated as Information Report 00-B321-02171-64.

I've asked the CIA for a copy, but was



told that it is classified national security information and cannot be declassified. I believe that it is not currently and properly classified, but they have not reviewed it adequately for possible declassification because they have not even released the title page. If several dozen people ask for a copy, perhaps they will rethink their analysis on this document which, after all, is more than 32 years old.

If you are interested, just send a simple letter requesting a copy of Information Report 00-B321-02171-64, under the Freedom of Information Act, to:

Central Intelligence Agency
Information & Privacy Coordinator

Washington, DC 20505, USA.

Tell them that you would like all segregable portions of the document that can be declassified—even the title page.

(Source: Michael Ravnitzky,
MikeRav@ix.netcom.com)

FIRST OFFICIAL ALTERNATIVE MEDICINE CLINICS OPEN IN USA AND CANADA

The King County Natural Medicine Clinic, the first federally funded clinical facility in the United States offering complementary alternative medicine as a primary care option, opened its doors in Kent, Washington state, on 21st October 1996.

Bastyr University in Seattle, an accredited institution of naturopathic and natural medicine, was chosen last July to be the lead agency to operate the clinic. Funded at a level of US\$750,000 in its first year, the clinic is being watched very closely by policy-makers and the media and will serve as a national model for future government-funded natural medicine clinics.

The establishment of the Natural Medicine Clinic, and the decision of the Washington state legislature and Office of Insurance Commissioner Deborah Senn in 1995 to require insurance companies in the state to cover licensed practitioners of alternative medicine, have catapulted Washington state into the forefront of the growing national movement to legitimise and make more widely available myriad credible, complementary alternative medical options.

In Canada, British Columbia's largest hospital has established the Tzu Chi Institute for Complementary and Alternative Medicine, an ambitious project aimed at integrating Western medicine with the traditional therapies of Asia.

"The mainstream health care system can't hide in a hole and pretend these alternatives don't exist," said Vancouver Hospital's President, Murray Martin. "Alternative medicine is everywhere."

The project is being initially funded by a generous endowment from the Tzu Chi Foundation, a Buddhist charity organisation based in Taiwan.

(Source: Peter B. Chowka and Michael S. Evers, Natural Health Village, <http://www.netvillage.com/>)

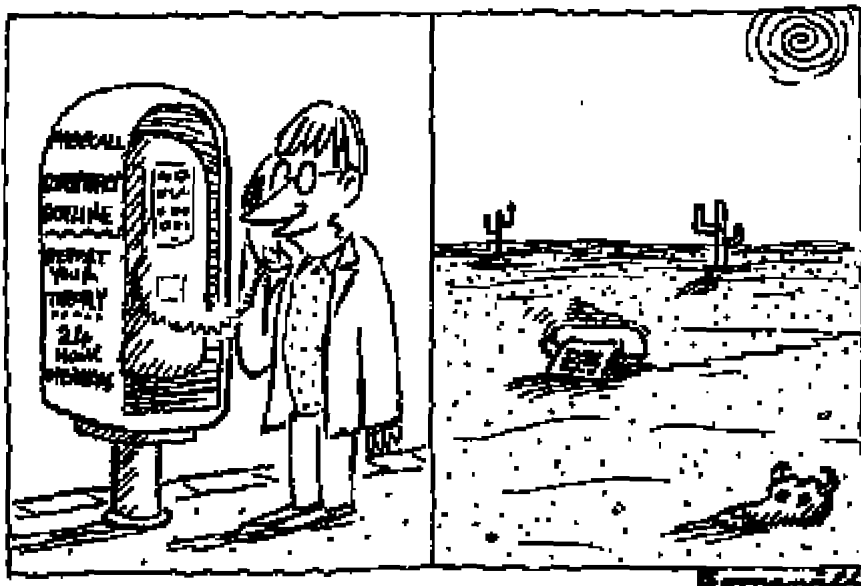

DID US GOVERNMENT KNOW OF OKLAHOMA BOMBING IN ADVANCE?

• The Portland newspaper the *Oregonian* (20 April '95) stated that Judge Wayne Alley, whose office is right across from the Murrah building, was warned several days prior to the blast by "security specialists" to take "special precautions". This story has never resurfaced.

• *USA Today* (20 April '95) reported that Harvy Weathers, of the Oklahoma City Fire Department, said that the fire department had received a call from the FBI prior to the bombing, stating that there would be "some people entering the city over the weekend". Weathers did not explain what this meant, but obviously an army of FBI were to enter the city, at least after the bombing later the next week, to destroy and fabricate evidence. So the question is, how did the FBI know this beforehand?

• Oklahoma State Representative Charles Key has said that he knows of two witnesses who overheard ATF employees state that they were warned *not* to come to work that day. Key also points out that bomb squad employees were seen in front of the building at 7.15 am, about two hours prior to the blast. Rep. Key has conducted his own investigation and was so shocked with the evidence he uncovered that he has compiled it into a video presentation.

• The McVeigh defence team is in possession of tapes of a call made by the FBI, several days prior to the 19 April '95 blast, to Oklahoma City officials warning of a possible terrorist event in the next few days. This was reported by the Associated Press. (As much as a try to save everything, alas, I failed to save this AP report, but I assure you it exists and I'll find it as soon as I can find access to an AP article archive, or if we hear about it again.)

• That bombs were found inside the building, while largely unknown, is no secret. It was reported widely on CNN and local news broadcasts on the day of the blast. Rescue operations were called off each time a bomb was found (i.e., up to four times), and Army bomb-disposal units worked to defuse the bombs. The bombs were found by bomb-sniffing dogs, which indicates that the bombs contained explosive material.

• KFOR-TV in Oklahoma City reported that two or more of the bombs found inside were "far larger in magnitude than the first that went off inside the building" (remem-

ber that seismic readings measured two blasts). A terrorist expert, Dr Randall Heather, then spoke, saying, "We have both of the bombs that were defused at the site and they are being taken apart."

One must assume, however, that these bombs were eventually misplaced by the FBI, as is common. The news coverage went on to say that another bomb was found strapped to a column next to the day-care centre.

It is important to note that such a column-strapped bomb is consistent with the blast pattern damage seen, which Brigadier General Partin, one of the top munitions experts in the world, says is *not* consistent with an ANFO truck bomb. He says that demolition charges had to be placed on the columns—and, sure enough, one was found that failed to go off.

But, like all these bombs, they just seemed to disappear into oblivion along with any continuing media reports or serious enquiries about these bombs. We are to believe that the building was gutted by a lone nut with a magic ANFO bomb—case closed!

(Source: Ian Goddard,
igoddard@erols.com
<http://www.erols.com/igoddard>)

TV NEWS MEDIA ON TRIAL

Germans are horrified to learn they have been duped by television news programs. Michael Born, a television reporter, and his assistants are on trial, charged with forging 21 television reports and defrauding some

of Germany's most popular television news magazines of about US\$250,000. Episodes depicting hunting, the Ku Klux Klan, and even war were all made with friends and paid actors. "Born is not alone in the dock," said a media expert. "There is no way that he got away with it for so long without his bosses turning a blind eye. The pictures were too good to be turned down."

One of his 'exclusives' was footage of cats being hunted for their fur in Bavaria. A friend of Born posed as a cat hunter. He was filmed shooting a cat acquired from an animal refuge a few days earlier. Another faked 'scoop' featured drug-users licking 'addictive' glandular juices off the back of toads. Yet another was supposed to have depicted fighting along the Greek-Albanian border. Born admits that blood spattered on the ground was tomato ketchup and that the fighters were acting.

But the German TV news reporter didn't stop there. Mr Born had his mother help him sew sheets into Ku Klux Klan robes, and he then filmed actors burning crosses and chanting anti-Semitic slogans.

In the end, Mr Born's success was his downfall. German police began an investigation over the racial incidents. That's when they noticed the same person in two different reports!

(Source: Virginia McMillan,
jinks@u.washington.edu
©1996 by Conservative Consensus,
jinks@u.washington.edu
Newsgroups: usenet.alt.conspiracy,
8 October 1996)



NASA PHOTOGRAPHS HUGE UFO IN SATURN'S RINGS

On 30 January 1996, the Alan Handlemann radio interview program on WRFX-FM, Charlotte, North Carolina, featured a former NACA (National Advisory Committee for Aeronautics, now NASA) scientist, Dr Norman Bergrun, revealing that NASA's *Voyager* space probe took photographs of a cylindrical object, about 1-1/2 Earth diameters long, orbiting in the rings of Saturn. Dr Bergrun said that streamers could actually be seen along the length of the cylindrical object, implying the existence of exhaust ports.

Now, independent confirmation has been published in *Science News* (February 1996, vol. 149, no. 5, p. 71), where the Hubble Space Telescope was reported to have photographed a large, elongated non-satellite orbiting Saturn's rings in one photograph, but which disappeared from a follow-up photograph. Two other very big and very bright orbiting objects were photographed on 22 May '95 and 10 August '95, but they disappeared by 21 November '95.

Dr Bergrun believes that the cylindrical object is intelligently controlled and has attributes qualifying it as a space vehicle. When asked why NASA had not managed to get a photograph of the huge vehicle before, Dr Bergrun said that "they have a tendency to hide in their own exhaust". The former NACA scientist said that exhaust from the length and ends of the vehicle appears as the material constituting the ring.

When asked why NASA and other governmental agencies haven't released this information before, Dr Bergrun answered that the 1958 *Space Act* provides that space data can be withheld if something is found that may constitute a threat—and that a vehicle of this size would be considered a threat and would be deemed to have great military significance. As such, it would fall under the "top black-budget military intelligence agencies".

Dr Bergrun has presented his discoveries in a book, *Ring-Makers of Saturn* (1986), which contains the NASA *Voyager* photograph of this huge space vehicle orbiting in Saturn's rings.

(Source: Richard Boylan, rich.boylan@24stex.com)

COKE & CIGARETTES ARE TOPS AT AUSTRALIAN SUPERMARKETS

Despite tough advertising restrictions, health warnings and falling tobacco consumption, the Marlboro brand of cigarettes has increased its sales value in Australia by 78 per cent over the past year.

The annual brands report, compiled by A. C. Nielsen, ranks Australia's top 100 product names for the past financial year, based on the value of grocery store sales—and if brand names are anything to go by, Australia is a health fanatic's nightmare.

Out of the five best-selling brands in Australian grocery stores, four were cigarettes. Number one position went to Coca-Cola. Number six position went to Nescafé instant coffee; seventh was Pedigree Pal

dog food, followed by Kraft Cheese and Tip Top Bread; and the tenth most-purchased brand was Benson & Hedges cigarettes.

However, the report also revealed that sales of vitamin brands have jumped 1,076 per cent to A\$70million since 1985!

(Sources: *The Sydney Morning Herald*; *The Australian*; 1 November 1996)

UK SURVEILLANCE CAMERAS TO RECORD ALL NUMBERPLATES

Police and security agencies are placing large orders for surveillance cameras that will track the movements of millions of drivers in the UK.

Using sophisticated software, the cameras will read the numberplate of every passing vehicle, and automatically check it against a police database of known or suspected offenders.

As the network expands, it will be possible to find or follow any vehicle in Britain simply by typing in the registration number. The cameras will also be used to detect unregistered vehicles, enforce road laws and monitor traffic congestion.

Starting in spring 1997, Customs-operated cameras at ports will log the numberplates of every vehicle entering the UK.

(Source: *The Sunday Telegraph* [UK], 15 September 1996)

WARNING ON GENETICALLY-MODIFIED FOODS

The first deliveries of American genetically-altered soya 'superbeans' are arriving in UK and Europe amid storms of protest. The soya beans come from soya plants bred by the Monsanto chemical company for resistance to its Roundup herbicide.

Dr John Fagan, a professor of molecular biology from Fairfield, Iowa, has spoken out against such genetically-modified foods, claiming that they are a "significant hazard to public health" and should be withdrawn until tests prove there are no unwelcome side-effects.

Soya beans are particularly under fire, as approximately two-thirds of all British supermarket items, including breads, pastries, vegetable oils, ice cream, chocolate, cereals, margarine and processed meat products, contain soya.

Dr Fagan said: "Introducing a gene into another organism is a Russian roulette process: the position the new gene occupies is not controllable. We are being asked to partake in a nutritional experiment

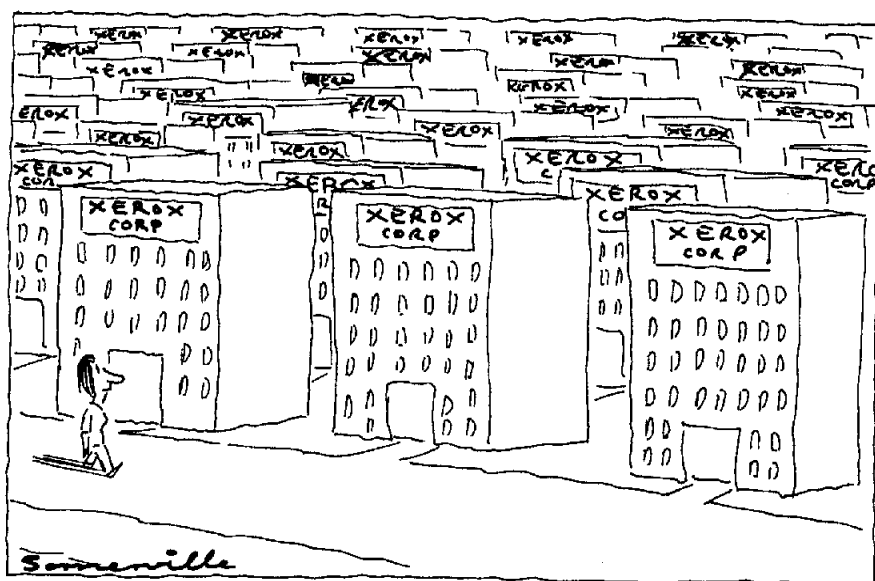

of global proportions."

Under current UK and European laws, genetically-manipulated food does not have to have labelling to state that it is, or contains, a genetically altered foodstuff.

(Source: *The Daily Telegraph* [UK], 7 September 1996)

POLIO VACCINE VIRUS LINKED TO LUNG CANCER

A polio vaccine that was administered to millions of Britons in the 1950s and early 1960s is being linked to a virulent form of lung cancer, following the discovery that it was contaminated by a monkey virus.

Doctors have expressed concern at the latest studies in America which show that the virus, SV40, was found in several tumours.

It is estimated that between 10 million and 30 million Americans were given the contaminated polio vaccine.

The vaccine, cultured from monkey kidney cells, was used in mass vaccinations until 1961. After that, a new vaccine using human cells was developed.

(Sources: *New Scientist*, 24 August 1996; *The Sunday Telegraph* [UK], 1 September 1996)

DOCTORS CLAIM FLU VACCINE CAN CAUSE DIABETES

"After a presentation of our data, we were asked to evaluate the effect of a recent hepatitis B immunisation program in New Zealand on the development of insulin-dependant diabetes. We found a large epidemic of diabetes, 60% increase, occurred in New Zealand following this immunisation program, and believe the most likely explanation is that the immunisation program caused the diabetes epidemic."

These were the words of Dr J. Barthelow Classen, of Classen Immunotherapies Inc. in Baltimore, USA, in a letter to the *New Zealand Medical Journal*.

Dr Classen also warned in his letter:

"Based on this mechanism and our early finding that diabetes epidemics have followed the widespread use of the Haemophilus influenza B vaccine, we expect a second epidemic of diabetes to follow the Haemophilus influenza B immunisation program that was started in New Zealand in 1993/4."

(Sources: *The New Zealand Medical Journal*, 24 May 1996; Vaccination Information Network, PO Box 149, Kaeo, Northland, New Zealand)

WHEN THE NAMELESS SHAPE THE NEWS

by Norman Solomon

Ever wonder who all those "Western diplomats" are? How about the "senior administration officials" and other sources "speaking on condition of anonymity"? If you found an unsigned letter in your mailbox, you'd probably have doubts about the contents. But news stories often include statements by people who dodge identification—yet manage to get quoted and paraphrased with utmost respect.

Those nameless sources are rarely whistleblowers trying to give suppressed facts to the public while avoiding retaliation from their bosses. No, the sources who routinely shape the news are officials eager to promote current policies—but unwilling to stand publicly behind their words.

Early this month [September '96], *Newsweek* reported on "what a senior US official said was one of the largest Iraqi military buildups since 1991". The magazine quoted "a US official" who declared, "We have warned the Iraqis..." When spin doctors want to be anonymous, media outlets are glad to oblige.

As long as government policy-makers can plant and slant news stories while hiding behind nameless façades, they'll do so. And as long as journalists play along, they can claim that it's the only way to get officials to speak on sensitive topics.

Sometimes, unnamed sources say the darnedest and most outrageous things. But, unlike you or I, they won't ever have to answer for what they say.

So, there's still no way to identify the "high-ranking Western diplomat" who made light of political murders supervised by Gen. Augusto Pinochet during the Chilean dictator's 16-year rule. Last February 1996, a *New York Times* article quoted the diplomat's comment about charges that Pinochet had ordered the assassination of a pro-democracy commander in Chile's army: "It's one thing to kill a civilian whom you think is a Communist, but it's another to kill your own men."

News articles from foreign capitals often recite the views of "Western diplomats". The phrase drips with authority and objectivity, but it should set off alarm bells. When officials don such masks, they're usually trying to obscure the specific agendas they're pushing. In fact, a "Western diplomat" cited in the American press is commonly a US government official posted overseas—an embassy staffer or perhaps the ambassador. We'll never know. The reporter knows but has promised not to tell.

Meanwhile, journalists based in Washington are also in the habit of relying on anonymous sources. It was nothing out of the ordinary two weeks ago when the *New York daily Newsday* quoted "a senior US official" who condemned Iraqi attacks on Kurdish areas as "a very bold and very aggressive move that cannot be overlooked or ignored".

The same American official supplied the last words in the article, proclaiming that Saddam Hussein "is as clever as he is ruthless". It would be difficult to quarrel with such an assertion. But why did it have to be made behind a nameless cloak?

One of the main problems with media reliance on official sources—named and unnamed—is what they *don't* say. "Western diplomats" and "senior US officials" aren't likely to offer information that contradicts the government line.

This month, hundreds of news stories have touted White House concern for the well-being of Kurds. Official sources are hardly inclined to remind reporters that President Clinton has been shrugging while the Turkish government repeatedly bombs Kurdish enclaves. With the help of massive US military aid, Turkey's fierce attacks on Kurds occur on both sides of the Turkey-Iraq border.

News media are supposed to provide us with a window on the world, but much too often it's tinted red, white and blue—as if faraway events matter mostly because of how they affect US government strategists. That preoccupation was clear on PBS television the other night when *NewsHour* anchor Jim Lehrer read his script:

"We focus next tonight on the Kurds," said Lehrer. "They are a people often forgotten by history but whose latest fighting is causing major problems for the United States in the Middle East."

No doubt, many Kurds would be interested to learn that their suffering has significance when it causes "major problems" for Washington.

That's how the world looks when journalists see it through the eyes of American officials.

(This is Norman Solomon's "Media Beat" syndicated column for w/c 16 September 1996, distributed by Creators Syndicate to about 20 daily US newspapers and via CompuServe. For more information, send e-mail to: mediabeat-info@igc.org)

The *ESP* of *ESP*ionage

By understanding how biophysical fields operate, we can learn to develop our innate telepathic and telekinetic abilities. But it all takes time and practice, and the military has a head start!

Part 2

by Turan Rifat © 1996

Paranormal Management Systems
PO Box 2749
Brighton, Sussex BN2 2DR, UK
Telephone: +44 (0)1273 690424
Web site address:
<http://www.fastnet.co.uk/pms>

THE BIOLOGICAL BASIS OF TELEPATHY

Throughout recorded history, mind-reading has been a recognised, albeit fleeting, phenomenon. We have all had moments where we've known what was in another person's mind, though the telepathic episodes have been transient and non-reproducible. As a scientist, I have been researching the biological basis of telepathy and extra-sensory perception (ESP) in an attempt to understand the phenomena.

The military has long been interested in ESP, for the ability to read the enemy's minds has tremendous strategic and tactical value. However, the military experiments that were undertaken within the USA to demonstrate ESP and telepathy had an ulterior intent which has never been revealed. In military jargon, telepathy is referred to as "scanning".

Pathetic snippets of information about ESP phenomena filter into the scientific community, but the leading parapsychological institutes in the UK and Europe are staffed by nothing more than glorified social scientists who mistakenly think psychology will open up ESP—if it exists at all—to scientific analysis.

While telepathy and ESP, like UFOs, do not exist as far as the Western scientific community is concerned, insiders in the US secret government have long known that these phenomena are real, while in Russia the military uses of telepathy and ESP have been well-researched.¹ Development and deployment of telepathic weapons systems have been going on since the 1960s. However, US Government agencies' failure to duplicate Russian advances in the biophysical field, prompted them to develop synthetic telepathy. This is the electronic scanning of a target's brain by monitoring its electromagnetic (EM) emissions and using, among other things, the P300 brainwaves (as measured on an EEG) to read that person's subvocalised thoughts.²

For the last five years the Japanese corporation Sony has ploughed millions of yen into researching ESP and telepathy.³ So, if these phenomena do not exist, why are the big players spending fortunes on research, and why is all the meaningful research classified? The answer is that 'the powers that be' wish to use this ESP research for military purposes and for civilian control. As an independent researcher in the field, I have no such aims.

LANGUAGE ACQUISITION

The following is a cutting-edge analysis of how telepathy and ESP might work. To begin my story of the scientific basis of telepathy and ESP, I choose to start the discussion with the more prosaic subject of language. Dr Noam Chomsky, a leading authority on language, has put forward the idea that "the language organ was not an adaptation but...a mystery, or a hopeful monster. It was something that perhaps would be illuminated some day by physics, but not by biology."⁴

Chomsky proposed that the structure of language is primarily fixed in the form of innately specified rules, and all the human baby does to learn language is to reroute a few neuronal pathways for speaking Spanish rather than English, for example. According to Chomsky, the baby is not a general problem-solver who must learn all the aspects of language from scratch. Instead, the baby is born with the equipment to express language and merely has to rule out a few possible neuronal pathways and rule in a few others. The great man goes further by stating that it is easy for even 'slow' children to learn a language. Actually, they are not really learning anything. A few developmental triggers set the language-acquisition process and a few environmental factors guide the process into the shaping of whatever country's language is spoken; for example, the form of speaking English with an Australian accent.⁵ It seems that babies are born with the ability to speak. Given the correct stimulus, this innate characteristic just develops.

So, is language hardwired into the brain or not? If it is not, what information storage system facilitates the rapid learning of language in infants? It is common knowledge that the neurones in the brain evolve by competitive pathways and that many of these neurones die.⁶ If language were hardwired into the brain, it would surely have to be hardwired into very deep, ancient parts. But the older parts of the brain, such as the limbic and reptilian brain centres, came into being long before language, so it is not a good idea to suggest that hardwired language neuronal networks are in place in these older parts of the brain.

MORPHOGENETIC FIELDS

To answer this language acquisition question, we must consider that organisms are conceived with insufficient information in their genomes to organise development of the fertilised egg into a foetus. Developmental biologists have had to give recourse to field effects that guide the morphological development of the blastocyst (the small clump of fertilised cells). 'Arch heretic' Rupert Sheldrake has postulated the existence of morphogenetic fields that carry the information and help direct development of the blastocyst into a foetus.⁷

Could a morphogenetic field also carry the information for language development? If so, this would be a biophysical field effect and would therefore be explainable "by physics, but not by biology", as Noam Chomsky has proposed. If biophysical fields contain the seminal information for language, then these field effects could also control the development of language in a baby. The acquisition of language would therefore be as natural as a seal learning to swim: an innate, preprogrammed, quasi-instinctual ability that only needed to be practised to be perfected. Once the biophysical field effect was activated, it would set neuronal pathways in Broca's body and other speech centres in the brain into conformations dedicated to language.

Since neuronal pathways grow by selective, competitive cell death, these pathways, once set, would remain. This may explain why it is so difficult to learn new languages in later life—after the biophysical field effects have been activated and completed their programme of hardwiring neuronal pathways into the speech centres.

The idea that there is a higher reality containing the intents of all things is ancient. The theory of Eternal Platonic Fixed Points—that seminal ideas exist for everything in creation—could surely be applied to language.⁸ If the seminal intents for language exist in biophysical fields, these fields would naturally hold the information for language acquisition extragenetically. So, do biophysical fields act as carriers of information? It has already been postulated that morphogenetic fields carry the information for cell development.

Many great thinkers throughout history have put forward the notion that ideas exist in a reality of their own.⁹ This reality has been proposed as 'the other side' in the theory of dualism—that there exists another reality where the mind has its residence.¹⁰ Since this reality is made up of 'mindstuff', it would naturally contain the ideas for everything, including language.¹¹

As a scientist, I would have to ask, "What is the physical nature of this second reality and how does it interact with physical reality?" I would suggest that this second reality is made up of bio-

physical, bioplasmic and biotronic field effects which can interact with the neurones in the brain by affecting the rate of calcium efflux at these sites. Since calcium efflux events in the neurones are intimately connected with short- and long-term potentiation of these sites, it is the way by which field effects can input and output memories in the brain and intimately control the state of excitation and potential excitation in the neurones.

By biophysical interaction and mediation of calcium efflux events in the neurones, natural biophysical field effects—which comprise the mind—can synergistically reside in the totality of the organism. Unlike the findings of earlier researchers in this area, my findings suggest that the brain and the biophysical fields can both be conscious, independently of one another. When they work together there is a synergistic amplification of function and a reduction in chaotic processes.

The discovery that humans may indeed possess biophysical fields with the potential to be conscious, may offer an explanation for OOBES (out-of-body experiences), dreaming, *doppelgängers* and a host of other paranormal phenomena. If conscious biophysical fields can leave our physical bodies, then knowledge at a distance may be possible.

Rupert Sheldrake has posited that if we are influenced by the morphogenetic fields of particular individuals to whom we are linked, then it is possible that we might pick up their thoughts, images and feelings while we are waking or dreaming, even though they may be thousands of miles away.¹²

In controlled ESP, the operator sends his [or her] biophysical field to interact with the person being scanned. In spontaneous telepathy, other people's biophysical fields might impinge on our own, causing their thoughts to enter our heads. This may be as commonplace as, for example, knowing someone is going to ring or visit you, just before for the event occurs. But since our biophysical

fields are generally latent, and almost never approach high-order consciousness, these spontaneous ESP or paranormal phenomena are fairly rare.

So, why should reality need to have a dualistic nature? Recently, physicists have discovered that duality, when incorporated into new unified-field theories, seems to offer ways of cancelling out the infinities that appear when renormalising many of the field equations dealt with in grand unified field theories. In my research into the physics of the paranormal I have found that dualistic field effects are required to establish meaningful results.

If a biophysical field resides around humans, and this field comprises the mind, then this means we all have access to a realm where ideas have a reality. Mindstuff, of a nature only mystics have alluded to, may in fact merely be biophysical field phenomena. These biophysical fields contain massive amounts of information from the past; thus, by learning to tap into these fields, ESP-trained operators are able to see into the past.

Remote viewers Joe McMoneagle¹³ and Ingo Swann have used RV techniques to look at the past as well as the future—which would suggest that biophysical fields are not limited by time. If this is correct, then biophysical field effects from the past could affect the future, and we would have a pathway by which information from past lives could affect people alive today.¹⁴

Biophysical fields do not die with the death of the physical body. The ancient Egyptians used the term *ka* to describe one

In controlled ESP, the operator sends his [or her] biophysical field to interact with the person being scanned.
In spontaneous telepathy, other people's biophysical fields might impinge on our own, causing their thoughts to enter our heads.

aspect of these human biophysical field effects. After death, the *ka* was supposed to exist for another six months before it passed on. My research into after-life biophysical field effects seems to indicate that the higher the energy field of the person who has died, the longer their biophysical field can survive after death. A young person killed in the prime of life may have biophysical remnants remaining for a long period of time after death. Such an effect may be responsible for the phenomenon of ghosts.

It's possible that we may also have alien biophysical field effects from other dimensions impinging on our biophysical fields or casting the rightful human biophysical field out of the physical body. This mechanism may underlie the phenomenon of possession. Akin to this, there may also be a form of alien abduction from our own continuum, where the biophysical fields are removed and alien field effects implanted. It would appear that US military research in this area is being conducted at Dulce, New Mexico.¹⁵ This may tie in with a report from the US military remote-viewer who was retired after he became convinced there was a Martian colony below the New Mexico desert.¹⁶

BIOPHYSICAL FIELD EFFECTS AND TELEPATHY

Returning to our discussion of telepathy and its links with the way language develops in children, if the intents for language reside in biophysical fields that we inherit from our parents, and these fields mirror what we are thinking in our minds or are part of the process of mentation, then the biophysical interaction between different people's minds (as discussed previously) gives a method by which telepathy can function.

To become a controlled telepath one must 'evolve' the biophysical fields that comprise the mind, from primary consciousness to high-order consciousness—rather like the neuronal selection process in our own brains.¹⁷ In this process of neuronal Darwinian selection, the neurones compete with each other and the failures die, producing a hardwired neuronal network in our brains. This network can evolve by competitive cell death throughout one's life, resulting in a labile, hardwired brain that can grow new neural pathways in response to stimuli.

So, if our biophysical fields are capable of a process analogous to biophysical Darwinian selection, this means it would be possible to control these fields consciously, to make them evolve from morphogenetic fields to primary consciousness and hence to high-order consciousness. In this final state, remote viewing, ESP and telepathy become possible. To achieve this, it means that we have to train our biophysical fields to become fully aware. An example of this would be the lucid dreaming state.¹⁸

Raising the consciousness of our biophysical fields is very difficult because we are programmed from birth to believe that these fields do not exist. When children mention their awareness of this biophysical world, they are told to stop daydreaming and behave like adults. By this method of adult social control, biophysical awareness is suppressed and our minds never grow. What we think of as the mind is in fact the brain, which is fully conscious, independent of biophysical field phenomena.

Remote viewers have to develop their biophysical fields to primary consciousness level in order to become aware of information from distant locations. By using RV they can also develop the biophysical field to the point where it can become detached from the body and roam at will. But all this takes time and prac-

tice.¹⁹ It would be a simple process if we did not live in modern society, but lived instead in a culture that believed in another area of awareness—as do the Australian Aborigines, who regard the Dreamtime as more real than the physical world.

Telepathic scanning of another person involves use of remote-viewing techniques. In military telepathy, the operator scans a target by projecting his biophysical RV awareness at the person of interest. Remote viewing (RV), as applied to people, is called remote sensing (RS).²⁰ In RS, the operator learns how to mesh his biophysical fields with those of the target. In this way, the telepath's RV vehicle can interact with the primitive biophysical body of the target.

As discussed previously, the biophysical fields are information-rich. By attuning the biophysical RV body to that of the target, the easiest thing to pick up is emotion. Indeed, empathic telepathic awareness is one of the easiest things to learn in the telepath's training regimen. Emotional states resound through the fabric of people's biophysical fields, and throughout the day we pick up emotional emanations from the people around us. Development of this normal instinctual awareness is the first step in telepathic training.

US military interest in this area was stimulated by information it received in 1973 about a top-secret psychical research base to the northeast of Leningrad.

Development of the RV biophysical body allows the operator's field to begin to scan the language information contained in the target's biophysical body. Since the seminal intents of language are held in the biophysical body, the telepath can project his own biophysical body at the target and scan the language intents contained in that person's biophysical field. Thoughts which pass through the person's head light up those specific language intents in the biophysical corona around the target. The telepath can tune into this language information by merging his biophysical body with that of the target and uploading the information running through the target's biophysical fields.

Once the information has been uploaded, the telepath's biophysical body can return to the physical body. The telepath can then use the information downloaded from the target to begin reading information held in the target's seminal language intents. These seminal language intents are common to each language group, so an English-speaking telepath can use an English-speaking target to supply the seminal language intents for his mind's and brain's thought-trains. The end result of this is that the telepath begins to comprehend what is on the target's mind. Gradual development of this process allows the telepath to become more accurate in the reading of the target's mind.

Since RV biophysical vehicles travel instantaneously between target and telepath, this process can go on as a steady datastream. The telepath's RV biophysical vehicle goes to the target's biophysical field, uploads seminal language intents flitting through the biophysical corona of the target, then returns to the telepath's body. Downloading information into the telepath's brain, the biophysical body then returns to the target to continue the process. This backwards-and-forwards process can go on at such speed that seamless telepathic input can occur in the trained ESP operator.

Telepathy becomes a little more difficult with foreign language speakers, but since all mankind shares the same archetypal seminal language intents, the telepath can learn to comprehend the mind of a foreigner. Accuracy is reduced, but, with practice, meaningful datastreams can be comprehended.

RESEARCH INTO TELEKINESIS

It was the Russian military that developed these telepathic techniques and has been honing them ever since. The feeble discussions that Western psychologists have about the veracity of even the simplest telepathic signals—and their hedging on whether telepathy really exists—are seen by the Russians as humorous.

"Russians are the only people we know of who tried bugging telepathy," stated American/Canadian psychical investigators Sheila Ostrander and Lynn Schroeder.²¹ By introducing a third telepath, who knew when language-embedded biophysical information-streams flowed between two other telepaths, the Russians found the biophysical datastream could not only be broken into but could be changed by the third telepath who could substitute new language-embedded biophysical fields. By this method, the Russians learnt how to hack into telepathic conversations and then to proceed to substitute fallacious messages and ideas into the minds of the other two telepaths.²² In developing this line of research, psi-able operators learnt how to fuse their biophysical fields to form a group mind.

US military interest in this area was stimulated by information it received in 1973 about a top-secret psychical research base to the northeast of Leningrad.²³ The Russians' advances in ESP and telekinesis seemed to be leading them toward the ability to cause physical effects. This frightened the US missile command, as the ability of Russian psychics to disable US ballistic missiles in their silos or in flight could destroy the American deterrent capability.

In 1975, a nuclear engineer by the name of Thomas Bearden was commissioned by the US Army to research this area of Russian psychical research, called psychotronics. This area of group-augmented telepathic telekinesis follows on from the merging of telepaths' minds, for a large number of Russian telepaths could create thought-forms out of the collective unconscious and cause materialisation.

Psychotronics research has been of especial interest to me. Since biophysical fields mediate the transfer of language-embedded information between telepaths, they could potentially transfer other types of information. As we have seen, information embedded in biophysical fields may be able to carry information from distant locations and different times to the remote viewer. Biophysical fields, since they originate in a dualistic reality in a realm contiguous with the physical world, may prove to be the mechanism by which spiritualistic phenomena such as ghosts and demonic possession may occur. If we take into account other levels of reality, alien visitors from other dimensions can also be understood as the transference of alien biophysical energy into our realm from other continuums.²⁴

By developing this theory of biophysical field phenomena in a contiguous reality, it may be possible to explain psychotronic phenomena. When two telepaths get together, a melding of fields takes place because their biophysical fields have reached high-order consciousness. This is akin to the merging of energy orbitals when atoms combine to form molecules. This group mind has much more potential than that of a single person, so

access to reality-altering states becomes possible.

In my research into telekinesis, I have found that the psychokinetic effect is analogous to the electromotive force described in Maxwell's equation.

In this equation, force (F) = charge (q) x [electric field (E) + velocity (v_e) X magnetic field (B)].

If we modify this equation for biophysical fields, we get: telekinetic force (T) = position vector of field in Riemann manifold (P) x [E analogue of biophysical field (A) + velocity (v_p) X B analogue of biophysical field (Z)].

The Z component is the interesting biophysical field effect in telekinesis, in that movement of this field will amplify telekinetic effects. I have put forward a theory of telepathy where biophysical fields move from telepath to subject with an almost instantaneous velocity of interaction, but it follows that development of high-order consciousness can lead to marked telekinetic ability. In telekinesis, the operator's biophysical field is thrust at the target with extreme power—unlike telepathy where the field oscillates between telepath and subject, thus cancelling out any psychokinetic effects.

Both superpowers became interested in telekinesis because of its military implications. Telekinetic effects may be small, but not much force is needed to ruin a circuit board in a missile guidance system or tear open a brain capillary. Rumours that the Russians can remotely kill targets up to 1,000 kilometres away (as stated by Vladimir Zhirinovskiy on British television) may indeed be true.

The force that is at the heart of telekinesis would explain psychotronic phenomena. The merging of telepaths into a group mind would amplify the telekinetic effect. If the effect were not simply additive but of a higher order, then large-scale telekinetic effects might be possible. My research has linked the telekinetic effect with the force that collapses the quantum state function to produce events. In this way, telekinesis could be used to collapse the universal quantum wave function and change the way events manifest. Telekinesis could also be used to collapse the biophysical field effects on the other side of dualistic

reality, to create thought-forms that could manifest specific effects.

If one thinks of natural biophysical fields merging to form a global biophysical biosphere, then in this sea of the collective unconscious, lesser groupings of human biophysical field effects might coalesce to form racial archetypes, as postulated by Carl Jung.²⁵ Groups of telepaths could theoretically use telekinesis to manifest thought-forms from the pool of archetypes in the collective unconscious, and then go further and manifest thought-forms from the collective unconscious.

With populations as a whole being unaware of any paranormal dimension to reality, directed thought-forms that could affect the mental states of nations would be a useful weapon system or a tool of *realpolitik*. Consequently, psychotronics has become one of the chief research interests in military paranormal research facilities both in Russia and the USA.

It would appear that US military research in this area is being conducted at Dulce, New Mexico.

This may tie in with a report from the US military remote-viewer who was retired after he became convinced there was a Martian colony below the New Mexico desert.

Continued on page 81

Polluted Pet Food

Commercial pet food and stock feed contain a cocktail of dead domestic animals and deadly environmental toxins.

Warning: these four short articles will make you rethink what you feed to your pets, and even what you and your family eat.

Reprinted with permission from
Earth Island Journal

(vol. 11, no. 3, Summer 1996)

(vol. 5, no. 4, Fall 1990)

300 Broadway, Suite 28

San Francisco, CA 94133, USA

Phone: +1 (415) 788 3666

Fax: +1 (415) 788 7324

E-mail: earthisland@igc.apc.org

Web page: <http://www.earthisland.org/ei/>

1. THE TRUTH ABOUT CATS AND DOGS

by Ann Martin

The pet food industry, a billion-dollar, unregulated operation, feeds on the garbage that otherwise would wind up in landfills or be transformed into fertiliser. The hidden ingredients in a can of commercial pet food may include roadkill and the rendered remains of cats and dogs. The pet food industry claims that its products constitute a "complete and balanced diet" but, in reality, commercial pet food is unfit for human or animal consumption.

"Vegetable protein", the mainstay of dry dog foods, includes ground yellow corn, wheat shorts and middlings, soybean meal, rice husks, peanut meal and peanut shells (identified as "cellulose" on pet food labels). These often are little more than the sweepings from milling room floors. Stripped of their oil, germ and bran, these "proteins" are deficient in essential fatty acids, fat-soluble vitamins and antioxidants. "Animal protein" in commercial pet foods can include diseased meat, roadkill, contaminated material from slaughterhouses, faecal matter, rendered cats and dogs and poultry feathers. The major source of animal protein comes from dead-stock removal operations that supply so-called "4-D" animals—dead, diseased, dying or disabled—to "receiving plants" for hide, fat and meat removal. The meat (after being doused with charcoal and marked "unfit for human consumption") may then be sold for pet food.

Rendering plants process decomposing animal carcasses, large roadkill and euthanised dogs and cats into a dry protein product that is sold to the pet food industry. One small plant in Quebec, Ontario, renders 10 tons (22,000 pounds) of dogs and cats per week. The Quebec Ministry of Agriculture states that "the fur is not removed from dogs and cats" and that "dead animals are cooked together with viscera, bones and fat at 115° C (235° F) for 20 minutes".

The US Food and Drug Administration's Center for Veterinary Medicine (CVM) is aware of the use of rendered dogs and cats in pet foods, but has stated: "CVM has not acted to specifically prohibit the rendering of pets. However, that is not to say that the practise of using this material in pet food is condoned by the CVM."

In both the US and Canada, the pet food industry is virtually self-regulated. In the US, the Association of American Feed Control Officials (AAFCO) sets guidelines and definitions for animal feed, including pet foods. In Canada, the most prominent control is the "Labeling Act", simply requiring product labels to state the name and address of the manufacturer, the weight of the product and whether it is dog or cat food. The Canadian Veterinary Medical Association (CVMA) and the Pet Food Association of Canada (PFAC) are voluntary organisations that, for the most part, rely on the integrity of the companies they certify to assure that product ingredients do not fall below minimum standards.

The majority—85 to 90 per cent—of the pet food sold in Canada is manufactured by US-based multinationals. Under the terms of the US-Canada Free Trade Agreement, neither the CVMA nor PFAC exercises any control over the ingredients in cans of US pet food.

Pet food industry advertising promotes the idea that, to keep pets healthy, one must feed them commercially formulated pet foods. But such a diet contributes to cancer, skin problems, allergies, hypertension, kidney and liver failure, heart disease and dental problems. One more item should be added to pet food labels: a skull-and-crossbones insignia!

(Ann Martin is an animal rights activist and leading critic of the commercial pet food industry. She lives in London, Ontario, Canada.)

2. FOOD NOT FIT FOR A PET

by Dr Wendell O. Belfield, D.V.M.

The most frequently asked question in my practice is, "Which commercial pet food do you recommend?" My standard answer is "None." I am certain that pet-owners notice changes in their animals after using different batches of the same brand of pet food. Their pets may have diarrhoea, increased flatulence, a dull hair coat, intermittent vomiting or prolonged scratching. These are common symptoms associated with commercial pet foods.

In 1981, as Martin Zucker and I wrote *How to Have a Healthier Dog*, we discovered the full extent of negative effects that commercial pet food has on animals. In February 1990, *San Francisco Chronicle* staff writer John Eckhouse went even further with an exposé entitled "How Dogs and Cats Get Recycled into Pet Food".

Eckhouse wrote: "Each year, millions of dead American dogs and cats are processed along with billions of pounds of other animal materials by companies known as renderers. The finished product...tallow and meat meal...serve as raw materials for thousands of items that include cosmetics and pet food."

Pet food company executives made the usual denials. But federal and state agencies, including the Food and Drug Administration, and medical groups, such as the American Veterinary Medical Association and the California Veterinary Medical Association (CVMA), confirm that pets, on a routine basis, are rendered after they die in animal shelters or are disposed of by health authorities—and the end product frequently finds its way into pet food.

Government health officials, scientists and pet food executives

argue that such open criticism of commercial pet food is unfounded. James Morris, a professor at the School of Veterinary Medicine at Davis, California, has said, "Any products not fit for human consumption are very well sterilised, so nothing can be transmitted to the animal." Individuals who make such statements know nothing of the meat and rendering business.

For seven years I was a veterinary meat inspector for the US Department of Agriculture and the State of California. I waded through blood, water, pus and faecal material, inhaled the fetid stench from the killing floor and listened to the death cries of slaughtered animals.

Prior to World War II, most slaughterhouses were all-inclusive; that is, livestock was slaughtered and processed in one location. There was a section for smoking meats, a section for processing meats into sausages, and a section for rendering. After World War II, the meat industry became more specialised. A slaughterhouse dressed the carcasses, while a separate facility made the sausages. The rendering of slaughter waste also became a separate speciality—no longer within the jurisdiction of federal meat inspectors and out of the public eye.

To prevent condemned meat from being rerouted and used for human consumption, government regulations require that meat be "denatured" before removal from the slaughterhouse and shipment to rendering facilities. In my time as a veterinary meat inspector, we denatured with carbolic acid (a potentially corrosive disinfectant) and/or creosote (used for wood-preservation or as a disinfectant). Both substances are highly toxic. According to federal meat inspection regulations, fuel oil, kerosene, crude carbolic acid and citronella (an insect repellent made from lemon grass) are all approved denaturing materials.

3. A LOOK INSIDE A RENDERING PLANT

by Gar Smith

Rendering has been called "the silent industry". Each year in the US, 286 rendering plants quietly dispose of more than 12.5 million tons of dead animals, fat and meat wastes. As the public relations watchdog newsletter *PR Watch* observes, renderers "are thankful that most people remain blissfully unaware of their existence".

When *City Paper* reporter Van Smith visited Baltimore's Valley Proteins rendering plant last summer, he found that the "hoggers" (the large vats used to grind and filter animal tissues prior to deep-fat-frying) held an eclectic mix of body parts ranging from "dead dogs, cats, raccoons, possums, deer, foxes [and] snakes" to a "baby circus elephant" and the remains of Bozeman, a Police Department quarter-horse that "died in the line of duty".

In an average month, Baltimore's pound hands over 1,824 dead animals to Valley Proteins. Last year, the plant transformed 150 millions pounds of decaying flesh and kitchen grease into 80 million pounds of commercial meat and bone meal, tallow and yellow grease. Thirty years ago, most

of the renderer's wastes came from small markets and slaughterhouses. Today, thanks to the proliferation of fast-food restaurants, nearly half the raw material is kitchen grease and frying oil.

Recycling dead pets and wildlife into animal food is "a very small part of the business that we don't like to advertise," Valley Proteins' President, J. J. Smith, told *City Paper*. The plant processes these animals as a "public service, not for profit," Smith said, since "there is not a lot of protein and fat [on pets]...., just a lot of hair you have to deal with somehow."

According to *City Paper*, Valley Proteins "sells inedible animal parts and rendered material to Alpo, Heinz and Ralston-Purina". Valley Proteins insists that it does not sell "dead pet by-products" to pet food firms since "they are all very sensitive to the recycled pet potential". Valley Proteins maintains two production lines—one for clean meat and bones and a second line for dead pets and wildlife. However, Van Smith reported, "the protein material is a mix from both production lines. Thus the meat and bone meal made at the plant includes materials from pets and wildlife, and about five per cent of product goes to dry-pet-food manufacturers..."

A 1991 USDA report states that "approximately 7.9 billion pounds of meat and bone meal, blood meal and feather meal [were] produced in 1983". Of that amount, 34 per cent was used in pet food, 34 per cent in poultry feed, 20 per cent in pig food and 10 per cent in beef and dairy cattle feed.

Transmissible spongiform encephalopathy (TSE) carried in pig- and chicken-laden foods may eventually eclipse the threat of "mad cow disease". The risk of household pet exposure to TSE from contaminated pet food is more than three times greater than the risk for hamburger-eating humans.

(Gar Smith is Editor of *Earth Island Journal*.)



Barrels filled with euthanised dogs and cats await transfer to a Baltimore rendering plant. (Photo credit: Michelle Gienow, *City Paper*)

Condemned livestock carcasses treated with these chemicals can become meat and bone meal for the pet food industry. Because rendering facilities are not government-controlled, any animal carcasses can be rendered—even dogs and cats. As Eileen Layne of the CVMA told the *Chronicle*, "When you read pet food labels, and it says "meat and bone meal", that's what it is: cooked and converted animals, including some dogs and cats."

Some of these dead pets—those euthanised by veterinarians—already contain pentobarbital before treatment with the denaturing process. According to University of Minnesota researchers, the sodium pentobarbital used to euthanise pets "survives rendering without undergoing degradation". Fat stabilisers are introduced into the finished rendered product to prevent rancidity. Common chemical stabilisers include BHA (butylated hydroxyanisole) and BHT (butylated hydroxytoluene)—both known to cause liver and kidney dysfunction—and ethoxyquin, a suspected carcinogen. Many semi-moist dog foods contain propylene glycol—first cousin to the anti-freeze agent, ethylene glycol, that destroys red blood-cells. Lead frequently shows up in pet foods, even those made from livestock meat and bone meal. A Massachusetts Institute of Technology study, titled "Lead in Animal Foods", found that a nine-pound cat fed on commercial pet food ingests more lead than the amount considered potentially toxic for children.

I have been practising small-animal medicine for more than 25 years. Every day I see the casualties of pet industry propaganda. But the professors in the teaching institutions of veterinary medicine generally support an industry that has little regard for the quality of health in our companion animals.

One last word of caution: meat and bone meal from sources not fit for human consumption have found their way into poultry feed. This means that animal products rendered under questionable conditions are fed to birds that may wind up on your table. Remember this when you are eating your next piece of chicken or turkey.

(Dr Belfield is a graduate of Tuskegee Institute of Veterinary Medicine and is now in private practice in San Jose, California. Dr Belfield established the first orthomolecular veterinary hospital in the US. He is co-author of *The Very Healthy Cat Book* and *How to Have a Healthier Dog*. This article first appeared in *Let's Live Magazine*, May 1992.)



Photo credit: Eban Fleaux

4. THE DARK SIDE OF RECYCLING

[Author's name withheld]

[In February 1990, the San Francisco Chronicle carried a macabre two-part story detailing how stray dogs, cats and pound animals are routinely rounded up by meat renderers and ground up into—of all things—pet food. According to the researcher who brought the information to the Chronicle, the paper buried the story and deleted many of the charges he had documented. A report he worked on for ABC television's 20-20 was similarly watered down. In exasperation, he sent the story to Earth Island Journal. NEXUS has been asked to withhold the name of the author/researcher, who has been forced to flee San Francisco with his wife and go into hiding as a result of the threats made against his well-being. Ed.]

The rendering plant floor is piled high with "raw product": thousands of dead dogs and cats; heads and hooves from cattle, sheep, pigs and horses; whole skunks; rats and raccoons—all waiting to be processed. In the 90-degree heat, the piles of dead animals seem to have a life of their own as millions of maggots swarm over the carcasses.

Two bandana-masked men begin operating Bobcat mini-dozers, loading the "raw" into a 10-foot-deep stainless-steel pit. They are undocumented workers from Mexico, doing a dirty job. A giant auger-grinder at the bottom of the pit begins to turn. Popping bones and squeezing flesh are sounds from a nightmare you will never forget.

Rendering is the process of cooking raw animal material to remove the moisture and fat. The rendering plant works like a giant kitchen. The cooker, or "chef", blends the raw product in order to maintain a certain ratio between the carcasses of pets,

livestock, poultry waste and supermarket rejects.

Once the mass is cut into small pieces, it is transported to another auger for fine shredding. It is then cooked at 280 degrees for one hour. The continuous batch cooking process goes on non-stop, 24 hours a day, seven days a week as meat is melted away from bones in the hot 'soup'. During this cooking process, the 'soup' produces a fat of yellow grease or tallow that rises to the top and is skimmed off. The cooked meat and bone are sent to a hammermill press, which squeezes out the remaining moisture and pulverises the product into a gritty powder. Shaker screens sift out excess hair and large bone chips. Once the batch is finished, all that is left is yellow grease, meat and bone meal.

A Meaty Menu

As the *American Journal of Veterinary Research* explains, this recycled meat and bone meal is used as "a source of protein and other nutrients in the diets of poultry and swine and in pet foods, with lesser amounts used in the feed of cattle and sheep. Animal fat is also used in animal feeds as an energy source." Every day, hundreds of rendering plants across the United States truck millions of tons of this "food enhancer" to poultry ranches, cattle feed-lots, dairy and hog farms, fish-feed plants and pet-food manufacturers where it is mixed with other ingredients to feed the billions of animals that meat-eating humans, in turn, will eat.

NOTICE — All Animals Are To Be Destroyed In A Humane Manner and No Processing Is To Begin Until The Animal Has Expired.

— The Management

[Sign on the wall of a rendering plant]

Rendering plants have different specialities. The labelling designation of a particular "run" of product is defined by the predominance of a specific animal. Some product-label names are: meat meal, meat by-products, poultry meal, poultry by-products, fish meal, fish oil, yellow grease, tallow, beef fat and chicken fat.

Rendering plants perform one of the most valuable functions on Earth: they recycle used animals. Without rendering, our cities would run the risk of becoming filled with diseased and rotting carcasses. Fatal viruses and bacteria would spread uncontrolled through the population.

The Dark Side

Death is the number one commodity in a business where the demand for feed ingredients far exceeds the supply of raw product. But this elaborate system of food production through waste management has evolved into a recycling nightmare. Rendering plants are unavoidably processing toxic waste.

The dead animals (the "raw") are accompanied by a whole menu of unwanted ingredients. Pesticides enter the rendering process via poisoned livestock, and fish oil laced with bootleg DDT and other organophosphates that have accumulated in the bodies of West Coast mackerel and tuna.

Because animals are frequently shoved into the pit with flea collars still attached, organophosphate-containing insecticides get into the mix as well. The insecticide Dursban arrives in the form of cattle insecticide patches. Pharmaceuticals leak from antibiotics in livestock, and euthanasia drugs given to pets are also included. Heavy metals accumulate from a variety of sources: pet ID tags, surgical pins and needles.

Even plastic winds up going into the pit. Unsold supermarket meats, chicken and fish arrive in styrofoam trays and shrink wrap. No one has time for the tedious chore of unwrapping thousands of rejected meat-packs. More plastic is added to the pits with the arrival of cattle ID tags, plastic insecticide patches and the green plastic bags containing pets from veterinarians.

Rendering Judgements

Skyrocketing labour costs are one of the economic factors forcing the corporate flesh-peddlers to cheat. It is far too costly for plant personnel to cut off flea collars or unwrap spoiled T-bone steaks. Every week, millions of packages of plastic-wrapped meat go through the rendering process and become one of the unwanted ingredients in animal feed.

The most environmentally conscious state in the nation is California, where spot checks and testing of animal-feed ingredients happen at the wobbly rate of once every two-and-a-half months. The supervising state agency is the Department of Agriculture's Feed and Fertilizer Division of Compliance. Its main objective is to test for truth in labelling: does the percentage of protein, phosphorous and calcium match the rendering plant's claims; do the percentages meet state requirements? However, testing for pesticides and other toxins in animal feeds is incomplete.

In California, eight field inspectors regulate a rendering industry that feeds the animals that the state's 30 million people eat. When it comes to rendering plants, however, state and federal agencies have maintained a hands-off policy, allowing the industry to become largely self-regulating. An article in the February

1990 issue of *Render*, the industry's national magazine, suggests that the self-regulation of certain contamination problems is not working.

One policing program that is already off to a shaky start is the Salmonella Education/Reduction Program, formed under the auspices of the National Renderers Association. The magazine states that "...unless US and Canadian renderers get their heads out of the ground and demonstrate that they are serious about reducing the incidence of salmonella contamination in their animal protein meals, they are going to be faced with...new and overly stringent government regulations."

So far, the voluntary self-testing program is not working. According to the magazine, "...only about 20 per cent of the total number of companies producing or blending animal protein meal have signed up for the program..." Far fewer have done the actual testing.

Because animals are frequently shoved into the pit with flea collars still attached, organophosphate-containing insecticides get into the mix as well.

The *American Journal of Veterinary Research* conducted an investigation into the persistence of sodium phenobarbital in the carcasses of euthanised animals at a typical rendering plant in 1985 and found "...virtually no degradation of the drug occurred during this conventional rendering process..." and that "...the potential of other chemical contaminants (e.g., heavy metals, pesticides and environmental toxicants, which may cause massive herd mortalities) to degrade during conventional rendering needs further evaluation."

Renderers are the silent partners in our food chain. But worried insiders are beginning to talk, and one word that continues to come up in conversation is "pesticides". The possibility of petrochemically poisoning our food has become a reality. Government agencies and the industry itself are allowing toxins to be inadvertently recycled from the streets and supermarket shelves into the food chain. As we break into a new decade of increasingly complex pollution problems, we must rethink our place in the environment. No longer hunters, we are becoming the victims of our technologically altered food chain.

The possibility of petrochemically poisoning our food has become a reality.

(First published in *Earth Island Journal*, Fall 1990.)

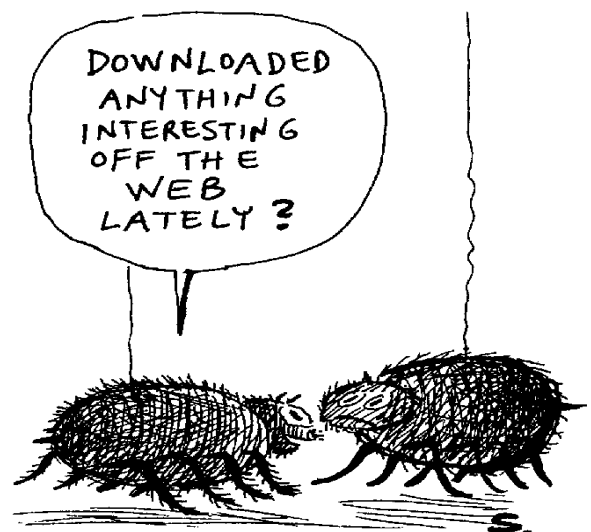

The Explosive Secrets of *Major Jordan's Diaries*

Major George Jordan started a diary in 1942 when he became suspicious of US-sanctioned air shipments to the USSR. But he never expected to uncover a secret American WWII deal to give the Russians the raw materials and know-how to make atomic bombs!

Part 1

Extracted from
From Major Jordan's Diaries
© 1952 by George Racey Jordan,
USAF (Ret.)
with Richard L. Stokes
Originally published in 1952 by
Harcourt, Brace & Company, New York
Reprinted by American Opinion, 1961

"MR BROWN" AND THE START OF A DIARY

Late one day in May 1942, several Russians burst into my office at Newark Airport, furious over an outrage that had just been committed against Soviet honor. They pushed me toward the window where I could see evidence of the crime with my own eyes.

They were led by Colonel Anatoli N. Kotikov, the head of the Soviet mission at the airfield. He had become a Soviet hero in 1935 when he made the first seaplane flight from Moscow to Seattle along the Polar cap; Soviet newspapers of that time called him "the Russian Lindbergh". He had also been an instructor of the first Soviet parachute troops, and he had 38 jumps to his credit.

I had met Colonel Kotikov only a few days before, when I reported for duty on May 10, 1942. My orders gave the full title of the Newark base as "UNITED NATIONS DEPOT No. 8, LEND-LEASE DIVISION, NEWARK AIRPORT, NEWARK, NEW JERSEY, INTERNATIONAL SECTION, AIR SERVICE COMMAND, AIR CORPS, U.S. ARMY".

I was destined to know Colonel Kotikov very well, and not only at Newark. At that time he knew little English, but he had the hardihood to rise at 5.30 every morning for a two-hour lesson. Now he was pointing out the window, shaking his finger vehemently.

There on the apron before the administration building was a medium bomber, an A-20 Douglas Havoc. It had been made in an American factory, it had been donated by American Lend-Lease, it was to be paid for by American taxes, and it stood on American soil. Now it was ready to bear the Red Star of the Soviet Air Force.

As far as the Russians and Lend-Lease were concerned, it was a Russian plane. It had to leave the field shortly to be hoisted aboard one of the ships in a convoy that was forming to leave for Murmansk and Kandalaksha. On that day the Commanding Officer was absent and, as the acting Executive Officer, I was in charge.

I asked the interpreter what "outrage" had occurred. It seemed that a DC-3, a passenger plane, owned by American Airlines, had taxied from the runway and, in wheeling about on the concrete plaza to unload passengers, had brushed the Havoc's engine housing. I could easily see that the damage was not too serious and could be repaired. But that seemed to be beside the point. What infuriated the Russians was that it be tolerated for one minute that an American commercial liner should damage, even slightly, a Soviet warplane!

The younger Russians huddled around Colonel Kotikov over their Russian-English dictionary, and showed me a word: "punish". In excited voices they demanded: "Pooneeesh peelote!" I asked what they wanted done to the offending pilot. One of them aimed an imaginary revolver at his temple and pulled the trigger.

"You're in America," I told him. "We don't do things that way. The plane will be repaired and ready for the convoy."

They came up with another word: "Baneesh!" They repeated this excitedly over and over again. Finally I understood that they wanted not only the pilot, but American Airlines, Inc., expelled from the Newark field.

I asked the interpreter to explain that the US Army has no jurisdiction over commercial companies. After all, the airlines had been using Newark Airport long before the war and even before La Guardia Airport existed. I tried to calm down the Russians by explaining that our aircraft maintenance officer, Captain Roy B. Gardner, would have the bomber ready for its convoy even if it meant a special crew working all night to finish the job.

I remembered what General Koenig had said about the Russians when I went to Washington shortly after Pearl Harbor. He knew that in 1917 I had served in the Flying Machine Section, US Signal Corps, and that I had been in combat overseas. When he told me there was an assignment open for a Lend-Lease liaison officer with the Red Army Air Force, I was eager to hear more about it.

"It's a job, Jordan, that calls for an infinite amount of tact to get along with the Russians," the General said. "They're tough people to work with, but I think you can do it."

Thus I had been assigned to Newark for the express purpose of expediting the Lend-Lease program. I was determined to perform my duty to the best of my ability. I was a "re-tread", as they called us veterans of World War I, and a mere Captain at the age of 44—but I had a job to do and I knew I could do it. The first days had gone reasonably well and I rather liked Kotikov. But there was no denying it: the Russians were tough people to work with.

As my remarks about repairing the bomber on time were being translated, I noticed that Colonel Kotikov was fidgeting scornfully. When I finished, he made an abrupt gesture with his hand. "I call Mr Hopkins," he announced.

It was the first time I had heard him use this name. It seemed such an idle threat, and a silly one. What did Harry Hopkins have to do with Newark Airport? Assuming that Kotikov carried out his threat, what good would it do? Commercial planes, after all, were under the jurisdiction of the Civil Aeronautics Board.

"Mr Hopkins fix," Colonel Kotikov asserted. He looked at me and I could see now that he was amused in a grim kind of way. "Mr Brown will see Mr Hopkins, no?" he said, smiling.

The mention of "Mr Brown" puzzled me, but before I had time to explore this any further, Kotikov was barking at the interpreter that he wanted to call the Soviet Embassy in Washington. All Russian long-distance calls had to be cleared through my office, and I always made sure that the Colonel's, which could be extraordinarily long at times, were put through "collect". I told the operator to get the Soviet Embassy, and I handed the receiver to the Colonel.

By this time the other Russians had been waved out of the office, and I was sitting at my desk. Colonel Kotikov began a long harangue over the phone in Russian, interrupted by several trips to the window. The only words I understood were "American Airlines", "Hopkins", and the serial number on the tail which he read out painfully in English. When the call was completed, the Colonel left without a word. I shrugged my shoulders and went to see about the damaged Havoc. As promised, it was repaired and ready for hoisting on shipboard when the convoy sailed.

That, I felt sure, was the end of the affair.

I was wrong. On June 12th the order came from Washington, not only ordering American Airlines off the field but directing every aviation company to cease activities at Newark forthwith. The order was not for a day or a week. It held for the duration of the war, though they called it a "Temporary Suspension".

I was flabbergasted. It was the sort of thing one cannot quite believe, and certainly cannot forget. Would we have to jump whenever Colonel Kotikov cracked the whip? For me, it was going to be a hard lesson to learn.

Captain Gardner, who had been at Newark longer than I, and who was better versed in what he called the "push-button system", told me afterwards that he did not waste a second after I informed him that Colonel Kotikov had threatened to "call Mr Hopkins". He dashed for the best corner in the terminal building, which was occupied by commercial airlines people, and staked out his claim by fixing his card on the door. A few days later the space was his.

I was dazed by the speed with which the expulsion proceedings had taken place. First, the CAB inspector had arrived. Someone in Washington, he said, had set off a grenade under the Civil Aeronautics Board. He spent several days in the control tower, and put our staff through a severe quiz about the amount of commercial traffic and whether it was interfering with Soviet operations. The word spread around the field that there was going to be hell to pay. Several days later, the order of expulsion arrived. A copy of the order is reproduced in the centre section of this edition, a masterpiece of bureaucratic language.

I had to pinch myself to make sure that we Americans, and not the Russians, were the donors of Lend-Lease. "After all, Jordan," I told myself, "you don't know the details of the *whole* operation; this is only one part of it. You're a soldier, and besides, you were warned that this would be a tough assignment." At the same time, however, I decided to start a diary, and to collect records of one kind and another and make notes and memos of everything that occurred. This was a more important decision than I then realized.

Keeping a record wasn't exactly a revolutionary idea in the Army. I can still see Sergeant Cook, at Kelly Field, Texas, in 1917, with his sandy thatch and ruddy face, as he addressed me, a 19-year-old corporal, from the infinite superiority of a master sergeant in the regular Army: "Jordan, if you want to get along, keep your eyes and your ears open, keep your big mouth shut, and keep a copy of everything!"

Now I felt a foreboding that one day there would be a thorough investigation of Russian Lend-Lease. I was only one cog in the machinery. Yet because of the fact that I couldn't know the details of high-level strategy, I began the Jordan diaries...

At this time I knew nothing whatever about the atomic bomb. The words "uranium" and "Manhattan Engineering District" were unknown to me.

THE "BOMB POWDER" FOLDERS

In my capacity as Liaison Officer, I began helping the Russians with necessary paper work and assisted them in telephoning to the various factories to expedite the movement of supplies to catch particular convoys. As Colonel Kotikov communicated with the many different officials in the Soviet Government Purchasing Commission, their names became more and more familiar to me.

Few of the American officers who came in casual contact with the Russians ever got to see any of their records. But the more I helped Rodzevitch and Colonel Kotikov, the more cordial they became. It became customary for me to leaf through their papers to get shipping documents, and to prepare them in folders for quick attention when they reported back to Washington.

At this time I knew nothing whatever about the atomic bomb. The words "uranium" and "Manhattan Engineering District" were unknown to me. But I became aware that certain folders were being held to one side on Colonel Kotikov's desk for the accumulation of a very special chemical plant. In fact, this chemical plant was referred to by Colonel Kotikov as a "bomb powder" factory. By referring to my diary, and checking the items I now know

went into an atomic energy plant, I am able to show the following records, starting with the year 1942 while I was still at Newark. These materials, which are necessary for the creation of an atomic pile, moved to Russia in 1942:

Graphite: natural, flake, lump or chip, costing American taxpayers \$812,437. Over thirteen million dollars' worth of *aluminum tubes* (used in the atomic pile to 'cook' or transmute the uranium into plutonium), the exact amount being \$13,041,152. We sent 834,989 pounds of *cadmium metal* for rods to control the intensity of an atomic pile; the cost was \$781,472. The really secret material, *thorium*, finally showed up and started going through immediately. The amount during 1942 was 13,440 pounds at a cost of \$22,848. (On January 30, 1943 we shipped an additional 11,912 pounds of thorium nitrate to Russia from Philadelphia on the SS *John C. Fremont*. It is significant that there were no shipments in 1944 and 1945, due undoubtedly to General Groves' vigilance.)

It was about this time that the Russians were very anxious to secure more Diesel marine engines which cost about \$17,500 each. They had received around 25 on previous shipments and were moving heaven and earth to get another 25 of the big ones of over 200-horsepower variety. Major General John R. Deane, Chief of our Military Mission in Moscow, had overruled the Russians' request for any Diesel engines because General MacArthur needed them in the South Pacific. But the Russians were undaunted and decided to make an issue of it by going directly to Hopkins who overruled everyone in favor of Russia. In the three-year period, 1942-44, a total of 1,305 of these engines were sent to Russia! They cost \$30,745,947. The engines they had previously received were reported by General Deane and our military observers to be rusting in open storage. It is now perfectly obvious that these Diesels were post-war items, not at all needed for Russia's immediate war activity...

It is true that we never knew the exact use to which *anything* sent under Russian Lend-Lease was put, and the failure to set up a system of accountability is now seen to have been an appalling mistake. But could anything be more foolish than to suppose that the atomic materials we sent were *not* used for an atomic bomb which materialized in Russia long before we expected it? The British let us inspect their installations openly, and exchanged information freely. The Russians did not. Our Government was intent on supplying whatever the Russians asked for, as fast as we could get it to them—and I was one of the expeditors. And when I say "our Government", I mean of course Harry Hopkins, the man in charge of Lend-Lease, and his aides. We in the Army knew where the orders were coming from, and so did the Russians. The "push-button system" worked splendidly; no one knew it better than Colonel Kotikov...

It had become clear, however, that we were not going to stay at Newark much longer. The growing scope of our activities, the expansion of Lend-Lease, the need for more speedy delivery of aircraft to Russia—all these factors were forcing a decision in the direction of air delivery to supplant ship delivery. It had long been obvious that the best route was from Alaska across to Siberia.

From the first, the Russians were reluctant to open the Alaskan-Siberian route. Even before Pearl Harbor, on the occasion of the

first Harriman-Beaverbrook mission to Moscow in September 1941, Averell Harriman had suggested to Stalin that American aircraft could be delivered to the Soviet Union from Alaska through Siberia by American crews. Stalin demurred and said it was "too dangerous a route". It would have brought us, of course, behind the Iron Curtain.

During the Molotov visit to the White House, Secretary of State Cordell Hull handed Harry Hopkins a memorandum with nine items of agenda for the Russians, the first of which was: "The Establishment of an Airplane Ferrying Service From the United States to the Soviet Union Through Alaska and Siberia." When the President brought this up, Molotov observed that it was under advisement, but "he did not as yet know what decision had been reached".

Major General John R. Deane has an ironic comment on Russian procrastination in this regard:

"Before I left for Russia, General Arnold, who could pound the desk and get things done in the United States, had called me to his office, pounded the desk, and told me what he wanted done in the way of improving air transportation between the United States and Russia. He informed me that I was to obtain Russian approval for American operation of air transport planes to Moscow on any of the following routes in order of priority: one, the Alaskan-Siberian route; two, via the United Kingdom and Stockholm; or three, from Tehran to Moscow. I saluted, said 'Yes, sir', and tried for two years to carry out his instructions."

(John R. Deane, *The Strange Alliance*, Viking, 1947, p. 78)

Where the US was not able to force Russia's hand, Nazi submarines succeeded. Subs out of Norway were attacking our Lend-Lease convoys on the Murmansk route, apparently not regarded as "too dangerous a route" for American crews. A disastrous limit was finally reached when, out of one convoy of 34 ships, 21 were lost. The Douglas A-20 Havocs, which were going to the bottom of the ocean, were

more important to Stalin than human lives. So first we started flying medium bombers from South America to Africa, but by the time they got across Africa to Tiflis, due to sandstorms the motors had to be taken down and they were not much use to the Russians. Nor were we able to get enough of them on ships around Africa to fill Russian requirements for the big offensive building up for the battle of Stalingrad.

Finally, Russia sent its OK on the Alaskan-Siberian route. Americans would fly the planes to Fairbanks, Alaska; Americans would set up all the airport facilities in Alaska; Soviet pilots would take over on our soil; Soviet pilots only would fly into Russia.

The chief staging-point in the US was to be Gore Field in Great Falls, Montana. A few years before the war General Ralph Royce, who had been experimenting in cold-weather flying with a group of training planes called "Snow Birds", had found that Great Falls, with its airport 3,665 feet above sea level, on the top of a mesa tableland 300 feet above the city itself, had a remarkable record of more than 300 clear flying days per year, despite its very cold dry climate in the winter.

If you look at a projection of the globe centred on the North Pole, you will see that Great Falls is almost on a direct line with Moscow. This was to be the new and secret Pipeline. The Army called it ALSIB.

But could anything be more foolish than to suppose that the atomic materials we sent were not used for an atomic bomb which materialized in Russia long before we expected it?

WE MOVE TO MONTANA

It was the coldest weather in 25 years when the route was mapped out. First of all, Major General Follette Bradley flew experimentally by way of the old gold-field airstrips of Canada. With the Russians he scratched out a route from Great Falls through Fairbanks, Alaska and across Siberia to Kuibyshev and Moscow. It is the coldest airway in the world across the Yukon to Alaska and through the "Pole of Cold" in Siberia, but it worked.

Colonel (then Captain) Gardner, our trouble-shooter at Newark, was one of the first to go ahead to Montana. Then Lieutenant Thomas J. Cockrell arrived at Great Falls in charge of an advance cadre to make arrangements for the housing and quartering of troops of the 7th Ferrying Group of the Air Transport Command, which was moving from Seattle.

Gore Field was at that time known as the Municipal Airport of Great Falls. Although it had been selected as the home of the 7th, actual construction of barracks and other accommodations had not been started. The Great Falls Civic Center was therefore selected as a temporary home, with headquarters, barracks, mess-hall and other facilities combined under the roof of the huge municipal structure. The Ice Arena was also used as a combination barracks and mess-hall, and temporary headquarters were established in the office of Mayor Ed Shields and the offices of other city officials.

For nearly four months, the Civic Center remained the home of the 7th Ferrying Group, while contractors rushed construction of the barracks, hangars and other buildings which were to make up the post on Gore Field. The group completed its move up to Gore Hill early in November 1942. The 7th Group continued to supervise all stations and operations along the Northwest Route until November 17, 1942, when the Alaskan Wing of the Air Transport Command was established to take over the operations of the route to the north through Canada to Fairbanks, where hundreds of Russian pilots were waiting to take over.

Major Alexander Cohn arrived from Spokane to establish the 34th Sub-Depot for the Air Service Command. It was this depot that supervised the mountains of air freight that originated from all over the United States and poured into the funnel of this end of the Pipeline.

Colonel Gardner arranged for my transfer from Newark to Great Falls. My orders designated me as "United Nations Representative". Few people realize that although the United Nations organization was not set up in San Francisco until September 1945, the name "United Nations" was being used in the Lend-Lease organization as early as 1942, as in my original orders to Newark.

For the record, I want to quote my orders to Great Falls, with one phrase italicized. One reason for this is that in 1949 the *New York Times* printed the following statement of a "spokesman" for the United Nations: "Jordan never worked for the United Nations." I thereupon took the original copy of my orders in per-

son to the *Times*, explained that this was an Army designation as early as 1942, and asked them in fairness to run a correction (which they did not do), since I never claimed to have "worked for the United Nations" and their story left the impression that I was lying. Here are my orders, with the original Army abbreviations [see text box below].

These official orders activating my post were preceded on January 1st by a Presidential directive [see page opposite]. This directive was addressed to the Commanding Generals of the Air Transport, Material, and Air Service Commands, through Colonel H. Ray Paige, Chief, International Section, Air Staff, who worked directly under General Arnold. This directive gave first priority for the planes passing through our station, even over the planes of the United States Air Force! It was extremely important in all my work. I quote from the crucial first paragraph:

"...To implement these directives, the modification, equipment and movement of *Russian planes have been given first priority, even over planes for U.S. Army Air Forces...*"

...The Russian staff had moved from Newark to Great Falls, with Colonel Kotikov still at their head. By this time I was on a very friendly personal basis with the Colonel. As human beings, we got on very well together. From the viewpoint of the usual Russian behavior toward Americans, it could even be said that we were on intimate terms...

THE BLACK SUITCASES

After my return to Great Falls I began to realize an important fact: while we were a pipeline to Russia, Russia was also a pipeline to us.

One really disturbing fact which brought this home to me was that the entry of Soviet personnel into the United States was completely

uncontrolled. Planes were arriving regularly from Moscow with unidentified Russians aboard. I would see them jump off planes, hop over fences, and run for taxicabs. They seemed to know in advance exactly where they were headed, and how to get there. It was an ideal set-up for planting spies in this country, with false identities, for use during and after the war.

It is hard to believe, but in 1943 there was no censorship set-up at Great Falls. An inspector more than 70 years old, named Randolph K. Hardy, did double work for the Treasury Department in customs and immigration. His office, in the city, was four miles from the airfield. He played the organ in a local church, and I was often told he was practicing and could not be interrupted. I took it upon myself to provide him with telephone, typewriter, desk, file cabinet, stenographer, interpreter and staff car.

Finally I was driven to put up a large sign over my own office door, with the legend in Russian and English: "Customs Office—Report Here". When Mr Hardy was not present, I got into the habit of demanding passports myself and jotting down names and particulars. It was not my job, but the list in my diary of Russians operating in this country began to swell by leaps and bounds. In the end I had the 418 names mentioned earlier.

Army Air Forces Headquarters, 34th Sub Depot Air Service Command Office of the Commanding Officer

Capt GEORGE R. JORDAN, 0-468248, AC, having reported for duty this sta per Par 1, SO No. 50, AAF, ASC, Hq New York Air Serv Port Area Comd, Newark Airport, N.J., dated 2 January 43, *is hereby asgd United Nations Representative*, 34th Sub Depot, Great Falls, Montana, effective this date.

By order of
Lt. Colonel MEREDITH.

Despite my private worries, my relations with Colonel Kotikov were excellent. I was doing all that I could do to expedite Russian shipments; my directives were clear, and I was following them out to the best of my ability.

Colonel Kotikov was well aware that a Major could do more expediting than a Captain. I was not too surprised, therefore, to learn that Kotikov had painstakingly dictated in English the following letter to Colonel Gitzinger:

Dear Colonel Gitzinger:

Capt. Jordan work any day here is always with the same people, Sub-Depot Engineering Officer, Major Boaz; 7th Ferrying Group Base Engineering Officer, Major Lawrence; Alaskan Wing Control and Engineering Officer, Major Taylor; Sub-Depot Executive Officer, Major O'Neill; and Base Supply Officer, Major Ramsey.

He is much hindered in his good work by under rank with these officers who he asks for things all time. I ask you to recommend him for equal rank to help Russian movement here.

A. N. KOTIKOV,
Col., U.S.S.R. Representative

When my permission finally came through, the gold oak leaves were pinned on my shoulders by Colonel Kotikov. This occasion was photographed and the picture is reproduced elsewhere in this book.

Now two other occurrences began troubling me. The first was the unusual number of black patent-leather suitcases, bound with white window-sash cord and sealed with red wax, which were coming through on the route to Moscow. The second was the burglary of morphine ampules from half of the 500 first-aid kits in our Gore Field warehouse.

The first black suitcases, six in number, were in the charge of a Russian officer and I passed them without question upon his declaration that they were "personal luggage". But the units mounted to ten, twenty and thirty and at last to standard batches of fifty, which weighed almost two tons and consumed the cargo allotment of an entire plane. The officers were replaced by armed couriers, traveling in pairs, and the excuse for avoiding inspection was changed from "personal luggage" to "diplomatic immunity".

Here were tons of materials proceeding to the Soviet Union, and I had no idea what they were. If interrogated, I should have to plead ignorance.

I began pursuing Colonel Kotikov with queries and protests. He answered with one eternal refrain. The suitcases were of the "highest diplomatic character". I retorted that they were not being sent by the Soviet Embassy but by the Soviet Government Purchasing Commission in Washington. He asserted that, whatever the origin, they were covered by diplomatic immunity. But I am sure he knew that one of these days I would try to search the containers.

They had grown to such importance in the eyes of the Russians that they asked for a locked room. The only door in the warehouse with a lock was that to the compartment in which the first-aid packets were kept. I put it at Colonel Kotikov's disposal. The couriers took turn about. First one and then the other slept on top of the suitcases, while his companion stood guard. Perhaps unjustly, I suspected them of stealing our morphine. They were the only persons left in the storeroom without witnesses.

At four o'clock one cold afternoon in March 1943, Colonel Kotikov said to me: "I want you dinner tonight." Then he doubled the surprise by whisking from his ulster pockets two slender bottles with long, sloping necks. "Vodka!"

HEADQUARTERS ARMY AIR FORCES WASHINGTON

January 1, 1943.

MEMORANDUM FOR THE COMMANDING GENERAL, AIR SERVICE COMMAND:

Subject: Movement of Russian Airplanes.

1. The President has directed that "airplanes be delivered in accordance with protocol schedules by the most expeditious means." To implement these directives, the modification, equipment and movement of *Russian planes have been given first priority, even over planes for U.S. Army Air Forces...*

By Command of
Lieutenant General ARNOLD,

Richard H. Ballard
Colonel, G.S.C.
Assistant Chief of Air Staff, A-4

The invitation was accepted with pleasure and also curiosity. For almost a year now I had associated with Colonel Kotikov and his staff, but I had never dined with them. As a matter of routine they lunched with us at the Officers' Club. But at night they disappeared, wandering off by themselves to other restaurants or the dining-room of the Rainbow Hotel, where they were quartered. So far as I knew, this was the first time they had bidden an American to an evening repast...

At the Officers' Club we had noticed that the Russians were extremely absent-minded about picking up bar checks. These oversights were costing us around \$80 monthly, and we decided to remedy the situation. In the club were several slot-machines, for which the Russians had a passion. We decided to "set aside" one machine to cover their libations. Thanks to the one-armed mechanical bandit, we contrived after all to make them settle for their liquor.

Now, of a sudden, they asked me to dinner and were offering vodka, free, as an allurement. I could not help wondering why. Acting on a hunch, I excused myself from riding to town with Colonel Kotikov in his Pontiac. I decided I would take my staff car, which had a soldier driver; in case of need, I preferred to have mobility. I was directed to join the party at seven o'clock at a restaurant in Great Falls known as "Carolina Pines".

There was not much time, so I hastened to ask our maintenance chief whether the Russians were planning any flights. He answered yes; they had a C-47 staged on the line, preparing to go. It was being warmed up with Nelson heaters—large canvas bags, fed with hot air, which were made to slip over motors and propellers. (Winter temperatures at the airfield could be as severe as at Fairbanks, ranging from 20 to 70 degrees below zero. Oil would sometimes freeze as hard as stone, and two to four hours were required to thaw out an engine.)

The Russians wielded a high hand at the airbase, but I had one power they respected. Though Lend-Lease planes were delivered to them at Great Falls, they were flown by American pilots as far as Fairbanks. No American pilot could leave without clearance, and I had authority to ground any plane at any time. In my absence, permission was given by the Flight Officer of the Day. I called the control tower, gave the number of the restaurant, and issue a positive order that no cargo plane was to be cleared for Russia except by myself.

Occupied by these thoughts, I drove to "Carolina Pines"... The gathering consisted of five Russians and a single American, myself. Colonel Kotikov acted as host, and among the guests was Colonel G. E. Tsvetkov, head of the fighter-pursuit division of the Soviet Purchasing Commission...

With the vodka under our belts, we moved to chairs about the table. But at 8.30, when we were two-thirds finished, the waitress handed me a message in pencil. It notified me to call the control tower at once.

At a public telephone, in the corridor, I learned that the C-47 had warmed up and that a couple of newly-arrived couriers were demanding clearance. Without returning to the dining room, I threw on my great-coat, scuffled down the stairs and ordered the driver to race full speed for the hangars, four miles away.

It was mid-winter in Great Falls. Snow was deep on the ground, and stars glittered frostily in a crystal sky. The temperature that night was about 20 degrees below zero.

As we neared the Lend-Lease plane there loomed up, in its open door, the figure of a burly, barrel-chested Russian. His back was propped against one jamb of the portal. An arm and a leg were stretched across to the opposite side. I clambered up and he tried to stop me by pushing hard with his stomach. I pushed back, ducked under his arm, and stood inside the cabin.

It was dimly lighted by a solitary electric bulb in the dome. Faintly visible was an expanse of black suitcases, with white ropes and seals of crimson wax. On top of them, reclining on one elbow, was a second Russian, slimmer than the first, who sprang



to his feet as I entered. They were mature men, in the forties, and wore beneath leather jackets the inevitable blue suits of Russian civilians. Under each coat, from a shoulder holster, protruded the butt of a pistol.

It had been no more than a guess that a fresh installment of suitcases might be due. My first thought was: "Another bunch of those damn things!" The second was that if I was ever going to open them up, now was as good a time as any. With signs I made the Russians understand what I intended to do.

Promptly they went insane. They danced. They pushed at me with their hands and shrieked over and over the one English word they appeared to know. It was "deplomateek!" I brushed them aside and took from my pocket a metal handle containing a safety razor blade which I carry in preference to a pocket knife.

Sensing its purpose, the lean courier flung himself face down across the suitcases, with arms and legs outspanned to shield as many as possible with his body. I dragged one of the containers from under him, and he leaped up again as I started to saw through the first cord. At this sight their antics and shouts redoubled.

While opening the third suitcase, I had a mental flash that brought sweat to my forehead. The Russians were half mad with fury and terror. They were on both sides of me, in front and behind. Supposing in desperation, one of them shot me in the back?

There would be no American witnesses, and my death could be passed off as a "deplorable accident".

I called a Yank soldier who was on patrol thirty feet away. He crunched over through the snow. Bending down from the plane, I asked whether he had had combat experience. He answered that he had, in the South Pacific. I stooped lower and murmured:

"I'm going to open more of this baggage. I want you to watch these two Russians. Both are armed. I don't expect any trouble. But if one of them aims a gun at me, I want you to let him have it first. Understand?"

After a moment's thought, he looked me in the eye and said, "Sir, is that an order?" I replied that it was an order. He clicked the bolt of his rifle to snap a cartridge into the chamber and brought the weapon to ready. He was tall enough for his head to clear the doorsill. The muzzle was pushed forward to command the interior.

One courier jumped from the plane and sprinted for the hangars, where there were telephones. The other, his face contorted as if to keep from crying, began reknitting the cords I had severed. There was little trouble getting into the suitcases because the Russians had brought the cheapest on the market. They had no locks, but only pairs of clasps. All were consigned to the same address. The entry on the bill of lading read: "Director, Institute of Technical and Economic Information, 47 Chkalovskaya, Moscow 120, U.S.S.R."

I decided to attempt only a spot check—one suitcase, say, in every three. I examined perhaps eighteen out of fifty. Otherwise the search was fairly thorough, as I was looking for morphine. (Incidentally, none was found.) The light was so weak that it was impossible to decipher text without using a flash lamp. I had to take off my gloves, and my fingers grew numb with cold.

"I'm going to open more of this baggage. I want you to watch these two Russians. Both are armed. I don't expect any trouble. But if one of them aims a gun at me, I want you to let him have it first. Understand?"

Continued on page 82

Danny Casolaro vs the 'Octopus' Conspirators

*Suspicious
deaths
surrounding the
Inslaw case
have the
signature of a
secret network
whose mission it
is to subvert
truth and justice
at any cost.*

Part 2

by Kenn Thomas ©1996

Editor/Publisher
Steamshovel Press
PO Box 23715
St Louis, Missouri 63121, USA
Web site address:
<http://www.umsl.edu/~skthoma>

*Arriving just a few minutes before his flight, [Abbie] called me and started talking in a stream as soon as I picked up the phone: "This f***ing truck, this f***ing truck swerved; f***ing truck." I didn't get a chance to ask him what truck. Then, just as suddenly as he'd begun, his tone changed, grew quieter and conspiratorial: "Jack, don't believe anything you might hear on the radio or see in the newspapers tonight. Whatever it is, it's not true."*

(From *Run, Run, Run: The Lives of Abbie Hoffman*, by Jack Hoffman and Daniel Simon, a Jeremy Tarcher/Putnam Book, G. P. Putnam's Sons, New York, 1994, p. 336.)

Investigator Danny Casolaro uncovered a secret network whose sphere of influence extends over everything from computer software piracy to alien hardware conspiracy. In August 1991 he was found dead in a Martinsburg, West Virginia hotel, deep slashes cut in both wrists. Some dismissed his death as the suicide of a disillusioned writer. Others recognised it as a murder, committed as a result of something Casolaro had brushed up against in the course of his research into this cabal, which he called "the Octopus".

MYSTERIOUS INSLAW DEATHS

Danny Casolaro's main informant, Michael Riconosciuto, could claim a dark credibility from the fact that colleagues in his shadowy world continued to fall as Casolaro pursued his investigation.

An attorney from Philadelphia, Dennis Eisman—known as the "Fatal Vision lawyer" because of his involvement in the Jeffrey McDonald case—was in touch with Casolaro and was scheduled to travel to Washington to defend Riconosciuto, planning also to meet with a woman who had evidence of the threat to his client. In April 1991, Eisman was shot dead in his car in Philadelphia. According to one source, just prior to Eisman's death indictments were pending against him and other attorneys for narcotics trafficking and money laundering. The indictments never appeared.

As soon as Michael Riconosciuto found out that Eisman was dead, he called Virginia McCullough, a well-known conspiracy researcher who maintained contact with Casolaro. McCullough says that Riconosciuto was "absolutely panicky in jail". She says that Riconosciuto told her, "They've killed my attorney", and asked her to telephone another attorney, James Guthrie, who was working on his case, to warn him. McCullough did, and Guthrie told her, "I'm out of here."¹

On 1st April 1991, nine days after he issued his affidavit in the Inslaw case, Michael Riconosciuto was arrested by police on one count of distributing methamphetamine, manufactured at Lakebay in Washington state.

Investigators for the Intelligence Committee of the House of Representatives met with Riconosciuto in Tacoma, spent six hours taking depositions from him, and asked him for proof of his statements by way of legal documents. According to one report, Riconosciuto asked for clear "Lawyer-Client Privilege" labelling on documents when he called them in from his attorney, as a precaution against search and seizure by government agencies. Nevertheless, Riconosciuto's jailers opened the privileged packages and refused to forward them. Instead, the report goes on, they contacted the NSA (National Security Agency) which sent a team to review the material. By the end of December 1991, the Agency had still not commented on when the documents would be returned to Riconosciuto.²

Casolaro, who had been conferring with Riconosciuto regularly since late 1989, flew to

Tacoma for the trial and to act as a legal investigator for Riconosciuto for 10 days.³ Their meeting, and the fruitless search for the alleged tape-recording of Peter Videnieks—a Justice Department official who had threatened Riconosciuto on tape over the Inslaw case—may have contributed to a certain disillusionment that Casolaro began to feel about "Danger Man" by the time he returned home. "That guy is nuts," he stated to a journalist after his Washington trip.⁴ No such assessment of Riconosciuto's sanity was needed to determine that his statements were suspect.

In addition to life among the ufonauts, as documented in the last issue of NEXUS (vol. 3, no. 6), Riconosciuto failed to produce an oft-requested passport to corroborate his claimed trips to Iran. When asked by the CNN *Moneyline* program to describe Peter Videnieks—whom he claimed to have met on several occasions and to have been threatened by on the lost tape—Riconosciuto was unable to do so.⁵

On 19th June 1991, four days after Casolaro had an interview with Danger Man, former Nixon campaign aide Alan Michael May died in his home in San Francisco. During the interview, Riconosciuto had talked about May's involvement in the October Surprise. The coroner's initial report attributed May's death to heart attack, but an autopsy showed the presence of polypharmaceuticals in his body.

Anson Ng, a reporter for the *Financial Times* of London, pursued Jimmy Hughes—a guard with Area 51's Wackenhut security service who was central to the Alvarez murder case—to South America in an attempt to get an interview. While in Guatemala during July 1991, Ng was murdered by a single bullet to the chest. His death was ruled a suicide. The Guatemalan Government was asked to retrieve Ng's floppy discs and personal papers regarding his investigation. It did so and turned them over to a US intelligence agency. In a press conference a few weeks later, Senator Alan Cranston requested that these items be returned, but they never were.

More than a year earlier, on 31st March 1990, a British journalist named Jonathan Moyle was found dead, hung in a hotel room closet in Santiago, Chile. "Although Casolaro and Moyle were probing different leads, their investigations involved some of the same people," said columnist Jack Anderson.⁷ Moyle, an editor at London's *Defence Helicopter World*, had been investigating the weapons trade, specifically the alleged sale of non-military US helicopters to Iraq for refitting as attack choppers. The notes Moyle left behind contained reference to a sophisticated missile guidance system that held Iraqi interest, although whether or not Iraq used the system in its disastrous Scud attacks during the Persian Gulf War is unknown. Instrumental in the arms-dealing Moyle had been investigating was Carlos Cardoen, the same man Ari Ben-Menashe identified as the intermediary between Iraq and Earl Brian for the PROMIS software deal.⁸ Initial reports called Moyle's death a suicide, but evidence, including the presence of a strong sedative in his system and possible asphyxiation, suggested otherwise.⁹

It is unclear whether or not Moyle kept contact with Casolaro, although Casolaro's notes include references to Carlos Cardoen and the Iraqi missile deal. Casolaro knew about Alan May and he had also learned about Anson Ng's death shortly after it took place, while he was developing his Octopus thesis. He also remembered the January murder of Alan Standorf. Riconosciuto had introduced Standorf to Casolaro as an electronic intelligence operative of the NSA, working at the Vint Hill military installation in Virginia that gathered information from espionage satellites and other sources throughout the world. Casolaro agreed that Standorf had important information linking the Justice Department to parts of the various scandals he was researching. After Standorf's death, Casolaro mentioned to a friend, Bill Turner, that a key source had vanished.¹⁰

Did Casolaro feel the tentacles tightening? If so, it was not reflected in his research notes. He was collecting information on vicious killers and powerbrokers, but he gave no clue that he thought they were coming after him.

Over time, Michael Riconosciuto lost three lawyers and an investigator under what could be construed as mysterious circumstances. In February 1987 Larry Guerrin, a private investigator conducting Inslaw-connected work for Riconosciuto, was killed in Mason County, Washington. After Eisman's death, in April 1993 John Crawford, another attorney who worked with Riconosciuto, died suddenly of a heart attack in Tacoma.¹¹

The decomposed body of a third Riconosciuto lawyer, Paul Wilcher, was found in Wilcher's Washington, DC apartment on 23rd June 1993.

Wilcher had also been an attorney for the pilot Guenther Russbacher who claimed to have videotape proof and 16 witnesses to his having flown George Bush to one of the October Surprise meetings.¹² Wilcher belonged to the American Patriot Fax Network and had recently prepared an ambitious 155-page fax, summarising information on circumstances leading to the fiery deaths of David Koresh and his follow-

ers in April 1993, that he sent as a challenge to Attorney General Janet Reno. The fax included details of the story of his client, Russbacher, concerning the October Surprise, and a page of information on the Inslaw case, pointing out that an executive assistant to Senator Robert Byrd (Democrat, West Virginia), was the wife of Peter Videnieks who had threatened Riconosciuto.¹³

The mysterious death list also came to include the execution-style slaying of Ian Spiro, his wife and three daughters, in San Diego on 1st November 1992. Spiro reportedly worked for US and British intelligence agencies on operations that included the October Surprise, Iran-Contra and the hostage crisis in Lebanon. Spiro spoke with Riconosciuto, whom he was helping collect documents to present to a grand jury, only a few days before his death.¹⁴

Later, others would begin to develop lists of significant deaths related to the Inslaw case in much the same way. Many began making connections between the deaths of witnesses and others associated with the JFK assassination 25 years earlier. In addition to the Riconosciuto lawyers, the list included Vali Delahanty,

The fax included details of the story of his client, Russbacher, concerning the October Surprise, and a page of information on the Inslaw case, pointing out that an executive assistant to Senator Robert Byrd (Democrat, West Virginia), was the wife of Peter Videnieks who had threatened Riconosciuto.

whose knowledge of a DEA (Drug Enforcement Administration) plan to set up Riconosciuto on a drug charge would have made her an important witness for Riconosciuto. She disappeared on 18th August 1992, but her body was not discovered until the following April in a ravine near Lakebay, Washington.¹⁵ Another Riconosciuto ally, Pete Sandvigen, who was working to help Riconosciuto defend himself against the drug charges, died the following December, an ammo clip from his gun mysteriously missing.¹⁶

Barry Kusnick, a computer engineer who had also worked on PROMIS enhancements, also made the list. According to one report, Kusnick's enhancement was called "Brainstorm", an artificially intelligent program that applied the prognosticating ability of PROMIS to individual thought-patterns. It ostensibly allowed PROMIS to deduce from personality characteristics the potential action of the person being traced. As in the Inslaw case, Kusnick apparently made the modifications under a government contract, but the government failed to pay on it, attempting instead to drive Kusnick into bankruptcy. Kusnick had previously done communications and intelligence work for Northrop Corporation and the US military. His body has never been found, and, nine months after he was reported missing, family members were unable to get a known business partner to acknowledge knowing him. Five boxes of his belongings were found in a lock-up facility.¹⁷

Sherman Skolnick, long-time chairman of Chicago's Citizen's Committee to Clean Up the Courts, charged that nearly 40 witnesses in the Inslaw case had been murdered, and complained that a federal judge appointed to review the case failed to show concern over the safety of other witnesses. He also claimed that a Special Federal Grand Jury in Chicago planned to do an end-run around the judge and issue high-level indictments. Skolnick also reported that three of the grand jury witnesses joined with Riconosciuto to file suit against the judge for obstructing the indictments and for having witnesses interrogated by an FBI agent who himself was suspected of murdering Casolaro.¹⁸

To me, however, the most interesting of all the mysterious deaths connected to Inslaw was that of 1960s political activist Abbie Hoffman. Hoffman wrote an early piece on the October Surprise for *Playboy* magazine and shortly thereafter was involved in a suspicious automobile accident. Most regarded his death on 12th April 1989 as the suicide it was reported to be, due perhaps in part to the depression he suffered from the continuing pain resulting from that accident. Others, however, suspected foul play in Hoffman's death—notably, David Dellinger, a fellow member of the Chicago 8. Dellinger's suspicions even led him to attempt to retrieve the coroner's report for examination, but he was stopped by a threatened court battle. "They basically would not allow that to go to court," Dellinger concluded. "But [Abbie's son] Andrew and Abbie's first wife, Sheila, are convinced that he was killed."¹⁹

"CLARK GABLE"

Bill and Nancy Hamilton, owners of the Inslaw company and PROMIS software that Casolaro

was investigating, acquired another important informant and introduced him to Casolaro who started speaking with him regularly on the telephone.²⁰ This was Robert Booth Nichols, who, Casolaro said in his notes, "looks like Clark Gable".²¹ Nichols presented himself as a dashing, spy-like figure with connections to both the legal and illegal underworld, including the infamous Gambino crime family. He was also someone who had worked at the Cabazon reservation with Riconosciuto. Riconosciuto and Nichols formed a business partnership in the 1970s to manufacture fertiliser, pesticide and weaponry, including fuel-air explosives and the G-77, an inexpensive sub-machine-gun invented by Nichols, but the two had argued in 1984 and have not spoken since.²²

Nichols and Casolaro spoke on the phone 15 times in July—calls which lasted as long as two hours. They met in person at the Four Seasons Hotel in Washington, DC, on 10th July 1991. Casolaro was so impressed with the sophistication and 'insider' knowledge his new friend Nichols had that he also came to consider him a mentor. At one point, Casolaro spoke to him about his money troubles and Nichols offered financial assistance—in exchange for a 25 per cent interest in Casolaro's home and right of first refusal if he sold it.²³

To tempt a girlfriend, Wendy Weaver, into accompanying him to his meeting with Nichols at the Four Seasons, Casolaro described him as the president of the Bechtel Corporation who had just arrived from Kuwait. Nichols intimated at the dinner party that he was going to be named state security minister of the Caribbean island of Dominica, which would become a centre for rebuilding Kuwait. He also repeated his warnings to Casolaro that the matters the journalist was delving into were dangerous. Weaver recalls that Nichols warned Casolaro at least five times about the danger of associating with Riconosciuto, and that if Casolaro said anything that went against Nichols' former partner Riconosciuto, he would be killed. At one point during the evening, responding to a slight from another patron at the bar that Weaver later described as imagined, Nichols grabbed the man, slammed him against the wall and declared that he would kill him. Later that evening, Casolaro confided to Weaver that Nichols "really scared him". In his notes, Danny Casolaro characterised Nichols as "very powerful".²⁴

On another night, Casolaro and a different friend met Nichols at



Michael Riconosciuto

Clyde's in Tyson's Corner, Washington, DC. Nichols was again talking about Dominica, saying that he had just done a radio broadcast in his new position as minister of state security, and also that he was part of a CIA coup that was going to happen. Casolaro's friend claimed that Nichols "had this story that they were going to turn Dominica into a CIA base, had plans for a desalination program, and pulled out this design drawn by a French architect of a dome the size of Texas Stadium that was half underwater. Really, the whole thing reminded me of Ernst Stavro Blofeld..."

After dinner, Casolaro took his friend aside and showed him what he alleged was a summary of an FBI wiretap on Nichols that linked him to the Yakuza and the Gambino family. Casolaro's friend was shocked. "I said, 'Danny, I'm gonna take you out back and whip your ass! You just put me in a meeting with this man and didn't tell me what the hell...why didn't you tell me before?' And Danny was kind of, 'Oh, I don't know. I wanted to see how Nichols would react...'"²⁵

Danny Casolaro related Nichols' stories about Dominica in his notes: "Before the reins of the Octopus are turned over to several younger players, the game continues now—July 1991—on the tiny Caribbean island nation of Dominica. Possessing the largest boiling deep-water lake in the world, Dominica's geothermal potential is unmatched. It is here that the Octopus may be making its boldest and most dangerous move yet."²⁶

In 1976 Nichols represented a Saudi company, Ali & Fahd, in a failed attempt to acquire Howard Hughes' Summa Corporation after the death of the reclusive magnate. Joseph Cicippio, later taken as a hostage in Lebanon, was an employee of Ali & Fahd at the time, and has stated that Nichols represented himself as an agent for the US Government in the takeover bid. Cicippio said that Nichols showed him Justice Department identification, and had information which he assumed could only have been obtained through government contacts. Possession of such identification from the Justice Department suggests a possible link between Nichols and the original PROMIS double-dealings.²⁷

Casolaro learned more about Nichols from Richard Stavin, formerly a special prosecutor for the Justice Department's Organized Crime Strike Force who had some familiarity with the small-eared Gable's attachment to the mob-end of the entertainment industry. On 31st July 1991, Stavin explained to Casolaro the connections Nichols had to the Gambinos and the Yakuza, which the FBI had investigated in 1987 as part of its probe of Mafia presence in Hollywood. Stavin also mentioned that Nichols had at one time offered to become an informant for the Justice Department, although he did not know whether anyone had taken him up on the offer. Today, Stavin feels that passing this information on may have contributed to Casolaro's death.²⁸

The FBI's focus in 1987 was on mob influence in the motion picture industry, taking particular aim at Eugene Giaquinto, a member of the board of directors of Nichols' Meridian Arms, a firm that was to manufacture the G-77 gun in South Korea. At the

time, Giaquinto also served as president of the home entertainment sector of MCA, which owned Universal Pictures. In his application to wiretap Giaquinto, Agent Thomas G. Gates, who later supplied information to Casolaro, suggested that FBI investigative files indicated that in 1978 Nichols had been "an international money launderer for money generated through narcotics trafficking and organized crime activities."²⁹ The wiretaps caught Giaquinto and Nichols discussing a takeover of MCA, and revealed Giaquinto's connection to renowned mobster John Gotti. Although the investigation was derailed by members of the Reagan administration, Giaquinto left both MCA and Meridian, but not before unsuccessfully trying to secure an appointment for Nichols to head an industry anti-video-piracy operation in Asia.

Nichols denied any involvement with the Yakuza or the Mafia. "He traces the trouble to an FBI misunderstanding of his screenplay career. He says he was introduced to a high-level executive of MCA several years ago at a coffee shop. When the MCA man encouraged him to turn some tales he'd told him into screenplays, they became friends and, briefly, business associates. Unknown to him, the MCA man was the subject of a full-court-press FBI investigation for being a key organized-crime link to the entertainment industry. And so, Gable [i.e., Nichols] says his voice was picked up by taps on the MCA man's phone. The bureau misinterpreted their conversations as containing code words for illegal activities, turned around, targeted him, and slandered him to his business associates.

In fact, Gable's company is suing an FBI man for libel and slander. He says that the wiretap summary was part of the FBI man's affidavit in the Gable slander suit."³⁰

Nichols responded to an affidavit by Agent Gates, linking him to John Gotti and the Gambino family through Giaquinto by suing him and the US Government for libel—suits which were dismissed twice by federal courts. Gates said in testimony before the House Judiciary Committee that Nichols' attempts at payback may not have ceased: informants had twice told

him that Nichols had placed a contract on his life.

The other high point of Nichols' movie career came with his cameo appearance as a terrorist in the 1992 Steven Seagal movie, *Under Siege*. Perhaps not coincidentally, Seagal became embroiled in controversy when a writer, Alan Richman, claimed in *GQ* magazine that Seagal had appropriated details of the biographies of former associates Robert Strickland and Gary Goldman and passed them off as incidents in his own life. When investigator John Connolly later repeated the charges in *Spy* magazine and made further claims that Seagal tried to set up Richman in a fake homosexual tryst and tried to have Goldman killed, Seagal sued unsuccessfully.

In 1993 Nichols sought damages against the Los Angeles Police Department over an incident that caused the revocation of his concealed weapons permit and, consequently, a money pullout by Swiss financiers for manufacturing the G-77. According to his testimony, he had been thrown to the floor, disarmed, handcuffed and carted off to a North Hollywood jail by LAPD officers

To me, however, the most interesting of all the mysterious deaths connected to Inslaw was that of 1960s political activist Abbie Hoffman.

Hoffman wrote an early piece on the October Surprise for *Playboy* magazine and shortly thereafter was involved in a suspicious automobile accident.

responding to a disturbance complaint at a club called The Palomino—another pale horse.³¹ Nichols said he was not involved in any disturbance but had only stopped in at the club for a couple of beers. Further testimony and legal documents reflected an impressive list of former business partners, including Howard Hughes cohort Robert Maheu and Texas oil magnate Clint Murchison.³²

Casolaro may not have understood the possible danger of possessing the information he had learned from Richard Stavin—that Nichols may have offered himself as a government stool-pigeon—or of mentioning what he knew to Nichols. If word of his association with the Mafia and the Yakuza did leak out during their conversation, he may have perceived such information as being very dangerous personally. Six days after talking to Stavin, Casolaro spoke again with Nichols. The following day, Casolaro informed Stavin that Nichols had warned him off the investigation. Apparently, this time the warning bothered Casolaro. If he did reveal to Nichols what he had learned, he may have portrayed the information as being unearthed by his own investigations, not Stavin's. At about the same time, he called FBI Agent Thomas Gates and asked whether he should take seriously Nichols' warning that, "If you continue this investigation, you will die." Despite this, Gates characterised Casolaro as "upbeat, not like a person contemplating suicide".

SEA CREATURE SURFACING

On 8th May 1991, the Inslaw case was overturned on second appeal, on the technicality that it should not have been tried in Bankruptcy Court. The ruling came on the day before the Justice Department would have had to release all of its software to the Hamiltons.³³ The Hamiltons asked the Supreme Court to hear the case in October.³⁴

In mid-June 1991, Danny Casolaro met with Jeff Steinberg, the Lyndon Larouche aide. Steinberg, who had earlier arranged the contact between the Hamiltons and Michael Riconosciuto, arranged this time for Casolaro to talk to an informant who went by the odd name of CHIPS—a former Customs agent who was now assisting the Treasury Department. Steinberg believes that CHIPS turned Casolaro's investigations further in the direction of Robert Booth Nichols and toward the Gambino Mafia family and drug trafficking.

Shortly thereafter, Casolaro made phone contact with E. Howard Hunt³⁵—a name that appeared on the 'A' list of many conspiracy researchers. Of late, Hunt had made a career writing

bad spy fiction, but his infamy stretched back to his role as one of the Watergate burglars and well before. Hunt had brought and lost a defamation case against accusations that he had been involved in the JFK assassination.³⁶ Like Fred Crisman, the associate of Riconosciuto's father, Hunt had been identified as one of the JFK railroad tramps,³⁷ and one former marine chum of Lee Harvey Oswald suggested that Hunt's role in the assassination involved brain implant technology.³⁸ Even without that distinction, Hunt certainly had been active in spook projects of the Kennedy era, most notably in the failed Bay of Pigs invasion. Even as Casolaro developed a "cordial, even effusive" relationship with Hunt,³⁹ he was taking notes.

... Steinberg observed that by this time Casolaro had followed the trail of the Inslaw and related stories "back to a dirty CIA 'Old Boy' network" that had begun working together in the 1950s around covert operations in Albania.

In a memo, Steinberg observed that by this time Casolaro had followed the trail of the Inslaw and related stories "back to a dirty CIA 'Old Boy' network" that had begun working together in the 1950s around covert operations in Albania. These men had gotten into the illegal gun and drug trade back then and have continued in that business ever since.

Martin Killian, a Washington correspondent for *Der Spiegel*, also

spoke to Casolaro about the conspiratorial entity that Casolaro was by now calling "the Octopus"—a cabal which Casolaro believed had been started by CIA superspook James Jesus Angleton. Casolaro believed that the motive for creating the Octopus had been revenge for the notorious Albanian operation which had been compromised by Soviet mole Kim Philby.⁴⁰ Tony Casolaro said that his brother did not see the Octopus as a tightly-structured organisation. "He didn't envision them as a group like the Mafia. More as a network. They would overlap when their needs coincided."

The view reflected in Casolaro's notes was that "This is the Octopus whose defensive posture could reap havoc anywhere in the world. Indeed, what you will learn in this true crime narrative is a massive unraveling of modern history's most incredible puzzles."⁴¹

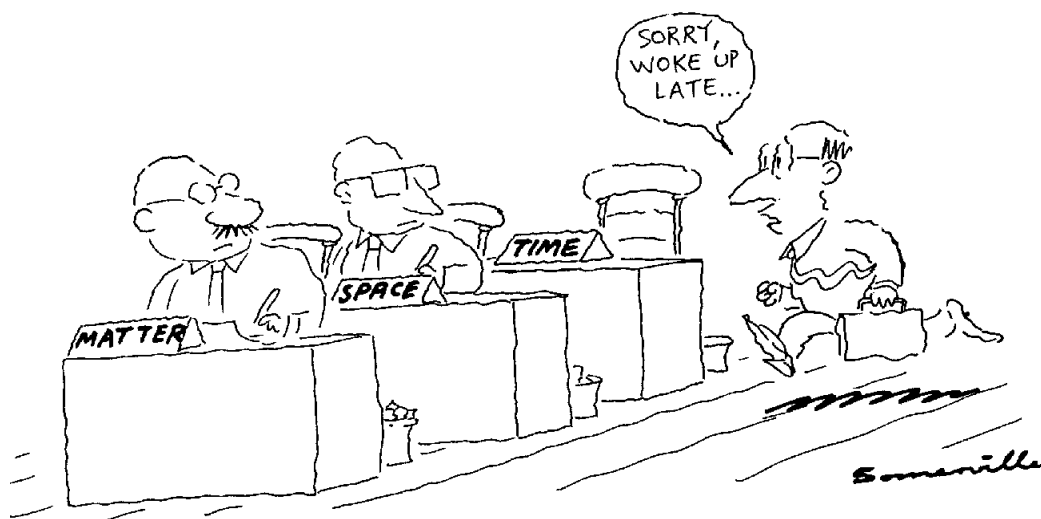

Endnotes

- ¹ Virginia McCullough, interviewed by Kenn Thomas, 27 January 1994.
- ² "The Com-12 Briefing", *Phoenix Liberator*, 23 March 1993, p. 20.
- ³(a) Ridgeway, James and Vaughan, Doug, "The Last Days of Danny Casolaro", *Village Voice*, 15 October 1991, p. 34;
- (b) "Worldwide Conspiracy or Fantasy?", *Seattle Times*, 29 August 1991.
- ⁴ Ridgeway and Vaughan, p. 35.
- ⁵ Brown, Colin, "CIA Computer Genius Alleges Massive Conspiracy", *Technical Consultant*, December 1990-January 1991, p. 7.
- ⁶ Anderson, Jack and Van Atta, Dale, "Another Casualty in the 'Octopus' Case", *Washington Post*, 28 August 1991.
- ⁷ Anderson and Van Atta, *ibid.*
- ⁸ Ben-Menashe, Ari, *Profits of War*, Sheridan Square, New York, 1992, p. 239, *passim*.
- ⁹ Dalrymple, James, "The Riddle of Room 1406", *The Sunday Times*, London, 30 December 1990.
- ¹⁰ Stich, Rodney, *Defrauding America*, Diablo Western Press, Alamo, California, 1993, p. 407.
- ¹¹ *ibid.*
- ¹² Guenther Russbacher, interviewed by Alex Horvat and Joe Palermo, 17 March 1993.
- ¹³ Wilcher, Paul, American Patriot Fax Network, fax, 21 May 1993, p. 69.
- ¹⁴ Thomas, Kenn, "Inslaw Revisited", *Steamshovel Press*, no. 9, Fall 1993, p. 44.
- ¹⁵ Stich, *ibid.*
- ¹⁶ *ibid.*
- ¹⁷ "Inslaw", *The Leading Edge*, p. 48 (undated).
- ¹⁸ Skolnick, Sherman, "Obstruction of Justice Charged in Inslaw Special Grand Jury in Chicago", privately published paper, 1993.
- ¹⁹ Thomas, Kenn, "King Co-Opted; Abbie Assassinated: An Interview with Dave Dellinger", *Steamshovel Press*, no. 9, Fall 1993, p. 7.

- ²⁰ Connolly, John, "Dead Right", *Spy*, January 1993. Writer John Connolly cast suspicion on the relationship between Bill Hamilton and Robert Booth Nichols: "...despite Hamilton's reservations about Nichols' character, the man who designed a program for tracking criminals and the man who has been linked by the FBI to two crime organizations communicate with surprising frequency. Last summer I visited Hamilton's office in Washington to get a copy of the phone records that would show his call to Nichols on August 9, 1991. He seemed reluctant. It took a fair amount of persuasion to convince him to turn it over—and what he gave me was a photocopy with all but that call blocked out. Shortly after leaving, I remembered that I had wanted to ask him something else and returned to his office. While I was waiting in the reception area, the phone rang. The receptionist buzzed Hamilton: 'Robert Booth Nichols, returning your call.' When I asked Hamilton about the call, he replied, 'I call Nichols all the time. It was just a coincidence that it was right after you left.'"
- ²¹ Gable "without the ears", Ridgeway and Vaughan, *ibid.*
- ²² Corn, David, "The Dark World of Danny Casolaro", *The Nation*, 28 October 1991.
- ²³ Ridgeway and Vaughan, p. 36.
- ²⁴(a) Connolly, *ibid.*;
- (b) Ridgeway and Vaughan, *ibid.*
- ²⁵ Rosenbaum, "The Strange Death of Danny Casolaro", *Vanity Fair*, vol. 54, December 1991.
- ²⁶ Casolaro's notes, pp. 1-7.
- ²⁷ From Casolaro's notes: "Sworn affidavit alleges that Nichols gets word from Justice Department."
- ²⁸ "Unanswered Questions on Casolaro", *The Spotlight*, 28 September 1992.
- ²⁹ Corn, *ibid.*
- ³⁰ Rosenbaum, p. 96.
- ³¹ From Casolaro's notes: "A Palomino is a Pale Horse."
- ³² Weinstein, Henry and Feldman, Paul, "Trial Offers Murky Peek into World of Intrigue", *Los Angeles*

Times, 21 March 1993.

- ³³ DiRienzo, "Shadow Justice", *Unclassified*, vol. 3, no. 3, 1991, p. 8.
- ³⁴ Linsalata, Phil, "The Octopus Files", *Columbia Journalism Review*, November-December 1991, p. 76.
- ³⁵ Ridgeway and Vaughan, p. 35.
- ³⁶ Lane, Mark, *Plausible Denial*, Thunder's Mouth, New York, 1992.
- ³⁷ Groden, Robert, *The Killing of a President*, Viking Studio Books, New York, 1993.
- ³⁸ Interview with Kerry Thornley, *Steamshovel Press*, no. 5, Summer 1992, p. 17. It should be noted that the medical examination of Danny Casolaro's body indicated a scar on his hairline. A year and a half before his death, a friend had found Casolaro with a bloody towel wrapped around his head. Casolaro claimed that barbells had hit him while he was exercising. Ridgeway and Vaughan suggested it might have been due to motor impairment caused by undiagnosed multiple sclerosis.
- ³⁹ Ridgeway and Vaughan, *ibid.*
- ⁴⁰ *ibid.*
- ⁴¹ Casolaro's notes.

This two-part article draws on material covered in the new book, *The Octopus: Secret Government and the Death of Danny Casolaro*, which is based on what was left of Casolaro's work as well as new research. Co-written by Kenn Thomas and Jim Keith, the book is available from Feral House, PO Box 3466, Portland, OR 97208, USA. Kenn Thomas publishes *Steamshovel Press*, a journal that regularly examines conspiracy theories. Single issues: US\$5.50 in USA; US\$6.50 foreign. Subscriptions: US\$22.00 in USA; US\$26.00 foreign. Send to *Steamshovel Press*, PO Box 23715, St Louis, MO 63121, USA. On the web, *Steamshovel* can be found at: <http://www.umsl.edu/~skthoma>

COLLOIDAL SILVER

The Universal Germicide

*Through the ages,
silver has been
used to fight
disease-causing
organisms.*

*Some think it has
a bright future for
treating a
multitude of
medical
conditions
including AIDS
and cancer.*

Compiled from a selection of articles
downloaded from the Internet, including:
"Colloidal Silver: The Amazing
Alternative to Antibiotics"
© The Association for Advanced Colloidal
Research
and "Colloidal Silver: The Natural
Antibiotic Alternative"
© by Zane Baranowski

HISTORICAL BACKGROUND AND RESEARCH

Silver has long been known for its special properties. The people of ancient Greece and Rome used silver containers for keeping liquids fresh. Through the centuries, royal households carried on this practice by storing their provisions in silver containers. Privileged family members used silver eating utensils; they had their meals served on silver plates and their drinks served in silver cups. Indeed, the skin of 'blue bloods' reportedly had a bluish tinge due to the minute traces of pure metallic silver they regularly consumed. In American pioneering days, new settlers travelling to the West would put silver dollars in their milk to delay spoiling.

By the turn of the 20th century, silver was regarded as a proven germ-fighter. In medicine, a solution known as Colloidal Silver was commonly used as a mainstay of antibacterial treatment. Although considered to be 'high tech' at that time, the type of solution was technically inferior compared to today's colloidal silver solutions. One of the drawbacks was that the particle size of the silver never reached its optimum ultramicroscopic size and thus its highest level of efficacy.

Back then, highly effective colloidal silver was very expensive to produce. The pharmaceutical industry wanted faster-working drugs that were cheaper and patentable. In addition, when manufactured improperly, or taken at hundreds of times the proper dosage with extraneous silver compounds included, a permanent skin discolouration, called argyria, could result. For these reasons, colloidal silver fell out of favour. Even so, such prestigious journals as the *New England Journal of Medicine* and the *Lancet* (1914) published the results of scientific studies and examined the many successful uses of colloidal silver.

In 1910, Dr Henry Crooks, a pioneer in colloidal chemistry, wrote that:

"...certain metals, when in a colloidal state, have a highly germicidal action but are quite harmless to human beings...it may be applied in a much more concentrated form and with better results... Bronchial tuberculosis...*Staphylococcus pyogenes*, various *Streptococci* and other pathogenic organisms are all killed in three to four minutes; in fact, no microbe is known that is not killed by this colloid in laboratory experiments in six minutes, [and] the concentration of the [silver] does not exceed twenty-five parts per million..."

In 1919, Alfred Searle, founder of the pharmaceutical conglomerate of the same name, wrote in his book, *The Use of Colloids in Health and Disease*, that:

"...applying colloidal silver to human subjects has been done in a large number of cases with astonishingly successful results. For internal administration, orally or hypodermically it has the advantage of being rapidly fatal to parasites without toxic action on its host. It is quite stable."

COLLOIDAL SILVER REAPPRAISED

Much later, in the 1970s, colloidal silver once again became a valued substance. Doctors at Washington University in St Louis, Missouri, stumbled upon it while searching for effective treatments for burns victims, having tried many other medicines.

Biomedical research has shown that no known disease-causing organism—bacteria, virus or fungus—can live for more than a few minutes in the presence of even minute traces of metallic silver.

Jim Powell reported in an article, "Our Mightiest Germ Fighter", published in *Science Digest* (March 1978, pp. 59-60):

"Thanks to eye-opening research, silver is emerging as a wonder of modern medicine.

An antibiotic kills perhaps a half-dozen different disease organisms, but silver kills some 650. What's more, resistant strains fail to develop when using silver. Moreover, silver is virtually non-toxic."

Larry C. Ford, M.D., of the Department of Obstetrics and Gynecology at the UCLA School of Medicine's Center for the Health Sciences, reported in a November 1988 letter:

"I tested them [the silver solutions] using standard antimicrobial tests for disinfectants. The silver solutions were anti-bacterial for concentrations of 10 organisms per ml of *Streptococcus pyogenes*, *Staphylococcus aureus*, *Neisseria genorrhoeae*, *Gardnerella*, *Vaginalis*, *Salmonella typhi*, and other enteric pathogens, and fungicidal for *Candida albicans*, *Candida globata*, and *M. furfur*."

Biomedical researcher Robert O. Becker, M.D., from Syracuse University, has reported that "Silver stimulates bone-forming cells into growing new bone where it had not healed for long periods of time." Dr Becker is the author of *The Body Electric* and *Cross Currents*, and is also known for his work in regenerating the amputated limbs of bullfrogs.

According to Dr Becker, "Silver did more than kill disease-causing organisms. It promoted major growth of bone and accelerated the healing of injured tissues by over 50 per cent." In his research he discovered cell types that looked just like the active bone marrow of children. "These cells grew fast," he wrote, "producing a diverse and surprising assortment of primitive cell forms able to multiply at a great rate, then differentiate into the specific cells of an organ or tissue that had been injured, even in patients over fifty years old. This ability overcomes the main problem of mammalian regeneration."

Dr Becker also discovered that silver "profoundly stimulates healing in skin and other soft tissues in a way unlike any known natural process...and kills the most stubborn infections of all kinds, including surrounding bacteria and fungus." He concluded that, "What we have actually done was rediscover the fact that silver killed bacteria, which had been known for centuries...; when antibiotics were discovered, clinical uses for silver as an antibiotic were discarded."

COLLOIDAL CHEMISTRY

The term "colloid" refers to a substance that consists of ultra-fine particles that do not dissolve but remain in suspension dispersed in a continuous medium. These ultra-fine particles consist of many atoms or molecules of the original material, but so small they cannot be seen by the naked eye.

Not all types of colloidal silver are 'true' colloids. Properly manufactured colloidal silver is a liquid solution consisting of a minuscule number (3 to 5 parts per million) of sub-microscopic particles of silver, held in suspension in pure water by a tiny electrical charge placed on each particle.

In a 'true' colloid of silver, the ideal size of the silver particles falls within the range of 0.005 to 0.015 microns in diameter. The particles are animated by what is known as Brownian movement, which keeps them in suspension almost indefinitely. You could fit 1,000,000,000 of these submicroscopic particles into a cube that measures four one-hundredths of an inch or 250 thousandths to 25 millionths of an inch.

PRODUCTION METHODS

Many methods were used to produce colloids in the early 1900s—most commonly, the grind process and the electrocolloidal process.

The main drawback to the grind method is that the silver particles are so large that they settle towards the bottom of the solution and much of the colloid's value is lost. To offset this problem, some manufacturers add a stabiliser. By so doing, the silver particles tend to settle to the bottom much more slowly. Typically, the stabiliser used is a protein. The use of a stabiliser tends to disturb the charge on the silver particles, thereby blocking their action and reducing their effectiveness. A 'true' colloid does not require an artificial stabiliser or additive of any kind.

In recent years, the chemical process has been widely employed to replace the grind method. The chemical method provides a convenient shortcut, but it, too, falls short of the superior quality of 'true' colloidal silver. The reaction used is the reduction of a solution of a silver salt. The problem with using chemicals to produce colloids is the difficulty in getting them back out of the solution. These are powerful acid solutions which can cause negative side-effects in the consumer. Also, the use of chemicals has been shown to affect the overall pH of the solution. Typically, a chemical-produced colloid of silver is quite acidic, having a pH of 4.5 to 5.5, while a 'true' colloid of silver has a pH in the range of 6.5.

The electrocolloidal process allows extremely fine silver particles to be suspended in solution by the tiny charge placed on the particles. It is done by striking an electric arc between poles made of the metal, under water. If done properly, this method replaces the need for any chemicals, stabilisers or proteins, so the product can be called a 'true' colloid of silver. However, much of the efficacy of the colloidal solution depends on the actual size and uniformity of silver particles. Particles that are too large may cause harm by lodging in the fine lining of the digestive tract and causing scar tissue to form.

COLOUR

A critical indicator of the quality of colloidal silver is colour. As the size of each silver particle gets larger, the colour of the solution ranges from yellow to brown to red to grey to black.

Colloids of silver that are produced using the proper electrocolloidal method are a different colour than the grind- or chemically-produced colloids, except in the case of some products that contain artificial food colouring to get the right colour. The ideal form of colloidal silver is a golden yellow colour.

BIOCHEMISTRY

Medical researcher Dr Gary Smith suggests that silver may be linked to the proper functioning of the body's natural defence system and that people with an inadequate intake may be more prone to illness.

Medical tests indicate no known adverse effects from the use of properly prepared colloidal silver. Indeed, there has never been a recorded case of adverse interaction with any other medication.

Some lab tests have shown that 'true' colloidal silver in the range of 3 to 5 ppm (parts per million) has little effect on 'friendly' bacteria, while being highly useful against infections and in eliminating various microbes, viruses and fungi. Colloidal silver that is too concentrated (above 5 ppm) may upset the delicate balance of the digestive tract by destroying significant amounts of friendly bacteria.

With a 98 per cent uptake rate, colloidal minerals are much more easily assimilated compared to mineral supplements derived from crushed and processed clay, rocks and soil. And unlike many vitamin and mineral supplements where a higher concentration is sometimes more beneficial, with colloidal silver an excess in quantity does not mean more quality. In fact, the opposite is true.

FDA EVALUATION

A number of forms of colloidal silver have been officially recognised as pre-1938 drugs by the US Food & Drug Administration (FDA). However, not all forms listed were true colloids of silver because the size of the particles and the effectiveness varied markedly.

The FDA's Center for Drug Evaluation and Research has stated:

"Colloidal silver is considered to be a pre-1938 drug. These products may continue to be marketed without submitted evidence of safety and effectiveness [required of all drugs marketed after 1938] as long as they are advertised and labeled for the same use as in 1938 and as long as they are manufactured in the original manner."

COLLOIDAL SILVER TREATMENT

Colloidal silver is tasteless, odourless and non-stinging to sensitive tissues. It may be taken orally, as well as put on a Band-Aid and applied directly to cuts, scrapes, open sores and warts.

It may also be used as a rinse for acne, eczema and other skin irritations. It can be gargled, dropped into eyes and ears, used vaginally and anally, as well as atomised and inhaled into the nose or lungs.

The following is a partial list of the more than 650 diseases that have been successfully treated with colloidal silver:

- Acne • Anthrax • Appendicitis • Arthritis • Athlete's Foot
- Bacterial infections • Bladder infections • Blood poisoning
- Boils • Burns
- Cancer • *Candida albicans* • Catarrh • Chronic Fatigue Syndrome • Colitis
- Conjunctivitis • *Cryptosporidium* infection • Cystitis
- Dermatitis • Diabetes • Diarrhoea • Diphtheria • Dysentery
- Ear infection • Eczema • Epstein Barr virus • Eustachian tube infection

- Fibrositis
- Gastritis • Gonorrhoea
- Haemorrhoids • Herpes virus
- Impetigo • Influenza • Intestinal disorders
- Keratitis
- Legionnaire's disease • Leprosy
- Lesions • Lupus
- Malaria • Ménière's disease • Meningitis
- Neurasthenia
- Ophthalmia
- Paratyphoid fever • Pleurisy • Pneumonia • Polio virus
- Prostate disorders • Pruritis ani • Psoriasis • Pyorrhoea
- Rheumatism • Rhinitis • Ringworm • Rosacea
- *Salmonella* infection • Scarlet fever • Seborrhoea
- Septicaemia • Septic ulcers • Shingles
- Skin cancer • Sores • *Staphylococcus* infection
- *Streptococcus* infection • Sunburn • Syphilis
- Tetanus • Tonsillitis • Trenchfoot • Tuberculosis • Typhoid
- Ulcers
- Warts • Whooping cough
- Yeast infections

MORE CLINICAL EVIDENCE

"A 65-year-old diabetic cut himself on the leg. He washed and bandaged it but, as often happens with diabetes, the pain persisted, and the cut grew into a sore. Soon it became bigger than the bandage, and he had to apply a dressing. Still it grew bigger and uglier. In desperation he went to a clinic. His sore was diagnosed as a 'stasis ulcer'. For a year, one treatment after another was tried. Nothing, including penicillin and sulfonamide, could heal the ulcer. If his condition had continued unchecked, his leg probably would have been amputated. But finally he was referred to a clinic that treated skin ulcers with a silver compound. This promptly stopped the growth of all bacteria. In less than two months, the ulcer was completely healed."

(*Science Digest*, March 1978)

"We have had instant success with colloidal silver and immune-compromised patients. A few examples are: pink-eye totally resolved in less than six hours (topical); recurrent sinus infections resolved in eight days (oral ingestion); acute cuticle infections, twenty-four hours (topical). Another major area in which we have improved our clinical results is in the area of bowel detoxification and dysbiosis. The colloidal silver has provided excellent removal of abnormal intestinal bacteria; also it has proved to be a great adjunct to our *Candida albicans*, Epstein Barr virus and Chronic Fatigue Syndrome protocols." (Dr Evan M., Kansas)

"Success depends on the amount of silver in the person's body, and problems result from the lack of silver in the body. When silver is present, the cancer cells stop their development and the body is basically restored. When silver levels are low or non-existent, the cancer growth rate slows or continues to grow because the cells cannot reverse themselves."

"One might ask, how do we get silver in our body in the first place? We get silver and all minerals in the body through the food we eat. How does silver get in the food? It gets in the food through living soil...where living organisms in humus soil (there are billions in a handful of dirt) break down the soil so plants are provided minerals in a form assimilable to the plant.

"By assimilating the plant nutrients, the minerals are transferred in our digestive tract where our bodies utilise the captured organic (chelated) minerals through the bloodstream to the various organs of our body. Hence, we get silver from plants.

"If we cannot assimilate silver for some reason or as the tissues age, we develop a silver deficiency and an impaired immune system, leading to cancer in most cases. I suspect a silver deficiency is possibly one of the main reasons cancer exists and is increasing at such a rapid rate."

(Cancer researcher Dr Gary Smith, writing in an unpublished article)

WHO'S USING COLLOIDAL SILVER?

- In Canada, Switzerland and the US, physicians use various forms of silver to treat a multitude of infections.
- In the US, silver is used in bone surgery and in 70 per cent of US burns centres.
- Naturopaths and chiropractors use colloidal silver to treat the effects of *Cryptosporidium*. Ayurvedic, Chinese and homoeopathic practitioners also regularly use silver in their treatments.
- Swiss biochemists are studying silver's ability to interrupt the cellular replication of HIV at various stages.
- Colloidal silver water-filters are approved by the US Environmental Protection Agency and also by the Swiss government for use in homes and offices.
- The American space agency NASA uses a silver water-purification system for its space shuttles; so do the Russians.
- The airline companies Air France, Alitalia, British Airways, Canadian Pacific, Japan Air Lines, KLM, Lufthansa, Olympic, Pan Am, SAS and Swissair use silver water-filters to curtail waterborne diseases.
- Silver is often used in place of chlorine in swimming pools because it doesn't sting the eyes.
- Japanese companies are using silver to remove cyanide and nitric oxide from the air.

Sound Treatments for Good Health

Vibration permeates everything, and sound affects everybody, whether we realise it or not.

Here, we explore two approaches to the use of sound in improving health.

Based on material supplied by

**Kay Distel
Sound Education (Australia)**

3 Couatts Place, Melba, ACT 2615

Phone: (06) 259 1364

Fax: (06) 258 5530

1. THE TOMATIS® METHOD GETS A WIDER HEARING

How seriously should we take the modern menace of noise pollution? Last year (1991), environmental health officers in Britain received over 100,000 complaints about noise, while the US National Institute of Health estimated that more than 10 million Americans are regularly exposed to noise levels that could cause hearing loss, with discos and personal stereo systems the chief causes for concern. Potentially most harmful, therefore, are the 'recreation' sounds we purposely seek and depend on for pleasure and escape, or the everyday urban cacophony to which we eventually become impervious. As Professor Chris Rice, Director of the Institute of Sound and Vibration Research in Southampton, points out, the real danger is that "you don't become accustomed to noise, you become deaf to it." And if not deaf, then functionally impaired in other subtle, less obvious ways.

According to Europe's leading pioneer in the field of Audio-Psycho Phonology (APP)—the study of the relationship between ear, voice and psyche—although hearing is probably the first of our senses to develop, it remains the least researched and understood and is taken largely for granted by all except those with diagnosed hearing problems. Yet having devoted a lifetime to analysing and improving the function of the human ear, Professor Alfred Tomatis concludes that the most powerfully far-reaching of all the senses generally remains the most defective.

The eponymous Tomatis 'method' seems at first to be informed as much by New Age philosophy as medical science. The apparent unorthodoxy of some of Tomatis's views—for instance, that from four-and-a-half months the foetus begins listening to its mother's voice, distinguishing it from the background of visceral rumblings, and becomes dependent on an intra-uterine 'dialogue' which then develops throughout infancy—belies his background as a practising ear, nose and throat (ENT) specialist with 45 years' experience of successful treatment of learning, audio-vocal and behavioural problems.

In the 150 centres around the world—where Professor Tomatis's 'listening cure', pioneered in his Paris clinic, is now available—teachers, musicians, psychologists and speech, music and occupational therapists are successfully applying the technique to a variety of learning and communication disorders. Tomatis's thesis, which is that all communication or learning disorders have their origins in impaired or under-developed listening skills, is gaining credibility among others working in the field of speech and hearing. Such disorders as illiteracy, stuttering, dyslexia, inability to learn languages, impaired concentration and memory, lack of verbal fluency or coherence, as well as more generalised problems including depression, fatigue and shyness are, according to Tomatis, linked to an impairment in auditory skills which causes us to become disconnected from our environment and so unable to communicate as well as we might with the outside world.

The crucial distinction between hearing (essentially a passive sensory process of absorbing sound) and listening (the voluntary focussing on specific sounds), is integral, says Tomatis, to the understanding of how and why 'natural' self-expression and communication often falter or break down altogether. Even non-vocal skills such as writing, which translates sounds into graphic form, may suffer if the sounds of language are poorly integrated. In extreme cases, withdrawal from normal life and communication may be chronic, as in the case of the actor Gérard Depardieu, who, until coming to Tomatis in his late teens, had been too inhibited to talk freely with other people.

The son of an opera singer, Tomatis has an innate musical ear. It was his early experi-

ence as an ENT specialist, working with hearing-impaired factory workers and, more significantly, with opera singers including Maria Callas, which first instilled the belief that chronic vocal problems may be caused not by structural deformities in the larynx but by listening to one's own voice—a mechanism he calls "self listening". This convinced him that one can reproduce vocally only what one's ear can hear. By analysing his patients' hearing he discovered that not only does each person possess a unique auditory curve—its peaks and troughs indicating which parts of the sound spectrum the ear registers more or less clearly—but that those frequencies we hear least or not at all always correspond to the range we cannot easily reproduce when speaking or singing. This discovery was formally recognised as the Tomatis Effect by the French Academy of Sciences in 1957.

Because of its direct neural connection with the left hemisphere—the side of the brain that governs logical thought-processes and activities including speech—the right ear normally is, or should be, the dominant or 'leading' ear: the 'musical' ear in the case of singers and musicians. The right ear therefore plays a crucial role in the vital feedback loop between speech or song and the act of listening. Any imbalance or interference with the function of the right ear causes the voice to become distorted and speech to lose its fluency.

By fine-tuning his electronic equipment, Tomatis was able to identify the crucial role of high-frequency sounds, from 4,000 cycles per second (Hz) upwards, in listening and speech. Lack of vocal fluency, musicality or tone becomes most noticeable when we are exposed primarily to low frequencies—for example, when the bass on a stereo system is turned right up—to which the left ear appears to be chiefly attuned. Such ill-effects become more pronounced when the higher frequencies, to which the right ear is most sensitive, are diminished or screened out altogether. Since the high-frequency band—typically between 2,000 and 4,000 Hz—covers the upper range of the human voice in most languages, giving it its timbre, the degree to which this is, or is not, picked up by the ear is obviously crucial to the ear-voice feedback theory.

The implications of his discovery for foreign-language students is intriguing, since it suggests that there is a sound scientific basis for the lack of a 'good ear' for languages which no amount of traditional learning can alter. According to Tomatis's findings, each nation possesses a collective ethnic 'ear', and inhabitants' spectrum of hearing is governed by a 'preferred frequency' which is also reflected in their speech. Thus the German 'ear', says Tomatis, hears between 100 and 3,000 Hz; the French between 1,000 and 2,000; the English between 2,000 and 12,000; the American between 750 and 3,000. The apparent ease with which the Slavs master foreign languages is due to their extraordinarily broad range of hearing, from 100 to 8,000 Hz. "Their aptitude is more for hearing than for speaking," he explains. The theory could explain why, for instance, the French experience difficulty in tuning into the English but not the American ear: the American band peaks at 1,500 Hz, not far removed from that of the French.

The success of his method as a linguistic aid comes from teaching students to modify their hearing, and so adapt their way of talking to correspond to the frequency range of their chosen language. The fastest, most effective way of doing this, says

Tomatis, is to make students listen to tapes made up of sounds, rhythms and frequencies specific to a given country. In order to become attuned to American speech sounds and rhythms prior to filming *Green Card*, Gérard Depardieu again consulted Tomatis, this time to undergo an American-style 'sonic rebirth'.

Although Tomatis's method is now increasingly applied by teachers and therapists to improve performance in language and vocal skills and to treat children's learning disabilities ranging from dyslexia and poor concentration and memory to disorders such as stuttering and even autism (which Tomatis interprets as the ultimate expression of a child's refusal to listen), many of its underlying theories remain controversial. Professionals struggle, for example, with his view of the ear as not merely an instrument for hearing and maintaining balance, but as a generator which uses sound's vibrational energy to charge the entire organism via bone, viscera and neural impulses—in particular, stimulating cortical energy and brain activity and so providing the motivation for speech, communication and learning.

Because the tiny sensory hairs in the inner ear are far more dense in the area which responds to high frequency than in that reserved for the low range, Tomatis claims there can be little mystery as to which sounds possess the greater energising properties—or why. "It is well known that the auditory apparatus acts as a charging or energising dynamo," Tomatis told me. "It furnishes

the current to feed the brain." He uses a combination of Mozart's music and Gregorian chants throughout all stages and applications of his method since he claims that their rich harmonic structure and predominant high-frequency range possess a unique generating power.

Could the ear also act as a regulator of other bodily functions, as Tomatis believes? Given that almost all cranial nerves lead to the ear, this is perhaps not as fanciful as it sounds. Tomatis is not the only person to make the connection between listen-

ing to music, chanting or singing, and feelings of improved wellbeing and greater energy. In England, sound therapist Jill Purce has long recognised and applied the healing benefits of sound and Tibetan overtone chanting to treat a host of physical and psychological ills. According to Tomatis, the most plausible rationale for these positive effects is that all the vital organs and processes are influenced by the ear through their tie-in with the tenth cranial nerve, which directly and indirectly, via branch lines, links the ear to every other organ in the body. Unusual as it may be, this perspective of the ear illustrates why so many 'bad listeners' not only have speech and learning difficulties but also, along with their flat, colourless voices, suffer more generalised symptoms of fatigue and depression, and faulty coordination, balance and posture. It also indicates why improvement in mood and energy levels is one of the most immediately noticeable effects of the training program—in which Tomatis's invention, the "electronic ear", superimposes 'perfect' hearing, allowing the patient to listen to music, speech or their own voice, but electronically doctored to emphasise the higher frequencies until their own ear is sufficiently conditioned to pick these up naturally.

But how and why do so many of us become bad listeners in the first place? According to Billie Thompson, Director of the Sound, Listening and Learning Center in Phoenix, Arizona, 'good' listening may be impaired at any age, through accident, emotional

Could the ear also act as a regulator of other bodily functions, as Tomatis believes? Given that almost all cranial nerves lead to the ear, this is perhaps not as fanciful as it sounds.

shock, illness, lifestyle changes, or trauma suffered before, at or after birth, thus weakening the mother-child audio-vocal link that forms the foundation for the child's later acquisition of language and communication skills. "The inability to hear the natural mother's voice may have a traumatic emotional impact on infants," she asserts, "whether due to a physiological difficulty caused by developmental delay, or because the mother is not there with the child due to some extended separation such as adoption, illness or even death." Such an experience may prevent the infant from responding to certain sounds, including speech, ever afterwards—something APP specialists identify as an instinctive protection mechanism against sounds that are too loud or associated with experience of trauma.

Physiologically, this protection mechanism manifests itself through gradual loss of elasticity of two tiny muscles, the *stapedius* and the *tensor tympani*, which are connected to the hammer and stirrup ossicles of the middle ear, and eventually the loss of tone necessary to perceive and differentiate between sound frequencies. The principal function of the electronic ear is to condition these muscles to respond to all frequencies more efficiently and to encourage dominant function of the right ear. As listening skills improve, students participate more actively—speaking, reciting, singing, chanting—while listening to the feedback of their own electronically 'improved' voices until they spontaneously and naturally reproduce those desired sounds. As listening improves, so do the quality, modulation, fluency and articulation of their speech.

Apart from its obvious advantages for singers, musicians, linguists, actors and anyone dependent on good communication skills, the method is particularly valuable in overcoming learning difficulties. The structure, content and length of programs

varies—average is 30 days of listening sessions spread over several months—but almost all commence with a recreation of the earliest stages of auditory and language development to overcome blocks caused by early trauma. This includes simulated sounds of the womb and a sonic 'birth', based on filtered recordings (if possible) of the mother's voice, the chief instigator of a child's desire to communicate with the outside world. Students then progress to listening to tapes incorporating rhymes, chants, folk songs, vocal exercises, and phonemes—the building blocks of language—played at progressively higher frequencies. Finally, the student reads or sings aloud under the electronic ear to reinforce his audio-vocal control.

Underscoring all of this is the Mozartian leitmotif, as an aid to receptivity, relaxation and motivation. Buy why Mozart? Decades of research show that despite their beauty, the works of other composers do not improve auditory skills, concentration and alertness.

On the contrary, Chopin tends to encourage day-dreaming and absent-mindedness linked to learning disabilities; Beethoven can deepen feelings of depression and melancholic withdrawal; while Paganini, Wagner or military marches may over-arouse children to irritability, aggression and hyperactivity. Most destructive, warns Tomatis, echoing other sound researchers, are the new 'sonic drugs'—loud rock music, personal stereos—which hypnotise and heighten bodily sensation by low-pitch stimulus while destroying the ear and its functions, isolating us from our environment and shattering any desire to communicate. When tempted to shut out the world in this way, we would do well to remember the possible cost of escape.

(This article, written by Alix Kirsta, was originally published in VOGUE, Paris, June 1992 edition.)

**There are about 250 Tomatis Centres in the world.
For further information, we suggest you contact
one of these addresses near you, or visit the
Tomatis Web Page at: <http://www.tomatis.com>**

**The Tomatis Centre (UK)
3 Wallands Crescent
Lewes, East Sussex BN7 2QT, UK
Ph +44 (0)1273 478666
Fax +44 (0)1273 487500**

**Tomatis International (France)
6 Place de la République Dominicaine
75017 Paris, France
Ph +33 1 43 80 92 92; Fax +33 1 42 27 93 91**

**Lafayette Tomatis Center (USA)
3700 Mount Diablo Boulevard, Suite 300
Lafayette, CA 94549, USA
Ph +1 510 284 8431; Fax +1 510 283 0961
E-mail: tomatis@ix.netcom.com**

**Kay Distel / Sound Education (Australia)
3 Coutts Place, Melba, ACT 2615, Australia
Ph (06) 259 1364; Fax (06) 258 5530**

**SOUND AS A MODULATOR OF CONSCIOUSNESS
by Tom Kenyon, M.A.
Director of Research and Development
Acoustic Brain Research**

The Vedic Rishis of ancient India coined a term that conveys their experience of the world as vibratory in nature. The term *nada brahmin* means literally "the world is sound". And modern quantum physics would agree with this basic tenet.

The science of *mantra*, which has evolved over thousands of years, directly seeks to affect consciousness itself and, in some cases, matter, through the use of specific vibratory keys. These vibratory keys or *bijas* (seed sounds) can profoundly affect awareness.

In my own work with groups and individuals I have found that the use of mantras or chants can seemingly transport one to other dimensions of consciousness. I have also found that these vibratory keys work even if they are not inherent in the culture of the participants. I use, for instance, mantras and chants from numerous traditions including Buddhist, Christian, Hebrew, Hindu, Moslem as well as from indigenous cultures. All of these have the ability to affect people profoundly.

Empirical research from a number of sources has clearly documented that mantras or chants have a direct effect upon brain processing and physiology. Certain classes of meditative mantras have been shown to have very positive physical as well as mental/emotional benefits.

Some of these benefits include: a reduction in stress hormones such as adrenaline; the lowering of respiration and heart rate; slower EEG activity (with increases in alpha and theta activity); and, in some cases, a slowing of the ageing process.

Research by Dr Herbert Benson (Harvard) has demonstrated

that almost any 'neutral' word repeated silently to oneself generates some of the benefits documented with meditative mantras. It may actually be the repetitive nature of mantras that is partially responsible for slowing down EEG in the first place. Repetitive sensory patterns affect the reticular activating system (RAS)—a network of nerve fibres in the brain that searches for novel stimuli. When a sensory pattern is repeated long enough, the RAS slows down neocortical activity and, when a new sensory pattern is introduced, the RAS stimulates the neocortex into heightened activity.

However, meditative mantras may have more subtle effects on human physiology than those created by the repetition of sound. New technologies for monitoring the actual energy fields of the body hold promise in this area. I personally suspect that the vibratory nature of certain languages, such as Sanskrit (the language of ancient India), will be documented to have numerous subtle effects—as distinct from Benson's 'neutral' words.

For the last decade or so I have focused on the use of sound to produce altered states of consciousness. It is in these states, characterised by heightened alpha and theta activity, that we have access to the more creative aspects of awareness. With the normal day-to-day sensors suspended, non-ordinary experiences can occur. Such experiences often have physically-healing, emotionally-transformative and even spiritual effects.

In much of my previous work I focused on the use of electronically-generated tonal patterns (as with tone generators) to affect both brain processing and awareness. Laboratory studies clearly showed that this method of working measurably affected the brain state. In other words, we could create a window of brain activity by directing specific pulsating sounds to the auditory system of the brain. If, for instance, I pulsed a 7-Hz signal to a subject, his or her brain activity would tend to move towards mid-theta.

Subsequent research has shown that 'entrainment' moves a subject's brainwave activity towards the same hertz (Hz, the number of cycles per second) as the entrainment frequency, but there is not necessarily an exact match.

It was in the course of this technical work that I stumbled upon a study that showed that shamanic drumming produced strong theta activity in the brain. This intrigued me, and I began to explore indigenous methods and instruments for altering consciousness.

I have found the use of shamanic sound to be a most interesting and complex system whereby consciousness itself can be directly affected. While shamanic drumming is an effective tool to alter brainwave patterns, I have found that this is greatly enhanced by using the human voice. Noted researcher Barbara Hero (MIT) has stated that the two purest forms of sound come from a pure tone generator and the human voice.

What I have found most intriguing is the ability of modulated sound, as in overtone chanting, to affect a subject's physiological processes while he or she is in an altered state of consciousness (trance).

I had a dramatic experience in this regard while teaching a class in Atlanta, Georgia, a few years ago. There was a woman who had been suffering from a compound fracture of the femur for several months. She reported that she was in constant pain and

could not put pressure on her leg. During the course of the training, I instructed almost 50 people in how to use sound for physical healing, and this woman received healing sounds from the group. Excited, she called me the next morning to report that she was without pain for the first time in months, that she could put weight upon her leg and that she was now walking without her cast!

It has been documented by some trained observers that mantras or chants can affect external events, especially weather. Tibetan yogis have been noted to produce hailstorms and fair or inclement weather just by using specific mantras. In America, some indigenous tribes have been observed to affect rain through communal dancing and chanting, even into this century.

The ethnobiologist and researcher Terence McKenna has reported how sound can seemingly alter DNA activity during trance states produced by plant hallucinogens. I personally have no doubt that this is possible, though I don't think that hallucinogenic substances are a requirement. What is required is that consciousness be more fluid in the individual.

Our day-to-day patterns of perception and action tend to be rigid and, with that, individual consciousness becomes limited. Methods for freeing up our attention or perception exist that do not rely upon hallucinogens, and this has become a research interest for me.

It is a natural next step to study the effects of shamanic sound in the laboratory, and this is what I am presently undertaking. It is an observable fact, based on hard data and clinical observation, that shamanic sound can profoundly alter brainwave activity and awareness. What

is most compelling for me is the possible scientific documentation of shamanic sound and its effects on actual physical- and micro-processes (such as genetic and neurotransmitter alterations). Here, the essential question is, "Can the purported changes in physical and neurological structure, as a result of shamanic sound, be measured—or are these changes more in the order of a mythology?" I think this question will become answerable from a scientific measurement perspective over the next 10 years.

Even as I continue to conduct and co-ordinate research into the effects of shamanic sound, I often use it clinically or in group training sessions for I have found it unsurpassed as a doorway to altered states and other dimensions of consciousness. I often witness profound emotional and physical healings occurring when people enter these non-ordinary dimensions of awareness. Touching the depth of one's nature through sound seems to have a universally transformative effect. As a researcher I continue to be intrigued by the neurological effects of sound, and as a practitioner I am continually awed by the power of sound to touch, to inspire and to heal.

About the Author:

Tom Kenyon, M.A., set up Acoustic Brain Research in 1983 in order to document scientifically the effects of sound and music on the human nervous system. He is also the author of *Brain States* (US Publishing), a critically acclaimed practical guide to the brain and its unused potentials.

Tom Kenyon can be contacted at:

Acoustic Brain Research
640 Oceanview Drive
Friday Harbor, WA 98250, USA.

It has been documented by some trained observers that mantras or chants can affect external events, especially weather.

UNKNOWN ALLOYS REVEALED IN ANCIENT PALM LEAF MANUSCRIPTS

by Robert Goodman ©1996

Until the printing press came into use throughout the world, each culture had its own way of conserving the knowledge passed on from one generation to another. In India, the most common method was to write on palm leaves. This method was used for communicating diverse subjects pertaining to all the different branches of wisdom.

In recent years, a highly qualified minority of Hindu researchers has been dedicated

to finding, gathering and translating ancient texts. One of these researchers, the writer and Sanskrit scholar Subramanyam Iyer, has spent many years of his life deciphering old collections of palm leaves found in the villages of his native Karnataka in southern India. Several years ago, he discovered some old texts which described different alloys (with properties unknown to modern science) and their application in the building of fuselages of Vedic *vimana* aircraft.

Thinking about the possible application of these formulas in the modern aeronautics industry, S. Iyer wrote to C.S.R. Prabhu, the Technical Director of National Informatics Centre, the Indian Government

department dedicated to translating ancient texts and searching for applications of the technologies recorded in them. In his reply in May 1991, Prabhu informed Iyer that he had started a study of several Shastras (Vedic science texts) recorded on palm leaves and had already managed to prepare some of the materials described. They were metal alloys with very promising properties applicable to modern science and technology.

Hence, already by 1991, samples of these alloys were being tested and exhibited, and access to them was authorised for anybody interested in them. According to the initial results, it seemed that most of the materials were unknown, but, given their unique properties, they could have applications in aeronautics, aerospace

technology and defence.

In September 1992, a national Indian newspaper published an article confirming that ancient texts written in Sanskrit had been found the year before in a village in Karnataka, and that, on translation, they were discovered to be a complete compendium of formulas for manufacturing super-alloys, with properties unknown in modern times.

The article quoted C.S.R. Prabhu, of the National Informatics Centre, who stated that he had prepared five different alloys described in the texts and was currently working on others. Each alloy had unique characteristics, with definite applications in modern metallurgy. According to Prabhu, more was needed than a mere translation in order to understand the texts: they had to be deciphered.

Part of the language used pre-dated classical Sanskrit, but, as many of these words were to be found in Ayurvedic texts, it was possible to complete the interpretation. Prabhu assured that, up until then, texts of this class had not been found in any part of India, and, in fact, the information they contained came from a rich oral tradition, possibly extending over thousands of years, before being recorded on palm leaves.

Impossible Alloys

The article went on to say that at a recent congress in India, C.S.R. Prabhu gave a paper on these alloys, claiming that samples prepared according to the formulas described have the same properties as those stated, and that they were being tested not only in India but also abroad. For example, the University of San Jose (California) was performing tests with several products.

Among these materials, *tamogarbha loha*, a lead alloy, absorbed up to 85 per cent of the light generated by a ruby laser. *Pancha loha*, an alloy of copper with lead and zinc, showed great malleability and an enormous corrosion resistance to salt water—a property not observed until now with any alloy containing copper, but having an obvious use in the construction of ships' hulls.

Araara tamra, another anticorrosive alloy, was brittle and very light. *Chapala*

RUKMA VIMANA

— PROFILE —

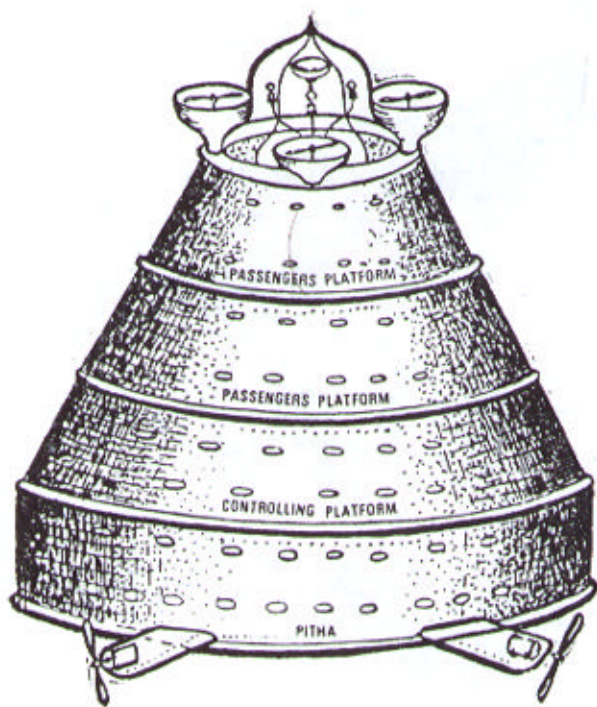

A 1923 drawing of a *vimana*, by T. K. Ellappa of Bangalore, India, prepared under instruction from Pandit Subbaraya Sastry of Anckal, Bangalore. Note that propellers were not mentioned in the original texts: they were placed there by scholars who assumed they should be somewhere. (Source: *Vimana Aircraft of Ancient India & Atlantis*, 1991)

grahaka was found to be a high-quality ceramic material which, with slight modifications, produced a very soft, acid- and base-resistant glass.

So far, according to the article, processes had been deciphered to make another 14 products, two of which seemed to be very promising: *bhandhira loha*, a soundproof alloy, and *vidyut darpana*, a glass capable of neutralising lighting.

C.S.R. Prabhu mentioned that the texts also describe the sections of mines in different places and the kinds of minerals that could be found at distinct levels, as well as extraction and purification methods.

Apparently, some of these texts were written by Maharshi Bharadwaja, and indicate that knowledge regarding high technology was indeed possessed by the ancient sages of India but was lost over the ages.

When I received a copy of this 1992 article, I immediately wrote to C.S.R. Prabhu, asking him to confirm its contents.

His reply was adamant, and he informed me that at present he was trying to prepare a glass capable of absorbing solar heat, and an alloy used in the fuselages of *vimana* aircraft for absorbing the excess heat produced by air friction at high speeds.

According to Prabhu, he and some of his colleagues intend creating a research institute to manufacture the different alloys mentioned in the *Vymanika Sastra*.

They also plan to decipher the palm leaf manuscripts relating to another Shastra, the *Amsu Bodhini*, which, according to an anonymous text of 1931, contains information about the planets; the different kinds of light, heat, colour, and electromagnetic fields; the methods used to construct machines capable of attracting solar rays and, in turn, of analysing and separating their energy components; the possibility of conversing with people in remote places and sending messages by cable; and the manufacture of machines to transport people to other planets.

All this seems to confirm that the discoveries of modern technology have already been achieved.

Somewhere, some place, such knowledge has been recorded. It is up to us to find it—instead of claiming that no other civilisation has ever reached our level of superiority.

(This article was first published in Mas Alla de la Ciencia [Monograph no. 17, June 1996], the Spanish journal dedicated to ancient technologies.)

SUPPRESSED ENERGY DEVICES by Byron S. Wine III

I want to relate to you some facts concerning various suppressed energy devices and the difficulty in bringing this information to the public.

Shell Oil's Predictions

Some folks at Shell Oil Co. wrote *Fuel Economy of the Gasoline Engine* (ISBN 0-470-99132-1); it was published by John Wiley & Sons, New York, in 1977.

1) On page 42, Shell Oil quotes the president of General Motors who, in 1929, predicted 80 miles per gallon (mpg) by 1939.

2) Between pages 221 and 223, Shell writes of its achievements: 49.73 mpg around 1939; 149.95 mpg with a 1947 Studebaker in 1949; 244.35 mpg with a 1959 Fiat 600 in 1968; 376.59 mpg with a 1959 Opel in 1973.

The Pogue Carburettor

In the book, *Secrets of the 200-mpg Carburetor*, by Allan Wallace (from Premier Distributing, 1775 Broadway, NY, NY, 10019, USA), page 18 has photocopies of three 1936 tests by the Ford Motor Co. (Canada) of the Pogue carburetor (US Patent #2,026,798). The worst-case test achieved about 171 mpg (US).

Tom Ogle and the "Oglemobile"

Argosy magazine, August 1977, published a five-page article about Tom Ogle and the media-witnessed test of the

"Oglemobile". On that test run, Tom Ogle achieved more than 100 mpg in a 4,600-pound 1970 Ford Galaxie.

The Ogle US Patent #4,177,779 contains this statement: "I have been able to obtain extremely high gas mileages with the system of the present invention installed on a V-8 engine of a conventional 1971 American-made automobile. In fact, mileage rates in excess of one hundred miles per gallon have been achieved with the present invention."

According to the *Argosy* article, a Shell Oil Co. representative asked Ogle what he would do if someone offered him \$25 million for the system. Ogle responded, "I would not be interested." He later said, "I've always wanted to be rich, and I suspect I will be when this system gets into distribution. But I'm not going to have my system bought up and put on the shelf. I'm going to see this thing through—that I promise."

According to an article in the *Washington Post Parade* magazine (4 March 1984), Tom Ogle died of a drug-and-alcohol overdose in 1981.

Other articles concerning Tom Ogle can be found in the *El Paso Journal* (16 January 1980) and also the *Hamilton Spectator* (24 June 1978).

The Oglemobile, in simplification, ran on fumes extracted from a heated tank in the trunk (see the Ogle's patent). A very simple method of extracting gasoline fumes is described in the book, *Gas Engine Construction*. Originally published in

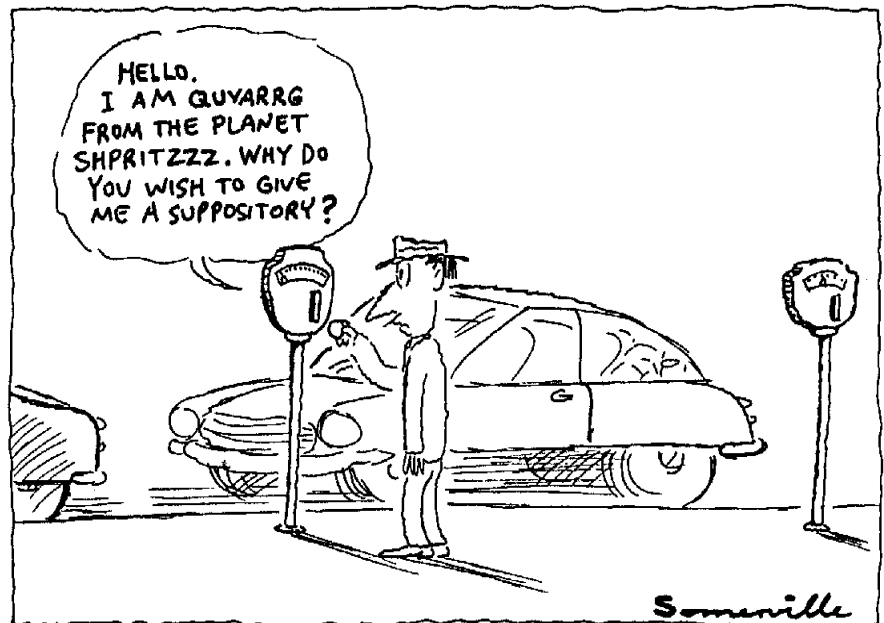

NEWSCIENCE NEWSCIENCE NEWSCIENCE

1900, this book was reprinted by Lindsay in 1986 (ISBN 0-917914-46-5).

Patents for Vaporising Gasoline

Many US patents have been granted for vaporising gasoline: NASA Patent #3,640,256; General Electric Co. Patent #3,926,150; Robinson Patent #4,003,969; Harpman Patent #4,023,538; Butler Patent #4,068,636; Totten Patent #4,106,457.

Don Novak

During the mid-1970s, physicist Don Novak travelled all over the US lecturing and teaching in his seminars how to achieve 100 mpg. He also testified, on 15 October 1979, before a Wichita, Kansas, Congressional Committee on "Reinventing the Automobile". [Comment: I have known Don for many years. Once, in the late '70s, he brought to my home two carburetors: one got more than 200 mpg and the other more than 100 mpg. I contacted a local politician who lives in my town and was on the Virginia Energy Subcommittee. I tried to have this politician meet Don and see the carburetors. The politician was not interested.]

Diesel Miles Per Gallon

In the London *Daily Telegraph* of 20 October 1983, on page 9 there is an advertisement for a production Peugeot Diesel that achieves 52.3 mpg in urban driving. In the *Washington Post* of 19 September 1983, on page 37 is the 1983 US EPA fuel economy list of various vehicles. The US model Peugeot Diesel gets between 22 and 27 mpg. The *Washington Times* of 9 August 1991 published an article, "Gas-saving engines hit streets in fall". This article is about two engines, the Mitsubishi MVV, and the Honda VTEC-E. According to the company spokesmen, the Mitsubishi will get up to 50 mpg; the Honda, up to 88 mpg.

US Government Fuel Study

The US Government supported a study (Grant No. DTNH22-91-Z-06014) of automobile fuel economy by the National Academy of Sciences. This study, *Automotive Fuel Economy: How Far*

Should We Go? (ISBN 0-309-04530-4), was used by the staff of Congressman George Allen to refute documentation proving that an automobile had exceeded 376 mpg. Nowhere in this 'fuel economy study' is there any reference to the work of Shell Oil Co. or any other reference that could refute the conclusion of this report. The report, published in April 1992, concluded that a sub-compact car might achieve between 39 and 44 mpg by model year 2006.

Government Aims for 80 Miles Per Gallon by 2002

An article titled "Automakers Move Toward New Generation of Greener Vehicles" was published in *Chemical & Engineering News* on 1 August 1994. This article is about "The Partnership for a New Generation of Vehicles"—a partnership between the US Government and the auto industry that has a goal of an 80-mpg automobile by 2002.

Has 200 Miles Per Gallon Already Been Achieved?

On the subject of hybrid Diesel/electric automobiles (a Diesel/electric locomotive uses the same principle), the *Manassas Journal Messenger* of 4 April 1981 has an article about an MG sports car converted by San Diego State University. The car gets 110 mpg. The Steven R. Reed Automobile Manufacturing Corp. of Newport Beach, California, issued a press release, dated 14 February 1983, announcing the 23 February 1983 showing of the 200-mpg, two-passenger, II Millennium Cruiser at the Ambassador Hotel. The press release also states that the company will file "...a major class-action lawsuit involving a considerable number of giant American corporations within the automotive and petroleum industries, plus numerous branches and agencies of the US Government responsible for regulating these companies."

Vincent Carman

Mother Earth News, November/December 1977, has an article, "Can This Transmission Really Double Your Car's Mileage?". This article is about a Ford Granada modified by Vincent Carman of Portland, Oregon. In simplification, Mr Carman removed the transmission and drive shaft from the car and bolted an hydraulic motor to the differential. He then bolted an hydraulic pump to the engine to pressurise a storage tank. The storage tank is also pressurised when the car brakes or slows down. The article states that the US Post Office is interested in a whole fleet of vehicles using this principle. In 1990, after reading an article in *Federal Times*, I contacted Mr Robert St Francis, US Postal Service, who was searching for alternative fuels for use by the Post Office. Mr St Francis said that he had never heard of Mr Carman. I wrote two letters, 18 and 21 October 1990, to Mr St Francis concerning Mr Carman's vehicle, but I received no response.

Another article in *Mother Earth News*, March/April 1976 (or '78?), titled "This Car Travels 75 Miles on a Single Gallon of Gas", is about a project by the Minneapolis, Minnesota's Hennepin Vocational Technical Center that converted a Volkswagen to a system similar to that of Mr Carman. The idea for the conversion came from a 1920 magazine article. The car, with a Bradley GT body and a 16-horsepower Tecumseh engine (the original VW engine was too powerful), achieved more than 75 mpg at 70 mph.

More Suppression?

The *St Paul Pioneer News*, 22 August 1990, has an article about a group that 11 years previously modified a Dodge half-ton pickup furnished by a local dealer. This modified truck got more than 35

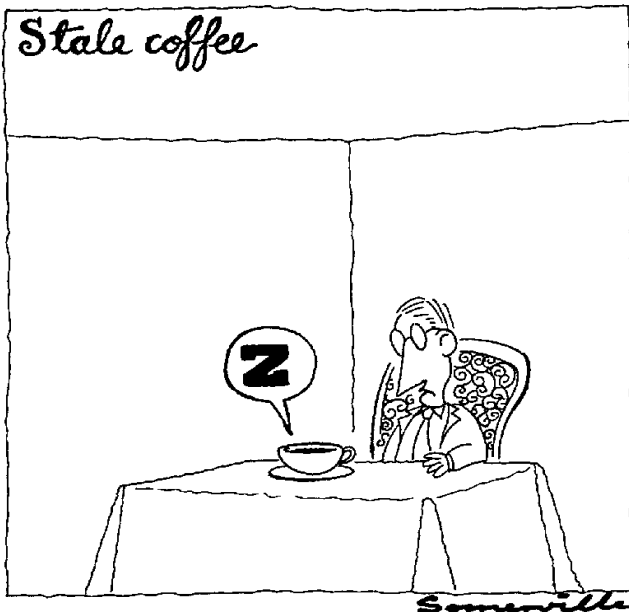

NEWSCIENCE NEWSCIENCE NEWSCIENCE

mpg. Tests on this modification were stopped when a member of the group was told that he would receive a pair of cement boots if testing continued.

Hydrogen Fuel

There are many US and foreign patents for extracting hydrogen and oxygen gases from water for use as a fuel. Some of these patents are: 2 July 1935, Garrett, #2,006,675; 3 April 1945, Klein, #2,373,032; 25 February 1975, Chambrin, French Patent Request #7506619; 6 July 1976 (owner unknown by me), #3,967,589 (this is a patent for an electrical power generator that burns water); 1976, Horvath, #3,980,053 (This statement is on the Horvath patent: "This invention relates to internal combustion engines. More particularly it is concerned with a fuel supply apparatus by means of which an internal combustion engine can be run on a fuel comprised of hydrogen and oxygen gases generated on demand by electrolysis of water"); 28 June 1983, Meyer, #4,398,981 (Mr Meyer has at least eight other patents relating to hydrogen and oxygen gases extracted from water for fuel).

Popular Science, in about 1978-79, published an article, "Hydrogen bus could also heat its own garage". This article is about the work of Dr Helmut Buchner of Mercedes-Benz. He is quoted as saying: "We are ready now. We could save our city of Stuttgart over one million gallons of petroleum fuel a year by converting its fleet of 300 urban buses to run on hydrogen. Heating—and air conditioning—would be free spin-offs, consuming no extra energy."

Popular Science, in March 1978(?), published an article, "Hydrogen demonstrates fuel of the future", about the work of Dr Billings of Billings Energy Corp., Provo, Utah, and others. The article states that at home, all the appliances and vehicles can be run on hydrogen. Dr Billings converted a Cadillac Seville for dual fuel use. This Cadillac, burning hydrogen, was in President Carter's inaugural parade.

Sealed Reciprocating Engines

I visited the Patent Office years ago, when they still had the open

stacks of 'shoe boxes'. While there, I read the application files for the Papp patent, #3,6(?)704,944. Papp applied for a patent on his engine, and the Patent Office, after consultation with the old Atomic Energy Commission, refused to give him a patent because his device could not possibly work. Papp came back with test results, photographs and depositions from, I think, 16 people. Papp said that maybe the Patent Office didn't know how his device worked, but that they also didn't know how the atomic bomb worked and used it anyway. This statement is on his patent:

"2. To provide a two-cycle reciprocating engine which does not use fuel-intake valves or exhaust valves, does not require an air supply and does not emit gases.

"3. To provide a precharged engine of the character stated in item 2 capable of generating power for a period of from 2,000 to over 10,000 hours continuously or until mechanical breakdown without the addition of fuel injection of air or discharge of gases..."

Britt, 31 August 1976, has a patent, #3,977,191, for a similar sealed engine. In the patent application file, Britt accuses the Patent Office of deliberately delaying his application to give a major manufacturer time to file on top of him.

Permanent Magnet Motors

Howard Johnson was granted US Patent #4,151,431 for a motor that is powered only by permanent magnets. An interesting thing about the first page of this patent is that it contains the chart for a magnetic field VS electromechanical coupling. The chart is from US Patent #4,151,432, which has nothing to do with the Johnson patent.

Science and Mechanics, Spring 1980, published an article, "Amazing Magnet-

Powered Motor", about the Johnson patent. The article tells of his difficulties in having the device patented. The patent problem was solved when Johnson took working models of his device to the Patent Office.

Joseph Newman's Energy Machine

I've spoken with Joe Newman many times over several years. He has recently published the seventh edition of *The Energy Machine of Joseph Newman* (ISBN 0-9613855-7-7). (Available from Joseph Westly Newman, Route 1, Box 52, Lucedale, Mississippi, 39452, USA; phone (601) 947 7174.) Joe filed suit against the US Patent Office because it would not grant him a patent. According to Joe's book (pages 274-279), the Court appointed a Special Master, Mr William E. Schuyler, a former Commissioner of the US Patent Office, to advise the Court. His finding was that Mr Newman had invented a machine that had more output than input. The Court refused to accept the finding.

An End to Suppression?

I hope that this information will raise questions as to why we are so dependant on foreign oil. All our government has to do, to take more money from our pockets, is to create an energy crisis or raise the cost of energy. The only financial interest that I have in any of above devices is that of a concerned consumer who is tired of the deliberate lies and cover-ups.

Byron S. Wine III

PO Box 1956

Manassas, VA 22110-0806, USA

Phone: +1 (703) 791 5893

Fax: +1 (703) 791 8420

E-mail: Byron_Wine@csgi.com

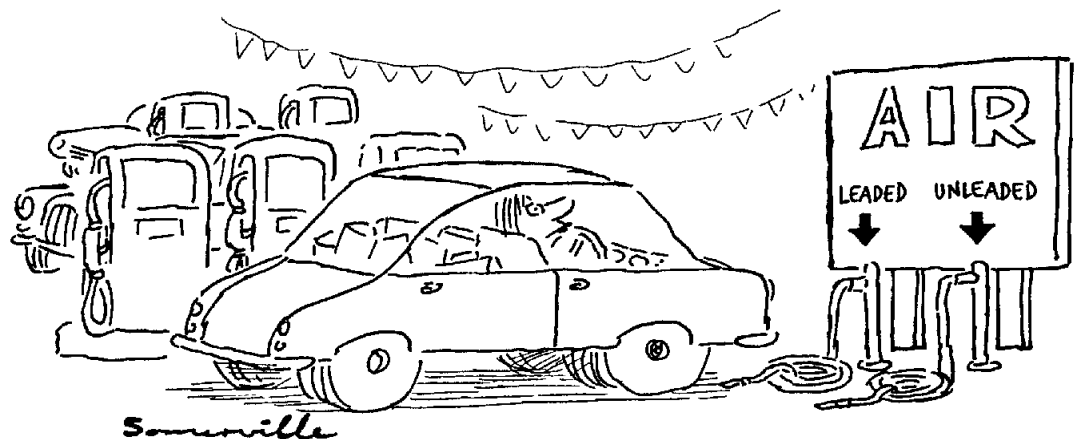

The *Poltergeist* Machine

Poltergeist effects may be as much the result of electromagnetic anomalies as the workings of mischievous discarnate spirits, as inventor John Hutchison has been able to demonstrate in his laboratory.

by Albert Budden, B.Ed.

©1996

17 Brook Road South
Brentford, Middlesex TW8 ONN
United Kingdom
Telephone +44 0181 560 9497

I have always been impressed by the Statement of Purpose published in each and every issue of NEXUS, to make available 'hidden knowledge', otherwise known as 'gnosis', in order to assist people cope with the changes that the planet is going through. Whilst the paranormal may not have the serious consequences for people as war or environmental concerns, it would be difficult to state with any confidence that psychic phenomena and the UFO issue have not engaged public attention on a grand scale. The reasons for this boom are obscure, except that it could be said that people are looking for something that makes their lives meaningful.

As for myself, I have been an investigator of anomalies for almost 16 years and have certainly found a rich source of fascinating material—and, recently, an inventor who has helped me make sense of one of the prime mysteries of our time: poltergeists.

It is the amazing discoveries of this man, one John Hutchison, from British Columbia, Canada, that I would like to share with you here.

POLTERGEIST ACTIVITY

The general public has been treated to big-budget, special-effects movies on poltergeist activity and has been led to regard it as consisting of spectacular phenomena involving spirits from other dimensions who enter our domestic world and wreak havoc. I suspect that few film-goers realise that there is a reality behind this movie mythology, where furniture does move, objects do levitate and sail round the room, fires do start behind locked doors and in impossibly enclosed places, water does mysteriously vanish, objects do appear to arrive from nowhere and seem to vanish just as strangely, iron bars are found twisted and broken, and mirrors shattered.

Probably most bemusing, however, are the effects on electronic devices and electrical equipment, causing them to perform strange feats. Television sets switch themselves on and off, repeated telephone connections are made which engineers consider 'impossible', and computers show programmes that have not been installed by anyone or information that is inaccessible through normal use. What causes these weird and unnerving effects, and what do they have to do with an inventor in Canada?

AN INVESTIGATION

Cases come my way through contact with people who know of my interest in anomalies (I have had three books published), and each case brings its own surprises. I was certainly not ready for the situation I met when I arrived at the 'haunted' home of a middle-aged couple in Welyn Garden City in Hertfordshire, UK. I use a small tape recorder for interviews, and as we settled down in their comfortable lounge I was startled by the noise of a loud crack which seemed to come from the wall opposite me. Neither Jane nor David, as I shall call them, reacted with any degree of surprise. "That happens all the time," they told me casually. Somewhat distracted, I fiddled with my tape recorder, setting it down on the low table before me, beside a cup of coffee. Apparently, unexplained noises were commonplace in this household, including some heavy, plodding footsteps along an upper passage during the small hours of the morning.

Jane and David then regaled me with accounts of light bulbs which constantly popped, a video recorder which refused to work on some days, vases of flowers that sailed into the air before dashing themselves on the carpet, matches which caught fire spontaneously inside their box inside a drawer, water taps which turned themselves on and off, the doorbell which chimed as they stood at the open door with nobody pressing the button, dressing-table mirrors which cracked increasingly almost every night, a stone statue on the

patio which caught fire and explosively lost its arms, legs and head (all of which were found several yards away down the garden), and most disturbing, considering the amounts of energy involved, a large heavy hardwood table which overturned itself overnight on a regular basis (about twice a week).

Barely taking all this in, but knowing that I had it all on tape, I reached for the coffee in front of me on the table—but it was swirling around in the cup like a mini-whirlpool. I looked at Jane and David who just shrugged in unison. The whirlpool effect stopped suddenly, but I had lost interest in drinking my coffee.

Readers in the UK, USA and Australia who have read my books may realise that I am no longer puzzled as to the causes of such phenomena, as I feel sure, after 16 years, that I know what they are.

One of the instruments that I always take on any investigation is a field meter which measures the levels of electromagnetic pollution at a location. Jane and David allowed me to wander around their home with the meter, and it soon became clear to me as I went from room to room that the place was subject to sudden and powerful power surges. I could have foreseen this, even if I had not developed the electromagnetic pollution approach (for which I am known) for the understanding of anomalies, as there was a 40-foot-tall radio mast, for transmitting line-of-sight microwave signals, erected just five feet away from the outside wall. Apparently, as the planning and safety authorities do not regard siting power lines over residential properties as hazardous to health, a microwave tower is thought of as nothing to be concerned about.

Jane and David's health problems were typical of people who have spent a prolonged period close to a source of electromagnetic fields. Their problems included masked food allergies, chemical sensitivities, electrical hypersensitivity, and photophobia (hypersensitivity to light) which forced both of them to wear tinted spectacles. Their condition was not helped by their having been radio hams for several years; this only added to their exposure levels.

The readings in several rooms exceeded 100 milligauss per metre as a magnetic field density; between 25 to 35 kilovolts electric field; and over 0.5 milliwatts per square centimetre intermittently in the RF scale. None of the fields was constant, but they would suddenly surge through the house.

Even before I had taken any readings, I was aware of the typical signs and symptoms that I feel when exposed to a strong field source. I felt a tingling sensation on the backs of my hands, the hairs on my arms stood out, and throughout my visit I battled with a thunderous headache which came on seconds after entering the house and lifted 10 minutes or so after leaving it. I have not found one case of 'poltergeist' activity which did not happen in an electromagnetic hot-spot.

It was a deep-in-thought investigator who took the train home to London, and I could not resist listening to the recording I had made. However, not really to my surprise, the tape was blank. Instead, I thought of the implications of these weird field effects

and realised that to anyone with a layman's knowledge of electromagnetic fields they must appear as an extremely unlikely energy source to produce the movement of objects and materials that did not have ferrous content (i.e., ceramics, water, stone, concrete and wood). Anyone who has experimented with magnets soon finds out that only iron is affected. It was little wonder that psychokinesis or PK was thought to be involved, but I regarded this as a distinctly different process from apparent poltergeist activity.

ANALYSIS OF 'POLTERGEIST' PHENOMENA

From a scientific point of view, how could all of the strange effects reported by Jane and David be understood? Let us take them one at a time:

1. Light bulbs constantly 'pop'.

A power surge will supply power to a circuit through the atmosphere and through the glass of a bulb, subjecting the tungsten filament to increased levels of electricity. These repeated 'boosts' to a filament will create a small movement each time, especially when the filament is hot and more flexible when the bulb is on. It will not be long before this repeated movement induces metal fatigue, and soon, when the light is switched on, the filament will break with that familiar 'ping'.

2. The video machine malfunctions on some occasions but works on others.

A magnetic field can affect the electronic circuitry, causing it to malfunction by inducing what are known as magnetostrictive effects. That is to say, a magnetic field will cause the microscopic ferrite components to deform so that critical contacts are lost—in turn, inducing the circuitry to

fail. When the field drops, the ferrite components resume their normal dimensions, contacts are regained and the circuitry functions normally.

3. Loud snapping 'clicks' and heavy, plodding footsteps are heard.

When iron or steel is magnetised by a field which then abruptly drops, an auditory sound wave is produced by a mechanism called magnetostrictive acoustics, also known as the Page Effect. Deep-sounding 'thuds' or high-pitched 'cracks' will be heard depending on the thickness and length of the metal and how it is held in place in a building. For example, thick metal girders embedded along a floor will produce a series of progressive 'thuds' as the field moves along them, giving the impression of footsteps, whereas a thin iron conduit carrying wiring embedded in a wall will produce a sharp 'snap'.

So far, these phenomena can be understood by identifying them in the *Handbook of Magnetic Phenomena* by Harry E. Burke.¹ The fires inside matchboxes which are inside drawers could certainly be ignited by the thermal effects of microwaves, and I have personally seen flash-bulbs blown at a distance by the diathermy

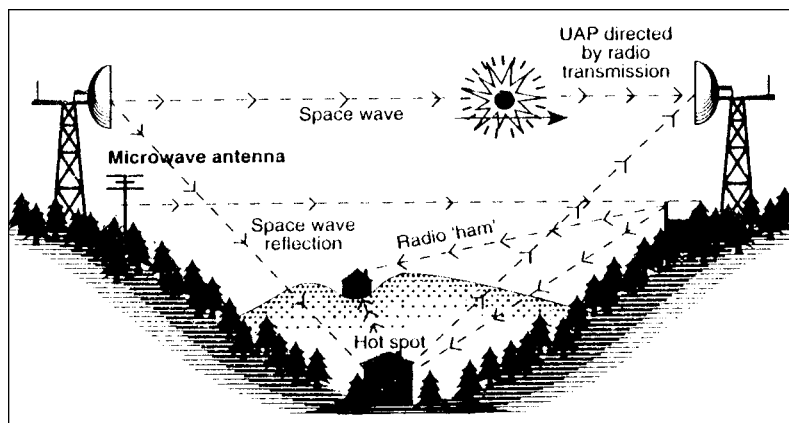

Diagram showing typical electromagnetic pollution scenario which produces hot spots in which the "lift and disruption" phenomena of the Hutchison Effect can be generated.
(Source: *UFOs: Psychic Close Encounters - The Electromagnetic Indictment*, Blandford, 1995)

effect induced by a microwave field. The chiming doorbells could easily be induced by power surges activating the circuitry, just as car alarms can be set off in this way. One would not have thought that taps could be turned by magnetic fields because of the levels of mechanical force needed, but it was pointed out to me that a whole range of seemingly mysterious events, including doors locking, windows flying open and taps turning, can be typical indicators of imminent Earth tremors. Such reports are collected by seismologists and are known as "diagnostics". These revelations have shown me that not everything can be understood from a commonsense, everyday logic point of view and that 'hidden knowledge' can be found through a disciplined tradition of repeated mental exercises, commonly known as education!

However, as we work our way down the list of 'poltergeist' phenomena, it becomes clear that there is a point where the laws of physics cannot help us and we venture into the realms of the unknown, the unclassified and the purely experimental. How do objects, some of them quite heavy, levitate when they are not made of iron or have any iron content? (The heavy table must have moved for it to have overturned.) How does stone and/or concrete shatter and/or catch fire? How does mirror-glass crack? And how did electromagnetic fields make my coffee turn into a mini-whirlpool before my eyes? I had a problem. I knew that poltergeist activity took place in electromagnetic hot-spots, but what were the physical mechanisms involved in generating these effects?

THE POLTERGEIST MACHINE

This is where the experimental findings of John Hutchison, the electromagnetics pioneer in British Columbia, Canada, enter our arena of understanding—up to a point, that is. For what he has fortuitously discovered shows without a doubt that poltergeist activity is electromagnetic in nature. His research opens doors which lead to more questions than answers.

So what is it that Hutchison found that made the national television news in three different countries (the USA, Japan and Canada)?

Basically, what Hutchison did was cram into a single room a variety of devices which emit electromagnetic fields (such as Tesla coils, van de Graaff generators, RF transmitters, signal generators, etc.). He found that after they had been running for a while, effects began to occur that were identical to what have come to be regarded as poltergeist phenomena. Objects of any material levitated into the air and hovered there, or moved about and then fell; fires started in unlikely places around the building; a mirror smashed at a distance of 80 feet away; metal distorted and broke; water spontaneously swirled in containers; lights appeared in the air and then vanished; metal became white-hot but did not burn any surrounding materials; and so on.

Everything that psychical researchers have been documenting for decades as poltergeist activity—and that priests have been called in to exorcise—eventually turned up in the laboratory where John Hutchison's device operated. Although it was made

up of different parts, it operated as a single entity, and phenomena occurred in the same unpredictable way as reported poltergeists: you could be there for days and nothing would happen, then suddenly coins would flip and fly, water would swirl and a transformer would blow. And this brings me to an unfortunate aspect of the device: it has a tendency to destroy itself. It is worth recalling at this point that psychical researchers have in fact dubbed poltergeist activity as "destructive haunting".

Therefore, I was vindicated in that it was clear that classical poltergeist phenomena are generated by EM field effects—but how? These were not conventional magnetic phenomena or those of ordinary static electricity which can disturb non-ferrous materials. And there were other unusual aspects that had to be taken into account: the effects that occurred were all at low power and at a distance.

On one video recording a 19-pound bronze cylinder is seen to rise majestically into the air, at a distance of 80 feet from the centre of the device, but, incredibly, Hutchison tells us:

"The source power was 110 volts AC. One side of the AC line had a power factor capacitor (60 cycles, 250 volts) and a 100-amp current limiter."

On another occasion, when Hutchison's layout of apparatus and equipment was reproduced by an electrical engineering company interested in this device, he explained:

"All components are powered from a single 15-amp, 110-volt, 60-Hz supply."

Everything that psychical researchers have been documenting for decades as poltergeist activity—and that priests have been called in to exorcise—eventually turned up in the laboratory where John Hutchison's device operated.

ELECTROMAGNETIC POWER TO THE PEOPLE

Before we examine aspects of Hutchison's device in more detail, let us remember that the aim of this article is to assist people around the world adapt to an accelerating transformation. As we can see from the recent increase in interest in the paranormal, understanding the implications of poltergeist phenomena would certainly qualify as a valuable goal.

Until now, the general public has been led to think of poltergeists as spectacular fiction, and, for many

decades, status quo psychical researchers have done little better by regarding this phenomenon as the activity of spirits of the dead or intelligences from the astral plane. At this stage of my career as an investigator of the paranormal, and at this stage in our developing awareness, which is an integral part of the generalised transformation, people are hungry for answers. They have had enough of regarding strange phenomena as permanent mysteries and want to move forward. We are at the crossroads. We can continue along the road where mysteries remain unknown and are kept as such by the traditional psychical research establishments (I cannot name them for fear of litigation), or we can seriously examine fresh alternatives which begin new directions that give some real hope for answers and understanding.

Many people in the UK and USA already know of my environmental causation approach to the paranormal and anomalies in general, by the movement I have launched in my books. If I were

to encapsulate my case in a single general statement, I would say this: that in the understanding of the paranormal, electromagnetics are as fundamental as genetics are to biology. However, as we will now see in the exploration of the Hutchison device, this certainly does not mean that if we identify poltergeists as electromagnetic in nature, we can all pack up and go home, mystery solved. In fact, the situation is the reverse as we can now enter realms of real scientific possibilities, although they do begin to sound like science fiction! That is to say, some very strange doors begin to open...

For example, part of the Hutchison effect literally rips half-inch-square steel bars apart and actually shreds the shattered ends (all at low power and at a distance, remember). Tremendous energies come from somewhere, and in his experiments with the disruption of metal masses in the laboratory, Hutchison has developed his own ideas. He wonders if somehow the fabric of space-time is actually breached. As he puts it:

"The idea is to excite the surface skin of the masses and their atoms to create an unstable space-time situation. This might allow the fields from the Tesla coils and RF-generation equipment to lock up in a local space-time situation. My thought is that now a small amount of energy is released from the vast reservoir in space-time at the sub-atomic level to create a disruptive or movement effect."

Suddenly we are considering the atomic physics of poltergeist activity! There are few things more exciting than to realise connections between areas that were previously thought to be entirely unconnected. We could eventually move on and devise experiments to test the limits of poltergeist activity—and then, the floodgates are open! We are moving through strange landscapes

that everyone had previously thought of as only vague possibilities.

Modern psychical researchers who regard themselves as insightful and progressive now say, "You know, in the future, what we now think of as the paranormal will be commonplace, and not only understood but actually used in our everyday lives; for example, to dematerialise objects in one location and rematerialise them in another." But this "future" has to begin somewhere, and it would appear that the application of electromagnetics to poltergeist activity is in fact this early beginning.

However, it is ironic that this discovery was not originated in state-of-the-art government physics laboratories by a highly qualified and experienced scientist, but by someone who is the classic individual experimenter and self-made physicist. John Hutchison began his personalised journey through electromagnetics at an early age and, by accident, discovered the unusual effects described. But let us continue by considering in more detail the phenomena his device can generate.

THE HUTCHISON EFFECT: A LIFT, DISRUPTION AND LUMINOUS ENERGY SYSTEM

The original way that Hutchison set out his range of apparatus was, by industrial standards, primitive and crowded, with poor connections and hand-wound coils. But it was with this layout with its erratic standards that he obtained most of the best examples of objects levitating, despite the fact that the maximum power drawn was 1.5 kilowatts, and this from the ordinary power sockets of the house mains.

The Hutchison device produces effects which can basically be divided into two categories, propulsive and energetic. It can

induce lift in objects made of any material and also propel them laterally. It has been noted that there are four types of trajectory that affect objects weighing a few pounds, and all of these upward movements begin with a twisting spiral movement. Also, there has to be a particular geometry in relation to the direction of gravity, i.e., downwards of these objects, for them to be affected in this way. Some objects will not take off if you turn them on their sides, but will if you stand them on their ends. It is evident, therefore, that the relationship of their physical forms to the fields which swirl invisibly around them is important.

Returning to the four modes of trajectory, first, there is the looping arc, where objects take off relatively slowly over a period of seconds, loop in the air and fall back to earth; then there is the ballistic take-off where objects shoot upwards suddenly, hit the ceiling and fall back down. A third type of trajectory is a powered one where there appears to be a continuous lifting force; and the fourth is where an object moves upwards and just hovers for some time. As mentioned, these objects can be of any material whatsoever—wood, plastics, copper, zinc, styrofoam, etc. It must be mentioned that 99 per cent of the time the objects do nothing at all, and one can wait for days before anything happens, but it is just this erratic unpredictability that one

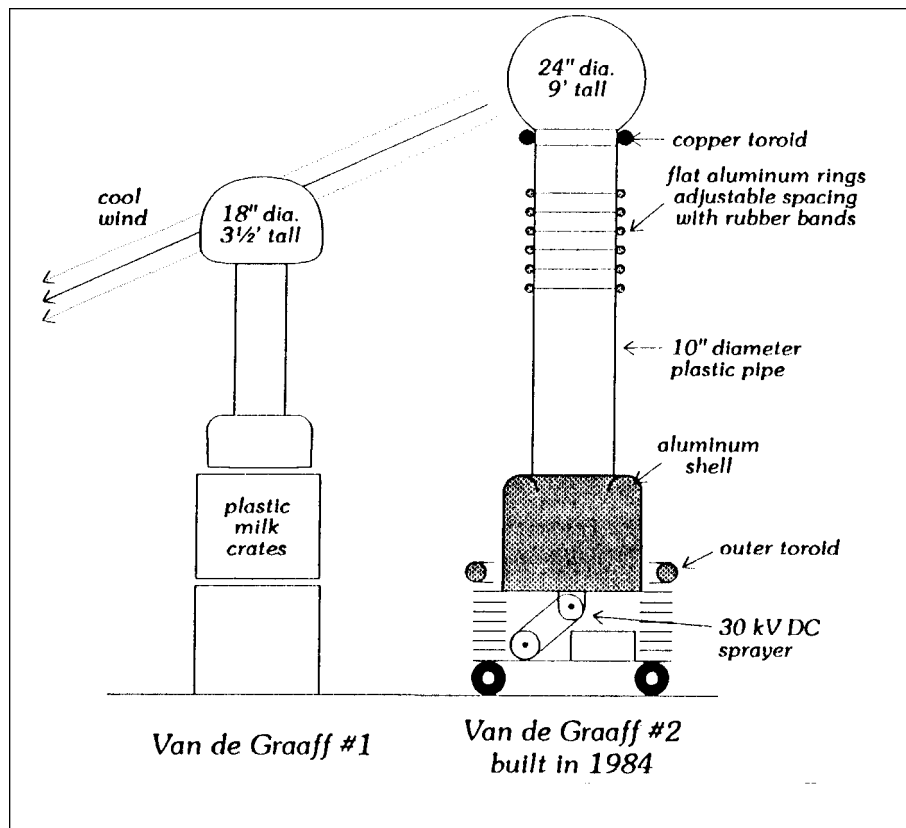

Diagrams showing two of the Van de Graaff generators that Hutchison uses—one about three times larger than the other. (This is of particular interest to me, as I have had several reports of a 'cold wind' felt at 'haunted' locations, and the fields produced using this configuration generate precisely the same effect. — A.B.)

finds when investigating poltergeist activity.

Another major area of activity is the disruptive phenomenon where materials are destroyed. Hutchison has a collection of metal samples which have been broken and/or deformed, indicating that high energy levels are involved, as mentioned before.

As one may imagine, this device has attracted intense interest from a variety of professional, academic and industrial sources, not to mention covert military attention.

In the USA, a respected and well-qualified electrical engineer, George Hathaway, has taken on the research and development of the device. As explained, although the device has many interrelated parts, it acts as a single entity. Of the disruptive effects on metals and other materials he relates:

"The disruption part of this...system has produced confirmatory physical samples that include water, aluminum, iron, steel, molybdenum, wood, copper, bronze, etc... We have tested various pieces that have broken apart, for hardness, ductility, etc. We have used optical and electron microscopes.

"Two samples of aluminum... one of which is twisted up in a left-handed spiral...and another which was blown into little fibres...molybdenum rods which are supposed to withstand temperatures of about 5,000 degrees F... We watched these things wiggle back and forth... In general, a collection of pieces of metal shows that they have been blasted apart or twisted..."

In domestic settings where 'poltergeist' activity is usually observed, metal-bending and deformities take place with less vigour—which is to be expected due to the accidental field configurations produced as electromagnetic pollution from power lines, radio transmitters, civilian radar, etc., interacts with Earth energies—otherwise known as geomagnetic and geoelectric fields—at locations inadvertently built over fault lines.

The following example taken from a well-known case in the UK—the Enfield poltergeist—shows a typical instance of metal-bending:

"It was 10.15 am on 6 December 1977. Janet was leaning on the kitchen worktop, and her mother was sitting down. Both were out of reach of the stove. Suddenly, they both heard a noise coming from the teapot—the same metal one that Grosse had seen rocking in front of his eyes. Mrs Harper picked up the pot and found that its stout metal lid had arched upwards, just as the spoons had done, bending right out of shape so that it no longer fitted the pot. I took the lid in both hands, and even using considerable force I was unable to bend it back."

Hathaway, in his descriptions of metal deformity, clearly gives the impression of intense energies at work:

"The largest piece [of metal] is about 12-13 inches long. It's

two inches in diameter, of regular mild steel, and a 3/8 of an inch long part was blasted off the end and crumbled like a cookie."

However, even the domestic 'poltergeist' displays phenomena where extremely high energy levels are involved, although in the following example, also from the Enfield case, we get the impression that more conventional high-magnetic-field densities are involved:

"Mr Playfair...was already on his feet and standing in the doorway of their bedroom, wondering if he was seeing things.

"The entire iron frame of the gas fire had been wrenched out of the wall, and was standing at an angle on the floor, still attached to the half-inch-diameter brass pipe that connected it to the mains. The pipe had been bent through an angle of thirty-two degrees. This was a major demolition job, for the thing was cemented into the brickwork, and it was out of the question to suggest that one of the children could have wrenched it out. When we finally dismantled the whole apparatus, we found it quite a job even to move. It must have weighed at least fifty pounds."³

We may ask ourselves what new directions for investigation into 'poltergeists' are open to us in the light of the Hutchison Effect. Startling as it may seem, an answer is there ready-made for us in the almost matter-of-fact information that Hathaway supplies:

"Fragments have been analysed and found to have an anomalously high silicon content, although the original material was not silicon steel...a standing piece is 5-6 inches tall, 1 and 1/4 inches in diameter and is a piece of case-hardened steel... The case-hardening has been blown off at the top and about 3/4 of an inch of it vaporized during an experiment...a piece of iron was analysed for composition which showed anomalously high amounts of copper...wood particles were also found inside a piece of aluminium..."

Evidently, the energies involved are able to reorganise materials in a way that is virtually impossible by any other means, but we are now provided with a previously

unheard-of perspective. From the Hutchison experiments, it is clear that an analysis of the composition of metals at the 'poltergeist' site, in order to detect similar mixture-anomalies, is an essential investigative procedure.

Although we may shelve theories of psychokinesis and separate them out from 'poltergeist' activity as belonging to dice-throwing experiments or the spoon-bending of Uri Geller, the weird physical antics of the mixing and matching fields of the Hutchison Effect provide us with something far stranger. This underscores the point made earlier that although it sounds as if the enigma of the 'poltergeist' is being diminished by identifying it as electromagnetic field activity, in actual fact the mystery is merely being redirected.

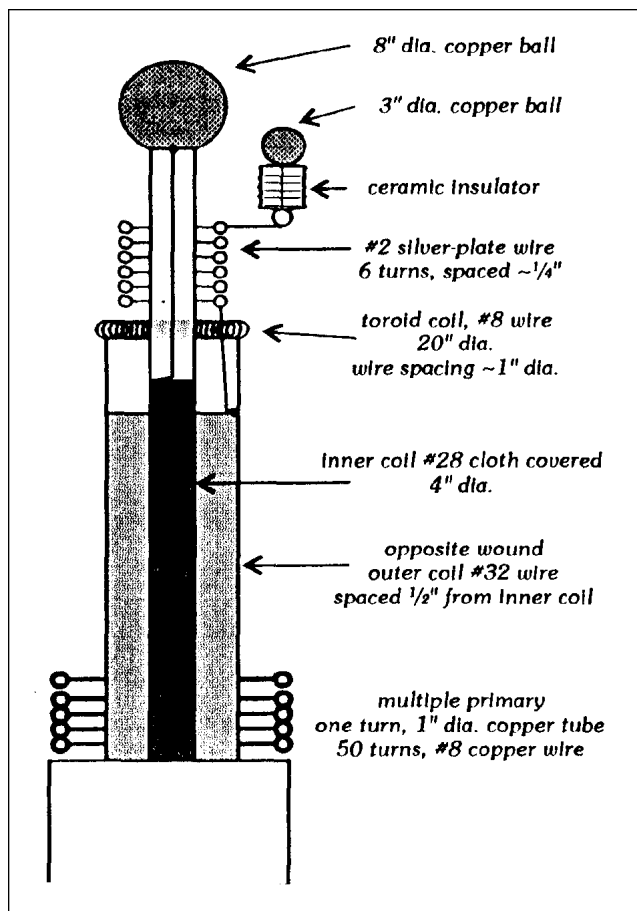

Diagram showing a seven-foot-tall Tesla coil, as used by Hutchison.

Physicists and electrical engineers should now reconsider the nature of severely modulated electromagnetic fields, for there are evidently previously unrealised potentials. The energies involved in the Hutchison Effect are clearly the same ones at work during 'poltergeist' activity, and it is only the ignorance and entrenched positions of the psychical research fraternity that prevent them from accepting these insights into electromagnetic energy potentials.

These energies include weird thermal effects. During Hutchison's experiments, flames have been produced and emitted from blocks of concrete, and fires have broken out in different parts of the building where the device was housed. Again, these effects are typical of 'poltergeist' reports. On one occasion, a steel file was held in place against a wooden board by two plywood struts, to prevent it taking off. The file glowed white-hot, but the board when examined afterwards was not even singed. Such mischievous thermal antics of 'phantom arsonists' have been attributed to the 'spirit energy of the poltergeist', whatever that may be, but Hathaway's warnings are more to do with effective safety practices in the laboratory:

"From time to time there are scorch marks on the boards from other experiments. The apparatus makes fire spontaneously in parts of the lab, if you're not careful."

The device can also induce unusual aurora-like lighting effects in mid-air. Once when Hutchison was filming in 1981, a sheet of iridescence suddenly descended between the camera and some of the hardware being used. It had a strange pinkish centre to it, and after it hovered there for a short period it vanished just as suddenly as it had appeared. Hutchison actually thought he had been hallucinating, but when the film was developed it transpired that there had actually been something objective there.

Once again, the Enfield case provides us with comparable examples of strange, luminous phenomena in a domestic setting, and in this extract they are accompanied by other typical phenomena also explainable within the Hutchison Effect:

"The Harpers hoped to find some peace and quiet in the Burcombes' house, but it was not to be. From the kitchen Sylvie suddenly let out a piercing scream and dropped the kettle she was holding. It was some time before she could calm down enough to describe what had happened. 'I was just pouring the water from the kettle into the teapot,' she said, 'when something appeared right in front of my eyes and then dropped onto the kitchen unit top, and bounced once.' It was a plastic rod, about six inches long, from one of the children's toy sets. 'I sort of looked down, opened my eyes, and this thing was in front of me,' she told Grosse when he arrived shortly afterwards. 'I screamed, shouted and jumped back, and after I jumped back I saw the thing jump and come up again.'

"Grosse questioned Mrs Burcombe very carefully about this incident, which seemed to be a genuine case of one of the rarest of all psychic phenomena: materialisation. The plastic rod had definitely not been thrown at her, she insisted. It had just appeared in front of her eyes and dropped down... But he had already seen too much, in both his own and his sister's homes. He had watched open-mouthed as a lamp slowly slid across a table and fell to the

floor, vibrating violently. He had seen a drawer open by itself. He had felt an invisible force stop him closing his own bedroom door, which simply stuck half-closed though it normally swung shut on its own. And he had seen something far more alarming as he stood one day at the bottom of the Harper's staircase, looking up it. 'I saw this light,' he said. 'It was the equivalent, I should say, of twelve inches vertical. It looked like a fluorescent light behind frosted glass, which burned fiercely and gradually faded away'..."⁴

With the insights gained from what is possible during operation of the Hutchison device, coupled with my own findings that 'poltergeist' activity takes place at locations that are electromagnetic hot-spots, we can begin to understand what is going on in such cases. Unusual light phenomena can occur, and on consulting Burke's *Handbook of Magnetic Phenomena* we find several mechanisms documented where magnetic fields interact with light to produce specific optical effects that are predictable in laboratory conditions, but are obviously most startling when they occur spontaneously in domestic settings. Having stated this, however, the sheet of iridescent light which appeared during Hutchison's experiments also came as an unexpected and surprising phenomenon.

In the extract given above, it is not difficult to rethink the apparent materialisation of the plastic rod as a typical trajectory of the Hutchison Effect, observed many times and recorded on video. Likewise, the lamp slowly sliding across the table and vibrating could have come straight out of the catalogue of effects similarly induced. In fact, compared with the extreme effects that Hutchison can obtain with his device, domestic 'poltergeist' phenomena which previously seemed so dramatic, now seem quite tame. But as already noted, this lessening of effect is consistent with the fact

"From time to time there are scorch marks on the boards from other experiments. The apparatus makes fire spontaneously in parts of the lab, if you're not careful."

that the Hutchison device involves a concentrated collection of devices which appear to act as a single entity, whereas an electromagnetic hot-spot occurs by the chance juxtaposition of freak environmental field sources.

Unfortunately, the investigators present during the 'poltergeist' activity at Green Street, Enfield, England, in the late 1970s, did not carry out a thorough field survey or identify the field sources involved, despite the fact that a magnetometer registered distinct deflections as objects were 'thrown' across the room. In fact, there is the distinct impression that, for them, electromagnetic fields were not a welcome explanation for the phenomena they witnessed, as the Playfair book relates how they discontinued use of the magnetometer once it showed that power surges occurred in conjunction with physical phenomena:

"When everybody was settled into bed, we switched on both tape recorders, Eduardo's being connected to the signal from the magnetometer, and left the room, since I had told him that nothing would happen if we both stayed there. From the landing we could keep an eye on the dial of the machine, and in the following forty minutes Janet's pillow was twice thrown across the room just as it had been the previous evening in my presence. This time, of course, I could not see Janet, although Mrs Harper assured me at

Continued on page 84



HIGH-TECH WEAPONS OF THE HINDU GODS

by Robert Goodman ©1996

The *Mahabharata* and the *Ramayana*, like almost all the great classics of India, describe many gods and demons. For the majority, these entities belong to the realms of mythology; but, for others, they are considered as real beings that existed in remote times. What is spoken about less, although mentioned in the above texts and the *Shastras* (Vedic science texts), is that these gods and demons possessed a variety of lethal weapons. Perhaps they were not divine but exceptional entities from this or some other planet.

The Wars of the Gods

If we look in the *Srimad Bhagavatam* by Krishna Dvaipayana Vyasa, we find the detailed description of a tremendous battle between the god Krishna and the demon Banasura, who at that time countered with the help of Shiva who commenced to fire his weapons at Krishna one by one without conquering him—thanks to Krishna neutralising them.

First of all, Krishna counteracted a *brahmastra* (similar to an atomic bomb) with a similar weapon, and a kind of "air-earth

missile" with another one of equal characteristics. When Shiva hurled his "hurricane-producing weapon" against Krishna, the latter neutralised it, unmoved by Shiva's new attempt to defeat him. The contest did not finish at this, so Shiva then used his "incendiary bomb" which Krishna again neutralised, this time with his "water bomb". The now angry Shiva then resorted to his personal weapon, the *pasupatastra*, which was subsequently destroyed by Krishna's *narayanaastra*. Krishna, taking advantage of a "lull in the storm", fired his "sleep-provoking weapon" at Banasura and Shiva, the latter becoming so lethargic that he refused to fight any longer.

At last, Krishna could fight against Banasura and his soldiers face to face. After a long and bloody battle, Shiva's allies left the battlefield, obliging the defeated god to use his ultimate deterrent, the *sivajvara*, a terrifying device that destroyed everything within its reach, producing temperatures 12 times greater than the Sun and whose shape (described as having three heads and three legs) reminds us of modern missiles with multiple heads and three tailfins. But not even this weapon could destroy Krishna, who neutralised it with his *narayanajvara* that released such an intense cold that the combination of the two opposite energies produced a tremendous explosion. The feroci-

ty of this battle was comparable to that of modern warfare, both for its destructive effects and for the variety of arms employed (no fewer than 10 are mentioned in the text).

But before considering if these arms were real or the imagination of the author of the *Mahabharata*, it is interesting to examine other Hindu texts. The *Mausola Parva*, for example, speaks about a death-ray that reduced entire armies to ashes in seconds and caused the hair and fingernails of any survivors to fall out. Even kitchen utensils broke for no apparent reason, birds' feathers turned white in very little time, and food became contaminated.

The effects of this ray remind us of those produced by the atomic and hydrogen bombs, cruelly dropped on Hiroshima and Nagasaki. Furthermore, another text, the *Drona Parva*, speaks about the launching of a shining projectile which, on falling to the ground, produced a thick mist in the sky, causing the "clouds" to "roar and spit" blood, while at the same time scorching the Earth's surface. Again, it seems that these descriptions are very similar to those of atomic explosions.

Among those researchers who claim that these stories are not legends we count Alexander Gorbovski, who, in his book, *Enigmas of Antiquity*, mentions a human skeleton found in India that had a very high

level of radioactivity—50 times greater than normal. This discovery seems to confirm the authenticity of the accounts in the *Mausola Parva* and *Drona Parva* texts.

Returning to the *Mahabharata* and its descriptions of battles, this time in chapters 168, 169 and 173 of one of its books, the *Vanaparvan*, the battle between Arjun and the *asuras* (demons) is mentioned:

"Arjun ascended to the heavens to obtain divine weapons from the celestial beings and learn how to use them. During his stay, Indra, Lord of the Heavens, ordered Arjun to destroy the *asuras'* army, consisting of thirty million demons living in fortresses in the depths of the seas. Indra, Lord of the Heavens, lent Arjun his own spacecraft, piloted by his able assistant Malati. The craft could also travel under the water. In the ensuing battle, the *asuras* caused terrible floods, but Arjun neutralised their efforts with a divine weapon, drying up all the water."

Previously, in Chapter 102 of the *Varnaparvan*, it is described how Arjun returned to the heavens with his amphibious flying machine and how he discovered a city that spun around its own axis in the middle of the space. This city was called Hiranyapura (the Golden City) and had been constructed by Brahma, but at the time was falling into the hands of the *asuras*. The next adventure entrusted to Arjun was to destroy Hiranyapura, but the *asuras* defended it with their potent weapons. The text relates:

"There was a terrible battle during which the city was violently thrown into space and then rocked from one side to the other. After a long struggle, Arjun launched a rocket, destroying the city and reducing it to smithereens, all of its pieces falling to Earth. The surviving *asuras* got up from among the ruins and continued fighting. But Arjun finished the battle, thanks to the potent *pasupata*. All the *asuras* were completely annihilated and Indra and the other gods welcomed Arjun as a great hero."

Such stories remind us of the battles developed in the film, *Star Wars*, except for the fact that the script was written 5,000 years ago.

In the opinion of Dileep Kumar Kanjilal, Professor of Sanskrit at the Institute of Sanskrit in Calcutta, the logical deduction that may be reached from these texts is that, thousands of years ago, the Earth must have known a civilisation with sufficient scientific knowledge to construct aircraft

and launch colonies into space. Such civilisations must have been destroyed by some unknown catastrophe, as recorded only in legends.

Atlantis vs the Rama Empire

According to the North American association the Lemurian Fellowship, Atlantis and the Rama Empire reached their greatest degree of grandeur at the same time. Both cultures had developed an advanced technology, competing with each other and with other civilisations. They not only countered with *vimana* aircraft but also with arms resembling "fire balls", capable of destroying entire cities.

Another weapon, known as "Kapila's Gance", could reduce more than 50,000 men to ashes in seconds. Last, but not least, they possessed "flying lances" (rockets?) that could destroy fortified cities.

The Lemurian Fellowship believes that when both cultures reached their zenith, war broke out between the people of Atlantis and the Rama Empire. The Atlanteans, determined to conquer the world and destroy their opponents at any cost, marched against the less-prepared Rama Empire and, on three occasions, invited its people to surrender. Three times the latter refused, obliging the Atlanteans to invade India.

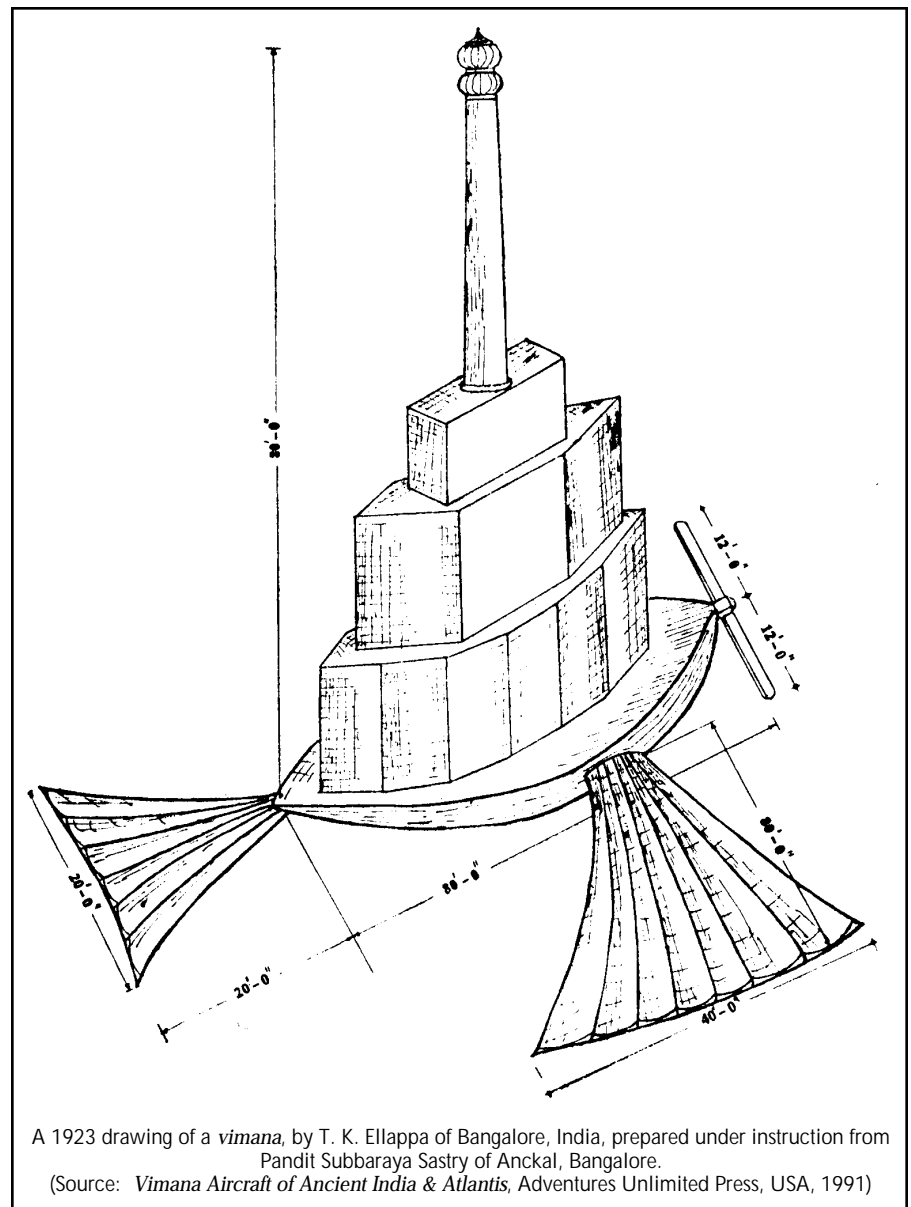

When Rama saw how the Atlantean soldiers marched towards the capital of his Empire, he raised his arms to the sky and concentrated the entire power of his mind—causing the general and all the officers of the Atlantean invasion to die on the spot. Without leaders, the Atlanteans were at a complete loss, so they returned to their aircraft and back to Atlantis.

This failure did not stop the Atlanteans. Throughout the *Mahabharata*, terrible scenes are narrated which Sanskrit scholars were unable to understand until the first atomic bombing of Japan.

The Nine Unknown Men: Science Fiction or Secret Science?

There exists no modern state without a secret service entrusted with keeping large amounts of classified documents away from the public. If this is 'normal' nowadays, it is understandable that important information on technology would also have been strongly guarded in ancient civilisations. Hence, it is not strange that lay men and women of today know little about scientific developments of the ancient past. But this does not mean that such information has not been passed down from generation to generation over the centuries.

Returning to ancient India, between 274-232 BC the great Emperor Ashok created a secret society of scientists called the Nine Unknown Men. Each member of this society was entrusted with the task of writing about one science, continuously updating it and maintaining it in secret. According to

the French writers Louis Pawels and Jacques Bergier, the first of these books dealt with techniques of propaganda and psychological warfare; the second, physiological attacks and, specifically, how to kill an enemy without touching him; the third book considered microbiology as a potential source of weapons; the fourth, the transmutation of metals; the fifth dealt with the study of different forms of terrestrial and extraterrestrial communication; the sixth, the secrets of gravity and how to overcome it; the seventh, cosmogony; the eighth, light and its manipulation for warfare purposes; and the ninth dealt with sociology and determined rules for the evolution of societies, also foreseeing their possible decadence.'

In his book, *Vimana Aircraft of Ancient India and Atlantis*, David H. Childress asks if the sixth book mentioned above was really a text on *vimanas*, called the *Vymanika Sastra*, written by Maharshi Bharadwaja. This Shastra was discovered in 1919 and translated into English in 1972. The text contains detailed instructions on how to manufacture aircraft.

The defence systems described in these texts demonstrate that the ancient Hindu civilisation, whose leaders were considered to be divine beings or gods, indeed had possession of extremely advanced technology.

(This article was first published in Mas Alla de la Ciencia [Monograph no. 17, June 1996], the Spanish journal dedicated to ancient technologies.)

THE MIRACLE STONES OF ALGECIRAS

by Robert Goodman ©1996

Healers have always been the target for study and even ridicule, but the particular case of a healer, Charo Alvarez, from the state of Cádiz in Spain, has attracted the interest not only of Spanish but also foreign journalists.

Until approximately seven years ago, Charo was a normal Spanish housewife, living in San Garcia, Algeciras, who had never been involved in any 'strange' circumstances and who would think twice before going to a healer.

In a recent conversation she told me her story. One fine day she awoke with an odd sensation: she was absolutely sure that she knew everything that was going to happen that day. Indeed, that same night she realised that everything had happened as she said it would. After this experience, she felt really worried and afraid. Until then, so-called paranormal phenomena were foreign to her and were something that happened to other people. Nevertheless, she gradually got used to her 'gift', and her premonitions continue right up to this day.

Charo then told me how she realised she was in telepathic communication with an entity from another dimension when she began receiving a series of messages leading her to what was going to become a new mission in her life: curing people. She explained that this mysterious 'spirit' identified itself as Sister Maria del Mar.

In Charo's own words: "I only have to think about her and she immediately establishes contact through automatic writing. At the beginning, Maria del Mar told me that near to my home there was a sacred site on a beach, full of very special stones that I had to find to be able to begin my mission of curing people. And the truth is, I found them. Later on, Maria del Mar taught me to communicate with the souls of incarnate persons through telepathy."

Charo told me that at first she did not know how she was going to become a healer as she had no idea whatsoever of anatomy, physiology or pathology of the human body that could serve as support for her new 'job'. But Maria del Mar told her not to worry as she would teach her how to connect with the different human organs and, above all, to find the stones.

Safe sects

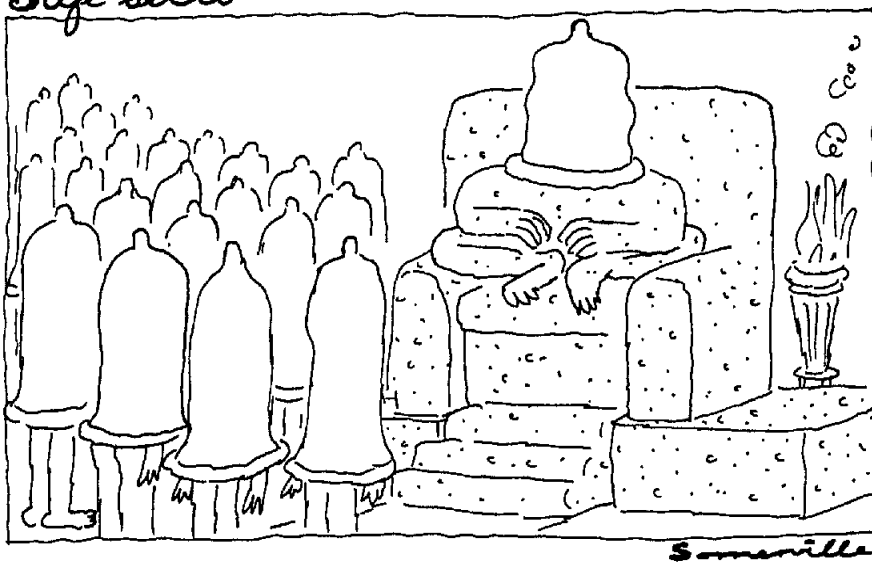

So Charo went to the local village beach of Chinarral where she found some stones with a strange characteristic: they had the shape of human organs. The most curious thing was that the edges of the different stones fitted into each other as if they were pieces of a jigsaw puzzle forming the entire human body. Moreover, on coming into contact with these stones, Charo felt that she was in contact with a real energy. From that day, Charo made many visits to the beach, supplying herself with stones and sea water—her 'instruments' of work as a healer.

She performs healings totally for free, not even accepting 'tips' from her patients. Her results are so spectacular that not a single day passes without dozens of people visiting her home in the hope of being cured from all types of illnesses.

When a patient visits Charo Alvarez for the first time, she invites him/her to sit in front of her on the other side of a table on which a volcanic rock has been placed. The patient then places his hands on this rock and closes his eyes while the healer recites some prayers. A few minutes afterwards, Charo already knows what is wrong with her patient and then gives him/her two healing stones and 2-3 litres of sea water. Apparently the treatment is identical for everybody. Each patient is instructed to take home the water and stones, place them in a suitable container and, during the following two weeks, rub the back of their hands with one of these 'magic' stones. And that's it.

One of the phenomena making this story different is the colour change of the water containing the stones. Apparently after eight or nine days of treatment, the sea water changes its crystalline blue colour to that of an opaque red or orange, resembling blood. To date, nobody has been able to explain this transformation, despite the water having been analysed in various Spanish and foreign laboratories.

Charo Alvarez has become so popular that her fame has crossed international frontiers. About a year ago, the English weekly, *Psychic News*, published an article about Charo Alvarez, with the title, "Spanish Healer's Sacred Stones Turn Blood-Red". The report provoked great interest in specialised circles—so much so that the director of Britain's Channel 4 TV program, *Schofield's Quest*, sent a film crew to Spain to look into the matter.

Charo Alvarez was interviewed and

filmed at her home by the television crew. Before returning to England, the reporter collected a sample of water that had been used in the cure of a patient and which apparently had taken on the colour of blood. The sample was sent to the chemical laboratories of the University of Birmingham for study. The interview as well as the preliminary results of the analysis were broadcast on *Schofield's Quest* on 3rd December 1995.

The results were quite disturbing, for the phenomenon in question had no explanation whatsoever. It could only be reported that the liquid contained a high concentration of amino acids, some of human origin, as well as extraordinarily high concentrations of gold, silver and copper.

As the laboratory analysis was non-conclusive, I thought it would be interesting to know Charo Alvarez's opinion.

Robert Goodman (RG): What relationship exists between the stones you use and the sea water?

Charo Alvarez (CA): I believe there is an exchange of positive and negative energies between the stones and the water. While the stones absorb negative energy from the patient's body, the water positively 'recharges' the stone in a continuous cycle. Regarding the healing process, this occurs in the patient's mind which sends the correct orders to the entire body for it to function correctly. Healing the mind, heals the body.

RG: What is the composition of the

stones used in healing? Have they any special component?

CA: They are completely normal and I collect them from Chinarral Beach, quite near here. They are mainly of flint, commonly used by Stone Age man to make his tools. And, like him, I also use them as my own working tools, as important elements in the healing process. And this comparison makes sense because, in those times, mankind knew how to cure the mind through the stones—at least this is what Maria del Mar communicated to me. In fact, she wants to reveal the secrets of that civilisation through me.

RG: The water analysis done by Birmingham University indicates the presence of human residues. Do you think this is a proof that your sacred stones absorb the negative energy from your patients?

CA: I am completely convinced. A few days ago I received a letter from Sarah Edwards, of *Schofield's Quest*, who told me that many healers wrote to the program after the broadcast, informing her that they had also experienced similar changes of colour in the water they use in their own treatments. And it would seem that the change progressively occurs as the illness disappears—the intensity of the colour depending on the final state of health of the patient.

(This is the abridged English-language version of an article first published in the Spanish journal, Mas Alla de la Ciencia, issue no. 89, May 1996.)

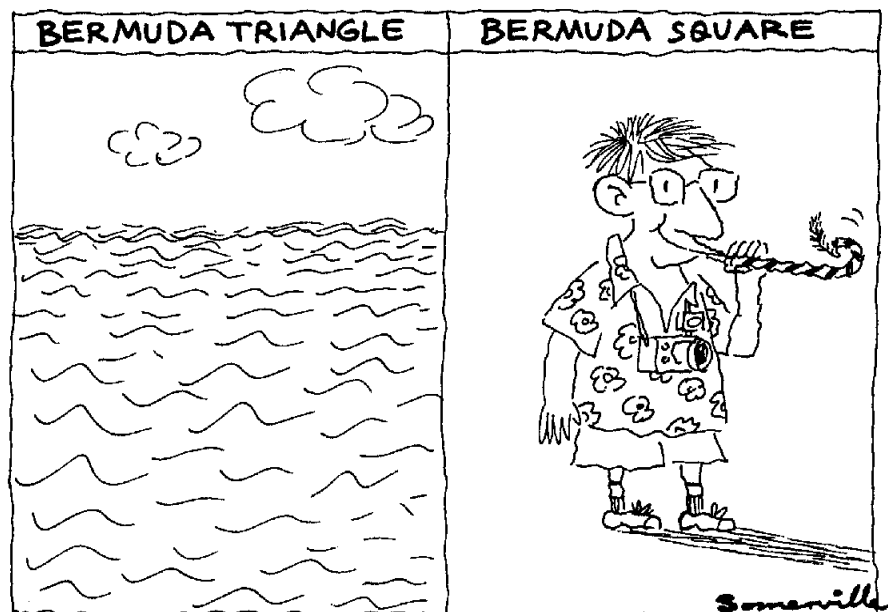

Native Elders Reveal Extraterrestrial Contacts

Tribal leaders claim their people have a common heritage with the Star Nations and a long history of communication with them. It is now time for their messages and prophecies to be shared among the Four Nations of Planet Earth.

by Richard J. Boylan, Ph.D.
©1996

2826 O Street, Suite 2
Sacramento, CA 95816, USA
Phone: +1 (916) 455 0120
E-mail: rich.boylan@24stex.com

For ten days in June 1996, the Yankton Sioux Reservation on the windswept high plains of South Dakota was a gathering-place for indigenous tribal leaders from around the globe and hundreds of Native and Euro-American listeners. The occasion was the Star Knowledge Conference and Sun Dance, convoked by Lakota (Sioux) spiritual leader Standing Elk in response to a vision. The vision showed that Native American spiritual knowledge about the Star Nations was to be shared. This Conference also fulfilled ancient Hopi and Lakota prophecies.

Spiritual shamans from the Pplains tribes (Lakota, Oglala, Dakota, Blackfoot, Nakota) were joined by spokespersons from the Eastern (Iroquois, Oneida, Seneca and Choctaw) and Southwestern (Hopi, Yaqui and Mayan) tribes. In addition, the chief Maori shaman came from New Zealand at the southern end of the world, as well as a spokeswoman for the Sammi (Laplander) people from above the Arctic Circle. They came because they had seen signs now occurring which had been predicted by ancient prophecies. These signs signified to them that the time had come to speak openly about their most closely-held oral traditions. These traditions include their origin from the stars, the influence of Star People visitors on the formation of their cultures, spiritual beliefs and ceremonies, and the imminent return of the Star Nations.

Unprecedented as this gathering was, a further precedent was set when Standing Elk, in a published announcement with apology to all Elders, declared that this sacred knowledge "is to be shared with our brothers of the four directions" (the entire non-Native world). Additionally, he invited world-famous Euro-American experts on extraterrestrials to speak at this gathering of Elders. Among those who spoke were such notables as: former NATO intelligence officer Sgt Major Bob Dean; Professor John Mack, M.D., of Harvard; author Whitley Strieber; CSETI assistant director, Martin Keller; former acting Finnish Surgeon-General, Rauni Kilde, M.D.; Professor Leo Sprinkle, Ph.D.; ET research psychologist Richard Boylan, Ph.D.; Professor Courtney Brown, Ph.D.; Italian stigmata-experiencer, Giorgio Bongiovanni; German researcher Michael Hesemann; former CIA paranormal operatives Dea Martin and Derrel Sims; and contactees Marilyn Carlson and Randolph Winters.

This report is a summary of the Star Knowledge Conference. As such, it will necessarily not cover every topic or every speaker. Furthermore, because Native speakers have not presented their messages publicly before, while the Euro-American experts have been widely reported, this report will focus on the Native revelations.

Standing Elk, Lakota Keeper of the Six-Pointed Star Nation Altar, in his opening remarks noted that medicine men have the ability to communicate with the spiritual entities of Mother Earth, such as the eagle, deer and coyote, and the Star Nations:

"The Star Nations were the most crucial of all entities, because the thought of other races communicating with the grassroots [indigenous] people would create a major threat to the religious systems [and] the economy and educational system of any government. The greatest fear in the governmental structures was the knowledge that all forms of 'Star governments' had no monetary systems within their governing structures. Their system was based on the mental, spiritual and universal laws which they were too mentally and spiritually intelligent to break. The collapse of the monetary system within the United States Government and the religious denominations became a national security issue, and so it became an easier task to make the Lakota/Dakota belief system illegal to participate [in] and practise."

Standing Elk added that "The Lakota/Dakota medicine men are now being instructed to share the spiritual knowledge of the Star Nations because of the contamination of Mother

Earth and the pollution of the air."

He spoke of witnessing, as a child, UFOs flying down the nearby Missouri River valley—green balls of light four times larger than a school auditorium. Through portholes on the sides of these ships he could see shadows of persons inside. During one encounter he met a seven-foot-tall man in white clothes who looked like a middle-aged Caucasian. The room was filled with light. It contained computer-like machines which operated on light and "the law of thought".

Standing Elk talked about meeting another Sioux medicine man who confirmed that ETs exist. Some are like ants, with big, black eyes and long fingers and toes. Some live out in the cosmos, and some on the other side of the Moon. Sioux legends relate that they came from the Pleiades, but that others came from the Sirius and Orion systems. He related how he'd had visitations in the sweat lodge from the "Grey" ETs who bore messages and provided answers to questions. Standing Elk talked about being visited by a five-foot-tall, orange-skinned extraterrestrial with large eyes. He also mentioned blue and green Star People and "a hundred other races you don't know about". He asserted that "the way of the Stars is in every culture".

Moving to a religious theme, he said that Jesus was a Star Man. Standing Elk noted that the symbols found on the "Roswell" UFO crash wreckage had two meanings: a universal law and a spiritual law. During a subsequent presentation he gave interpretations of the various ET symbols he had received from Star People who manifested during sweat lodge ceremonies.

The next speaker, Oglala spiritual advisor Floyd Hand, continued the religious theme, speaking about the avatars (world religious teachers) such as Jesus, Buddha, Mohammed, and White Buffalo Calf Woman (the Star Person who gave the Sioux their spiritual history, health practices and ceremonies). "The Avatars are Star People". He said that seven different

galaxies are represented on the Earth and that "Each Native American tribe has its ET race [its origination counterpart]." The Star People, he said, will return in the latter part of the 1990s. Changes will happen as their time draws near. The first signs are floods, fires and earthquakes. He said there will be a worldwide "great drought" in 1997-1999, and that many will starve. There will be destruction of electrical and sewer lines, loss of cities and many lives. He also said that in 1998, White Buffalo Calf Woman is coming back to Turtle Island (the US).

Floyd Hand spoke of the Four Omens. The First Omen was the recent birth of a white buffalo calf on a white ranch, whose hide eventually turned the other three colours of the Four Nations (yellow, red and black). The Second Omen was the birth of another white buffalo calf to a Sioux rancher, but the calf subsequently died. "We have no right to destroy four-leggeds and winged creatures for our purposes," he said. The Third Omen was a third white calf, with no one listening despite the human suffering and death. The Fourth Omen will be the Star People coming and visiting in Santa Fe, New Mexico.

Hand urged people to get away from urban hubbub and sharpen their senses: "Start putting in a garden, put away food; it's going to be hard. There will be a new government." He sees the end of the current world on 21st January 2021.

Elder Paula Underwood gave an Iroquois perspective on off-

planet life-forms. She described the many appearance-forms of the extraterrestrials. In answer to the question of whether we can form community with them, she replied that "...all who walk on two legs are our brothers and sisters. We come from the unity of the Universe." Underwood told of an Iroquois oral tradition of an ET telepathic message to the Iroquois: "We are coming." The Iroquois Elders thought-responded: "Don't come; we are not prepared." The ETs replied, "Prepare yourselves."

Lakota Elder Harry Charger discussed the oral tradition of the Sioux peoples. The Sioux have had many ET visitations during sweat lodge ceremonies. Charger said that 50 per cent of what we see as ET appearances are mental projections from the ETs. He said that the Star Nations are concerned about our destruction of the planet. He told of, as a boy, being instructed by his grandmother to make a ball that didn't bounce. Later, the village grandmothers gathered to try out tossing this gentle-landing ball he'd made. They smiled with satisfaction as it soft-landed. Years later he realised the point: that the soft-landing ball was a ritual re-enactment of a space vehicle which had touched down on the Lakota lands.

The Lakota Elder told the Sioux spiritual origin legend. Two Lakota scouts were out away from the tribe when a young, beautiful, pale-white, luminous woman appeared to them. She was White Buffalo Calf Woman. She gave them important instructions about their origin, as well as spiritual teachings and ceremonies to take back to their people. One scout had lustful thoughts for the woman and sought to approach her erotically, but he perished. The other scout paid respectful attention and brought back her teachings to the people, who were sustained by them. Charger said that each of us faces the same choice: how will we react to the return of the Star People's presence?

Finnish physician Rauni-Leena Kilde spoke of experiences with extraterrestrials during her upbringing

among the Sammi (Laplander) people above the Arctic Circle in Scandinavia. Her first remembered contact was when she was in a severe car crash. As she lay there mortally injured, a small ET was at her side working on healing her injured liver. Later, the hospital staff could not understand how she managed to survive the crash. It was after this that she remembered ET contacts as a child living among the Sammi.

Dr Kilde reported that there is a change of attitude in Scandinavia and the European Union concerning cosmic contacts; indeed, she hears many positive reactions to ET encounters. In Scandinavia, the so-called "Grey" aliens are rare. Most common there are the small, short, wrinkled "Dwarf" ETs. Her country borders Russia, where cosmonauts were threatened with death if they talked openly about UFO encounters.

Steve Red Buffalo (Lakota) gave a talk about the Star People coming down from the Pleiades ("Seven Sisters") constellation—the same one from which the Sioux trace their origin. The Pleiades have a connection with the *chanupa*, the sacred pipe which symbolises the union of the Earth (stone bowl) with the sky (hollow stem through which smoke is drawn and sent heavenward).

Dakota spiritual leader Chanupa Wambdi Wicasa (Deer Man) startled listeners by stating that the current Pope, John Paul II, is a Pipe Carrier (a Native-American spiritual tradition-keeper).

The Star People, he said, will return in the latter part of the 1990s. Changes will happen as their time draws near. The first signs are floods, fires and earthquakes.

While visiting Canada, the Pope fasted and entered into a sweat lodge ceremony with the Dakota, and congratulated them for keeping their traditions and ceremonies.

Deer Man interpreted a recent crop circle design as containing a highly relevant message. This crop circle consists of five concentric circles. The first four circles are like orbit paths around a central sun, with a planet-like 'bead' embedded in each orbit circle except the third one. The outermost ring is a chain of densely-packed 'beads' of varying sizes. The entire crop circle is the Circle of Life. The four inner circles represent the traditional Four Nations of humanity: White, Black, Red and Yellow. The smallest circle near the nucleus represents the White Race, but the elliptical orbit indicates that it is out of balance. Spirit gave the White Race responsibility for fire, but white man forgot his responsibility when he created the nuclear bomb. The second orbit is the Black Race, which has responsibility for water. But the Black Race has forgotten this and, as a result, the waters are contaminated, causing cancer. The third orbit, with 'planet bead' missing, signifies the Red Race which is responsible for the Earth. Its 'bead' is missing because it still walks with the Tunkashilas (Grandfathers, spiritual guides). The fourth orbit is the Yellow Race, whose responsibility is the air. But Asian-sponsored factories continue to pollute the air. Deer Man commented that "we have brought these imbalances on ourselves. The Red Race has responsibility for the land, but cannot do so because of herbicides, acid rain and underground nuclear testing."

Spirit told Deer Man that the other races were to have followed the red way of life too, but they lost it. The outermost circle represents the Star Nations. "The Star Nations are here to help us." The Earth was out of balance, and is rebalancing its tilt. "We have to help the Earth come back into balance. Time as you know it is coming to an end, sooner than you think. There will not be cars or TVs." He said that the Grandfathers taught him that we are coming to the end of the Fourth World and are about to enter the Fifth World. (This concurs with similar Hopi prophecies.) "It will take Nine Worlds before we get to the Spirit World."

Hopi Grandfather Titus, Keeper of the Prophecy Tablets, adopted Roy Little Sun. Speaking on behalf of his grandfather, Little Sun told of a solar system planetary alignment sequence moving into place, which is powerful for the Earth as the outer planets line up with the planets near Earth. "The power of the heavens steps down to the Earth. The New Moon [coinciding with the Conference conclusion on 16th June] is an opening of a gate of Star Knowledge." Little Sun said that the Star Knowledge Conference is like a medicine wheel; its participants will radiate out to spread the information to others, "taking the teachings of the Star People and applying them to human interactions".

Norbert Running, a Lakota Medicine Man, was one of the first to participate in the revived Sun Dance of modern times. He chastised latter-day Native American "neo-traditionalists" for being contaminated by Christian missionaries, believing in devils and making up bureaucratic religious rules. Norbert Running said that most Indians on the reservations believe in the natural way of spirituality. He urged everyone to "cultivate Spirit Guides to help you in the life path", and added that he'd learnt most of what he knows in the *yuwipi* (spirit calling-in) ceremony. He told of the

legendary Sioux Elder Black Elk having a prophetic vision of racial unity, a rainbow lodge with the Four Nations together, and also spoke of the Hopi prophecy of Red and White brothers working together.

The chief Spiritual Elder of all the Maori people of Aotearoa (New Zealand), Mac Wiremu Ruka, accepted Standing Elk's invitation to share the ancient truths and prophecies of his people. From the age of three, Elder Ruka was taught the genealogies, secrets and incantations of the cosmic and Earth realms. A special star alignment in 1988 told the old Maori Grandmothers that the time had arrived to make public the Old Stories which had been kept hidden for centuries. Elder Ruka was the one designated to speak. The Maori Elder related accounts of the star origin of his people. In a moving, candle-lit ritual, he created a twelve-woman ceremonial circle to speak for Spirit and set the proper vibration for creating such awareness.

Choctaw Medicine Man Panther (Preston Scott) told of how he was designated to follow the path of the *heyoka* (sacred trickster). One day as a boy he was being walked to school by his mother when a dark stormcloud came up from the west. His mother told him to run to his grandfather's house, but he only made it as far as his grandfather's yard when a lightning bolt struck so close to him that the heat and energy flipped him over. He landed on his feet, still running, and went up on his grandfather's porch. Being struck by lightning means Spirit designation as *heyoka*.

As an adult, Panther was climbing a hill one day and received a vision of three Grandfathers. He was told that he was going to go north to the Lakota land, where they would give him a foundation of spiritual knowledge to take back to his people, because the Choctaw had lost their spiritual ways. Now he is seeing spirituality rising among the Choctaw.

An *inipi* (sweat lodge) ceremony for a Sun Dancer was led by Panther on the night of 15th June. As we

prayed inside the totally-dark lodge, there appeared two rectangular-shaped lights, about the size of bricks, dancing near the upper eastern wall. Panther commented that there were six spirits inside the lodge. After the lodge we learned from others waiting outside that, during the sweat lodge, a UFO travelled high across the sky. At first it looked like a satellite, but then it stopped and gyrated in geometric patterns of flight.

Gary Holy Bull, a Lakota Medicine Man, is a carrier of the Elk medicine bundle. His spiritual path was deepened when he almost died while undergoing brain surgery. He had an out-of-body-experience where he met an old Indian medicine man adjusting energy particles coming out of people's bodies.

Holy Bull told of seeing UFOs flying over Bear Butte, a volcanic peak in the Black Hills and the sacred heart of the Sioux Nation. Then he spoke about the Star Nation Altars—the sacred ritual-object altars kept by certain designated spiritual leaders as shrines where knowledge of the Star People is gathered, kept and honoured. The Lakota Elder said that Star Nation Altars send up to the heavens a blue light which the Star People see as a beacon. He told of performing a ceremony for a woman, during which a Star Elder came in and landed nearby. The ET was tall and grey, and had large eyes. Holy Bull did the calling-in song, and the Tunkashilas (Grandfather Spirits) came in, went over and held the Star Elder. The Star Elder told them that Mother Earth is dying

A special star alignment in 1988 told the old Maori Grandmothers that the time had arrived to make public the Old Stories which had been kept hidden for centuries.

and that his (the Star Elder's) planet is already dead and lifeless. He said he was telling this to Holy Bull because the Native Americans have the Spirit. The Star Elder also said that Mother Earth will clean the ozone.

Gary Holy Bull had a dream one year ago, advising him to go to a spiritual gathering where sacred bundles and pipes would be placed together. That dream was fulfilled on 23rd June at Greengrass, South Dakota, when, in an unprecedented joining, the three sacred bundles of the Sioux (the pipe), the Cheyenne (arrows) and the Arapaho (sacred hat) were brought together. This fulfilled a prophecy about the beginning of the Thousand Years of Peace.

Rod Shenandoah, a Blackfoot-Oneida medicine man, in a side lecture during the Sun Dance ceremonies, talked about the visitations from the Star People which he, Wallace Black Elk, and many other medicine persons, chiefs and other Native Americans have experienced. He pointed out that "Indians consider themselves privileged" when such Star Nation contacts occur, and they regard such visits to be sacred events. Wallace Black Elk was visited by extraterrestrials while he was in isolation on a spiritual *hanblechia* (a fast and vision quest).

In a final teaching-round adjacent to the Sun Dance, Standing Elk said that the Star People are here to teach, to foster spiritual growth and to prepare us for dealing with the challenging Earth changes coming up in the next several years. The Star People are included as honoured Elders in the Native American key reverential saying, "*Mitakuye oyasin!*" ("All my relations!").

Standing Elk spoke of the extraterrestrials communicating telepathically with Indians, and that the original spiritual language of the Sioux was a language of a few cryptic keywords, designed to stimulate, and be supplemented by, full telepathic communication. The same Star People who visit the Sioux also visit the Hopi Indians. He said that the Star People and the Indians have the same DNA. Standing Elk noted that there is "big news" coming: "...fast changes, but they are slow in arriving." He commented that the Star People are also aware of the law of karma. Thus, the

rogue ETs (the few renegades who have collaborated with the shadow government) "are busy now, putting their act together".

Arvol Looking Horse, the 19th-generation Keeper of the Sacred White Buffalo Calf Pipe for the Lakota-Dakota-Nakota Nation, had called for a World Peace and Prayer Day on 21st June, the summer solstice. This was in response to prophecies shared by spiritual leaders and Elders at the United Nations, that it is time to begin global healing by working towards world peace and harmony.

While Looking Horse, the other sacred bundle-keepers and many others gathered at Grey Horn Butte (Devil's Tower National Monument), Standing Elk and those participating in the Sun Dance on the Yankton Sioux Reservation held an observance in support. As representatives of the Four Nations stood in the Four Directions doorways of the Sun Dance, and the gathered dancers and participants prayed, high above the central Sun Dance pole a thin, hollow circle of cirrus cloud formed around the Sun, refracting within itself a perfectly circular rainbow. Although the

wind was up from the west and other scattered clouds blew by, the circular rainbow remained perfect and immobile for over an hour, as witnessed by all the participants. In the Bible, the rainbow is described as a sign of peaceful favour from the one the Indians know as the Great Spirit. Perhaps Tunkashila was indicating that we can approach the end of the Fourth World and our emergence into the Fifth World with hope.

Note:

Videotapes and audiotapes featuring the Conference speakers are available for US\$29 or US\$12 respectively, postpaid, from Standing Elk, PO Box 262, Marty, SD 57361, USA. Please specify speaker(s).

About the Author:

Richard J. Boylan, Ph.D., is a behavioural scientist, clinical hypnotherapist, consultant, researcher, and author of four books and over 30 articles. He is a consultant to persons exploring personal growth and transformation issues as well as ET and other anomalous experiences.

In 1989 Dr Boylan began to investigate the phenomenon of human-extraterrestrial contacts. He has presented papers on his research at the 1992 MIT Abduction Study Conference, and at the 1995 Cosmic Cultures International Conference in Washington, DC.

He is a founding director of the Academy of Clinical Close Encounter Therapists (ACCET) Inc., an educational and networking organisation.

Dr Boylan's four books are *Extraterrestrial Contact and Human Responses* (1992), *Close Extraterrestrial Encounters* (1994), *Labored Journey to the Stars* (1996), and *Project Epiphany* (soon to be published).

He pointed out that "Indians consider themselves privileged" when such Star Nation contacts occur, and they regard such visits to be sacred events.

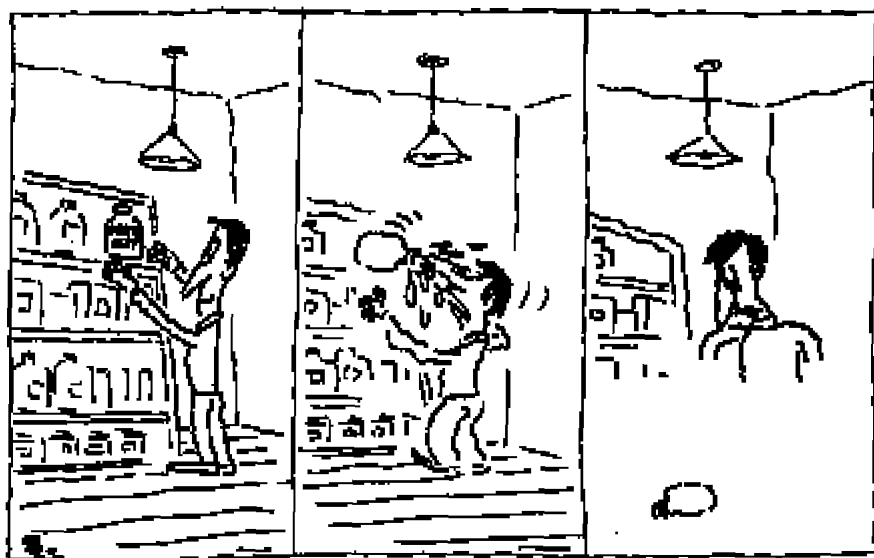



REVIEWS

BOOKS

Reviewed by Ruth Parnell

NASA, NAZIS & JFK: The Torbitt Document & The Kennedy Assassination

Introduction by Kenn Thomas

Published by Adventures Unlimited Press (1996), Kempton, IL, USA

ISBN 0-932813-39-9 (249pp s/c)

Price: AUD\$25.00; NZD\$34.00 + p&h;

STG£13.95; USD\$16.00 + p&h

Available: **Australia**—NEXUS Magazine,

ph (07) 5442 9280, fax (07) 5442 9381;

NZ—NEXUS Office, ph (09) 416 7320,

fax (09) 416 7340; **UK**—NEXUS Office,

ph 01342 322854, fax 01342 324574;

USA—Adventures Unlimited, PO Box 74,

Kempton, IL 60946, ph (815) 253 6390,

fax (815) 253 6300.

In 1970, a photocopied document, "Nomenclature of an Assassination Cabal", was circulated on a small scale among conspiracy researchers. The document was written by William Torbitt (not his real name), supposedly a lawyer from the American southwest. It is now reprinted in book form and at last readily accessible.

The allegations made in the Torbitt Document are damning and they reveal a far grander conspiracy surrounding the JFK assassination. The document outlines the powerful role of the military-industrial complex, and highlights connections to NASA's space program and the former Nazi rocket scientist Werner von Braun, recruited under *Operation Paperclip*, who headed up the little-known Defense Industrial Security Command. Intriguing details surface on the the top-secret Area 51 in Nevada, the possi-

bility of a faked Moon mission, and a NWO agenda involving ETs and off-planet bases.

Torbitt's document is expanded with introduction and bibliography from *Steamshovel Press* editor Kenn Thomas, and supported by some rare and revealing photographs including the famous Thomas/LBJ 'wink' photo.

FROM THE ASHES OF ANGELS: The Forbidden Legacy of a Fallen Race

by Andrew Collins

Published by Michael Joseph Ltd/Penguin

Group (1996), London, UK

ISBN 0-7181-4132-6 (461pp h/c)

Price: AUD\$29.95; NZD\$49.95;

STG£16.99; USD\$38.95; CAN\$29.99

Available: **Aust**—Cameron Books Pty

Ltd, 68 Winbourne Rd, Hazelbrook,

NSW 2779, ph/fax (047) 58 7676;

Sydney Esoteric Bookshop, 408 Elizabeth

St, Surry Hills, NSW 2010, ph (02) 9212

2225, fax (02) 9212 2448; **NZ**—Penguin,

ph (09) 444 4965; **UK**—Penguin, ph

0171 416 3200; **USA/Canada**—Books

Britain, ph (212) 749 4713.

Civilisation is the legacy of a lost, advanced race of beings whose existence is the stuff of myth and legend, according to Andrew Collins, for whom *From The Ashes of Angels* is the culmination of a 10-year study of the archaeology and pre-history of Egypt and the Near East.

But far from being the 'fallen angels' of mythology, Collins maintains that these beings—the Watchers—were a flesh-and-blood race. They were extremely tall with viper-like features, and practised shamanic magic. Their efforts to nurture a high civilisation were cut short at the end of the last ice age, c.9000 BC, when geological and cli-

matic disasters forced them to flee Egypt to safer ground—Kurdistan, in fact. Collins cites evidence for their existence in the Dead Sea Scrolls, in the Judaic Book of Enoch, in ancient Persian texts and in strange artefacts found in northern Iraq and Turkey.

Typically, the organised religions have tried to suppress this truth about their existence and their influence on human development.

Collins concludes that Kurdistan became the Watchers' new home base, or Eden, where they continued as an insular colony for 4,000 years before they again became integrated with developing human society. They appear to have left behind a clear warning that cataclysmic fate could befall future civilisations.

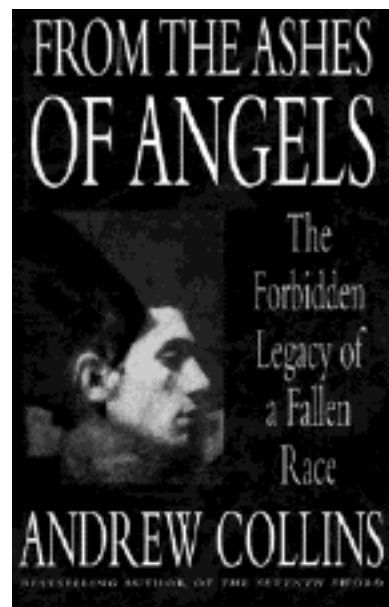

REVIEWS



BOOKS

THE GREAT BOOK OF HEMP

by Rowan Robinson

Published by Park Street Press (1996),
Rochester, VT, USA

ISBN 0-89281-541-8 (255pp s/c)

Price: AUD\$29.95; NZD\$49.95;

STG£15.99; USD\$19.95 + USD\$3.00

p&h; CAN\$28.00 + p&h

Available: **Aust**—Cameron Books, ph/fax

(047) 58 7676; Sydney Esoteric

Bookshop, ph (02) 9212 2225; **NZ**—

Tandem Press, ph (09) 480 1452, fax (09)

480 1455; **UK**—Deep Books, ph 0171

232 2747; **USA**—Inner Traditions, ph

(802) 767 3174, 1-800 246 8648;

Canada—Publishers Group West, ph
(416) 504 3900.

Cannabis, or Indian hemp, the most maligned and misunderstood plant of the 20th century, has been the most important and useful plant through history. It has been used in the pursuit of spiritual enlightenment and, as mankind's first fibre crop, has been the economic foundation of civilisations. The oldest hemp fibres were discovered in a tomb at Çatal Hüyük dating back to 8,000 BC, and evidence from ancient Egypt, India and China suggests that hemp and hemp seed oil were prized for their medicinal benefits.

Made into sailcloth and rigging, hemp assisted in Columbus' discovery of the New World; and, made into paper, it bore the immortal words of the US Declaration of Independence and Constitution. It was even the common means of exchange in the Americas until the early 1800s.

The Great Book of Hemp documents this

plant's glorious heritage, in juxtaposition with the conspiratorial moves to hinder technological advances in harvesting and processing, the insidious banning of the plant with the US *Marihuana Tax Act* of 1937, its brief re-emergence for the war effort, and its McCarthyist clampdown. Fortunately, attempts to redress this madness are underway in several countries where commercial hemp production is now legal and hemp is being recognised for its commercial, medicinal and environmental value.

This book contains plenty of resource info (for North America and Europe) for anyone wanting to participate in reinstating the most useful plant in the world to its former glory.

TOP SECRET/MAJIC

by Stanton T. Friedman

Published by Marlowe & Company

(1996), New York, USA

ISBN 1-56924-830-3 (286pp h/c)

Price: AUD\$45.00; STG£20.99;

USD\$22.95; CAN\$32.50

Available: **Aust**—Cameron Books, ph/fax

(047) 58 7676; Sydney Esoteric

Bookshop, ph (02) 9212 2225; **UK**—

Gazelle Book Services, ph 01524 68765;

USA/Canada—Publishers Group West,
ph (416) 504 3900.

In 1984, when a document referring to the mysterious Majestic-12 was leaked to him, nuclear physicist/professional ufologist Stanton Friedman embarked on a new mission. His latest book, *Top Secret/Majic*, is the result of 12 years of research into the MJ-12 documents concerning the recovery of a crashed UFO at Corona near Roswell, New Mexico, in 1947 and the establishment of a top-level group by President Truman to deal with the saucer and its alien inhabitants.

Friedman has painstakingly searched through 15 document archives for background and cross-referencing on MJ-12 members. The cast includes the first four directors of the CIA, various military leaders and several outstanding scientists including the Harvard astronomer Dr Donald Menzel who was a public debunker of UFOs, yet had a long-term association with the NSA and CIA. Many of these documents are published in this book for the first time.

Friedman is well-placed to research the Majestic-12 mystery for, in 1978, he was the first to begin seriously investigating the so-called Roswell incident, eventually publishing his findings in his book, *Crash at Corona*. Yet, for the conclusions he makes about these documents, Friedman continues to incur the wrath of many UFO researchers who make desperate attempts to discredit him and debunk the validity of the documents. Nevertheless, thanks to Friedman, some of the truth is at last being uncovered.





REVIEWS

BOOKS

BLOODLINE OF THE HOLY GRAIL: The Hidden Lineage of Jesus Revealed by Laurence Gardner

Published by Element Books (1996), UK ISBN 1-85230-870-2 (510pp h/c)
Price: AUD\$34.95; NZD\$49.95;
STG£16.99; USD\$29.95; CAN\$39.99
Available: **Aust**—Cameron Books, ph/fax (047) 58 7676; Sydney Esoteric Bookshop, ph (02) 9212 2225; **NZ**—Forrester Books, ph (09) 444 1948; **UK**—Penguin Books, ph 0181 899 4000; **USA/Canada**—Books Britain, ph (212) 749 4713.

The allegation that Jesus married and had children—and that his descendants are still alive today—first received public attention in 1982 with the release of controversial bestseller, *The Holy Blood and The Holy Grail*, by Baigent, Leigh and Lincoln. But where this book leaves off, *Bloodline of the Holy Grail* only begins.

This extraordinary book gives a detailed genealogical account of the authentic line of succession from the sons of Jesus and his brother James, through centuries of royal houses down to recent times. Distinguished author Laurence Gardner was granted privileged access to European Sovereign and Noble archives as well as Chivalric and Church records. He has uncovered documentation proving that knowledge of this sacred lineage has been systematically suppressed. Moreover, he has exposed a multitude of errors deliberately written into the history books through the ages.

Gardner provides a thorough analysis of the origins of the Bloodline and traces the

descent of Jesus from King David. He examines the real truth behind the Arthurian legends and the Holy Grail as well as the role of the Knights Templar in preserving the Grail legacy. The trail winds its way to the Royal House of Stewart and beyond in a conspiracy that reverberated across the Atlantic—and still resounds today.

This is a most scholarly, awe-inspiring work, further supported by a wealth of photographs, maps and genealogical charts.

THE RIDDLE OF THE PACIFIC by John Macmillan Brown

Published by Adventures Unlimited Press (1996), USA (first published by T. Fisher Unwin Ltd, London, UK, 1924)
ISBN 0-932813-29-1 (325pp s/c)
Price: AUD\$28.00; NZD\$32.00 + p&h;
STG£13.95 + p&h; USD\$16.95 + p&h
Available: **Aust**—NEXUS Magazine, ph (07) 5442 9280, fax (07) 5442 9381; **NZ**—NEXUS Office, ph (09) 416 7320, fax (09) 416 7340; **UK**—NEXUS Office, ph 01342 322854, fax 01342 324574; **USA**—Adventures Unlimited, ph (815) 253 6390, fax (815) 253 6300.

This rare book on Pacific archaeology and anthropology is now back in print after more than 70 years. Written by John Macmillan Brown, an Oxford scholar, founding professor at the University of Canterbury in Christchurch, as well as prolific author and traveller, *The Riddle of the Pacific* is a classic text for its revelations about the roots of early 20th century culture in the Pacific and its evidence for a vast megalithic civilisation once having flourished in the region.

Macmillan Brown's story begins on Easter Island where he reports his findings about the people, their enigmatic sculpture, their

rituals, language and writing script, and speculates about their demise. Moving to the islands of Polynesia, Micronesia and New Zealand, he continues to document Pacific islander culture and draws fascinating connections among all these cultures, comparing their ancient stonework and road systems, their wartime and peacetime customs, their religions, languages and more. Further, he outlines similarities with cultures based on the Pacific coast of South America. The photographs, illustrations and maps are very special for their historical significance.

Did these Pacific cultures spread because of the islanders' seafaring skills or were their cultures once part of a vast lost continent whose megalithic remnants still defy explanation in modern times? Macmillan Brown's thesis seems to support both.

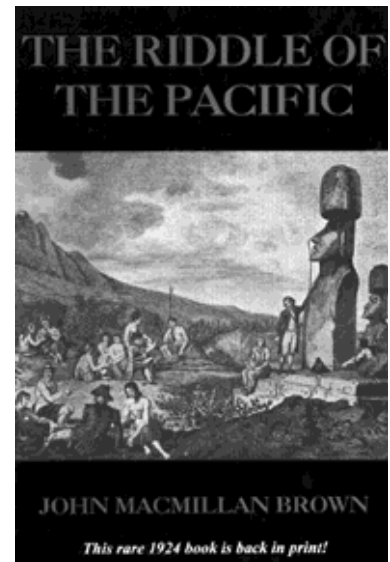

REVIEWS



BOOKS

WHO'S WHO OF THE ELITE

by Robert Gaylon Ross, Sr

Published by Ross International Enterprises (1995), San Marcos, TX, USA ISBN 0-9649888-0-1 (277pp l/f s/c)

Price: AUD\$52.00 in Aust; USD\$25.95 + p&h in USA/Canada; USD\$32.90

Aust/NZ airmail; USD\$30.90 UK/Europe airmail

Available: **Aust**—Cameron Books, ph/fax (074) 58 7676; **USA**—RIE, 1700-A R.R. 12, #325, San Marcos, TX 78666-2502, ph/fax (512) 396 7000, 1-800 410 5571.

If a global 'elite' is indeed hellbent on controlling the world, and it's names that you want, then this is the book that names names. *Who's Who of the Elite* is primarily a book of lists: plenty of characters but, as far as plot is concerned, you'll have to read between the lines, consult the wealth of references in the conspiracy literature, or wait for the release of the author's follow-up book, *They Don't Dare Let Us Tell The People*.

The 'elite' featured in this volume are members of the Council on Foreign Relations and the Trilateral Commission, as well as the much more secretive Bilderberg group (whose 1995 listing was supplied by the *Spotlight* newspaper). Not as current, but still useful is the author's reprint of Antony Sutton's 1986 Yale Skull & Bones list.

Author Robert Gaylon Ross, Sr, doesn't profess to have all the 'day job' details pertaining to each member but he welcomes

input from readers so he may better update these lists in due course. He lists names alphabetically, and also according to affiliation, whether in government, administration, the judiciary, law, finance, industry, education, the media, unions, foreign nation, etc. What's also interesting are his summaries of membership distribution among these elite networks, plus charts which cross-reference banking families and other NWO elitists.

Having all these lists together in the one book is certainly a boon for conspiracy researchers and armchair media-watchers. Keep it handy when you're watching TV!

CONTACTS WITH THE GODS FROM SPACE: Pathway to the New Millennium

by George King, with Richard Lawrence

Published by The Aetherius Society (1996), CA, USA

ISBN 0-937249-15-7 (160pp s/c)

Price: AUD\$32.00; NZD\$32.00;

STG£9.95; USD\$14.95 + p&h;

Available: **Aust**—The Aetherius Society,

ph (02) 9949 6038; **NZ**—A/S, ph (09)

444 4065; **UK**—A/S, ph 0171 736 4187,

fax 0171 731 1067; **USA**—A/S, ph (213)

465 9652, fax (213) 462 5165.

So much information has come out in recent years about contacts with ETs, yet little is sufficiently encompassing to satisfy our thirst for the whole truth. Why should our attention be diverted towards entities who desire to be masters of the physical universe? Surely there has to be more—much more.

One individual who appreciates the vastness of our possibilities is Sir George King, DD, ThD, a yogic master who, for over 40 years has been in communication with extraterrestrial intelligences existing on higher vibrational planes within our solar system.

In 1954, on the instruction of a member of the Great White Brotherhood, Sir George founded The Aetherius Society for the purpose of bringing enlightenment to mankind through service. He channels a selection of Cosmic Masters who have given him hundreds of teachings for dissemination through the Society. He has even been required to transfer cosmic energy to power centres across the planet.

The teachings explained in *Contacts with the Gods from Space* answer many questions about humanity's origins, the role of ETs in our development and why UFOs are so active now, but they also advocate the principle of spiritual ecology to assist us in creating a positive future where the opportunity for communication beyond the physical dimensions becomes possible and, indeed, is our true birthright.

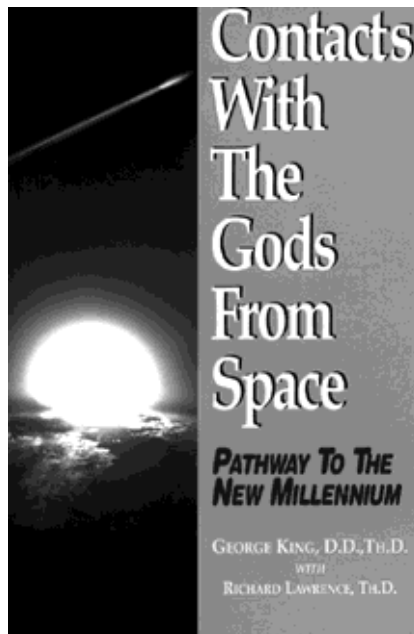



REVIEWS

EMERGING VIRUSES: AIDS & Ebola—Nature, Accident or Intentional?

by Leonard G. Horowitz, D.M.D., M.A.

Published by Tetrahedron Publishing Group (1996), Rockport, MA, USA
ISBN 0-923550-12-7 (590pp h/c)
Price: AUD\$60.00; USD\$29.95 + \$4.50 p&h; CAN\$36.00 + \$8.00 p&h
Available: **Aust**—Cameron Books, ph/fax (047) 58 7676; **USA**—Tetrahedron Publishing Group, 20 Drumlin Rd, Rockport, MA 01966, ph (508) 546 6586, 1-800 336 9266, fax (508) 546 9226.

This is the most comprehensive exploration yet of the origin of the world's most feared and deadly viruses—AIDS and Ebola. Written by Harvard graduate and independent scientific/medical researcher Dr Leonard Horowitz, *Emerging Viruses* is an in-depth study into whether these viruses were accidentally or deliberately created and released—as opposed to being 'naturally' spread by African green monkeys.

Dr Horowitz delves into the Cold War climate that fostered the biological warfare programs of the military-industrial-pharmaceutical complex to create rogue immune-system-ravaging pathogens and other scourges as part of a New World Order agenda.

It is Dr Horowitz's conclusion that AIDS most likely evolved from early cancer virus vaccine experiments where military scientists (Fort Detrick) co-opted with pharmaceutical companies (Litton Bionetics, Merck, Sharp and Dohme, Hazelton Research) to infect monkeys with viral genes from other animals to produce an array of illnesses for the National Cancer Institute's human cancer vaccine trials. He cites convincing evidence for AIDS having emerged in labs as a result of sample contamination, finding its way into experimental hepatitis, polio and smallpox vaccines used in trials in the US and Africa during the 1970s. The dreaded haemorrhagic fever viruses Ebola and Marburg may well have emerged in similar fashion.

This is a controversial and exhaustively referenced account that exposes a number of well-known public figures for their part in implementing a global conspiracy.

SMUGGLED-2: Wildlife Trafficking, Crime and Corruption in Australia by Raymond Hoser

Published by Kotabi Pty Ltd (1996), Victoria, Australia
ISBN 0-9586769-0-9 (279pp s/c)
Price: AUD\$24.95 inc. p&h in Aust.; overseas orders, add AUD\$5.00 airmail
Available: **Australia**—Kotabi Pty Ltd, PO Box 599, Doncaster, Vic. 3108, ph +61 (0)3 9857 4491, fax +61 (0)3 9857 4664.

Raymond Hoser is an author and internationally regarded authority on Australian reptiles. Ironically, some of these 'reptiles' hold down desk jobs with various government departments! Hoser knows all too well the tactics that corrupt bureaucrats employ in sanctioning illegal trafficking in rare fauna, and the lengths to which they will go to gag a lone voice in the wilderness for the sake of immense profit.

The prequel to this book, *Smuggled: The Underground Trade in Australia's Wildlife*, was banned for a time due to pressure applied by the New South Wales National Parks & Wildlife Service. Even before the release of *Smuggled-2*, Hoser learnt that two national book distributors as well as print and electronic media have already been 'leaned on' in an attempt to stop his latest revelations getting out to the public at large.

Smuggled-2 is a savage reminder that high-level corruption, costing taxpayers millions of dollars, continues to rise unchecked when it's supported by a web of criminal activity extending into illegal drug-trafficking and arms dealing. At great personal risk, Hoser has 'dug up the dirt' on wildlife smuggling at both national and international levels. He names names and supports his claims with documentary and photographic evidence. When arson, bashings, bribery, court-fixing, forgery, murders, phone-tapping, theft and victimisation are the order of the day, corruption is well out of control. Sadly, "wildlife" has taken on a whole new meaning.

CONSPIRACIES, COVER-UPS & CRIMES

by Jonathan Vankin

Published by IllumiNet Press (1996), Lilburn, GA, USA
ISBN 1-881532-09-7 (412pp s/c)
Price: AUD\$27.00; NZD\$38.00 + p&h; STG£12.95; USD\$16.95 + p&h
Available: **Aust**—NEXUS Magazine, ph (07) 5442 9280, fax (07) 5442 9381; **NZ**—NEXUS Office, ph (09) 416 7320, fax (09) 416 7340; **UK**—Counter Productions, PO Box 556, London SE5 ORL; **USA**—Adventures Unlimited, ph (815) 253 6390, fax (815) 253 6300.

If you missed out on Jonathan Vankin's 1992 classic, *Conspiracies, Cover-ups & Crimes*, now's your chance to add it to your collection with IllumiNet's just-released paperback edition with all-new introduction.

According to Vankin, the US conspiracy territory has changed considerably even in half a decade, and, thanks to the Internet and even *The X-Files*, it has crept closer to the mainstream—though mainstream media would still have us believe that conspiracy theorists are all paranoid right-wing extrem-

REVIEWS



BOOKS

ists (but that's another conspiracy!). Increasingly, 'normal' people are recognising that something is wrong—though they may not be sure exactly what. As Vankin demonstrates, just because a conspiracy theory may be 'paranoid', this doesn't mean it's not true!

In his 1992 edition, Vankin declared the '90s "The Conspiracy Decade". He wasn't wrong, for in the meantime—with events such as Waco, the mystery surrounding the death of Vince Foster and a multitude of others connected with Bill Clinton, the Oklahoma Bombing, UN tank-spotting across the US, and new JFK assassination revelations—conspiracy theories are looking more like out-and-out conspiracies.

Vankin's original text, written between 1988-1991, remains largely unchanged in this edition. His commentaries, on everything from Votescam, Larouche, UFOs, JFK, CIA and the drug war, secret societies and the world government, are essential background reading, even if you never thought you were interested in conspiracy politics.

GODS OF THE NEW MILLENNIUM: Scientific Proof of Flesh & Blood Gods by Alan F. Alford

Published by Eridu Books (1996), UK
ISBN 0-9527994-0-5 (479pp h/c)
Price: AUD\$62.50; NZD\$72.00;
STG£27.60; USD\$46.00 (prices inc. p&h)
Available: **UK**—Eridu Books, PO Box 107, Walsall WS9 9YR, England, ph +44 (0)1543 452577, fax +44 (0)1543 452578, web: <http://www.eridu.co.uk>

This book is the result of author Alan Alford's 10-year quest to document the intervention of flesh-and-blood gods in humanity's development—and herald their possible imminent return. With the sudden emergence of *Homo sapiens* 200,000 years ago defying all the principles of evolutionary theory, and the biblical creation account being at odds with the laws of physics, the fact that we *are* here rather defies explanation.

To gather material for *Gods of the New Millennium*, Alford has travelled to ancient sites around the globe to determine for himself their commonalities. He has also embarked on an extensive critique of Zecharia Sitchin's studies of Sumeria as the 'first civilisation' (though we might well dispute this assumption), but he has revised his chronology through the discovery of a simple mathematical key. As a result, Alford claims to be able to match the creation of mankind with the most recent scientific estimates and reconcile the arrival of the gods

and mankind's creation with the independently verifiable date of the Great Flood.

Alford has also developed a new theory on the importance of the 25,920-year precessional cycle and reasons that Machu Picchu and Stonehenge were both sites connected to the change from the era of Taurus to Aries over 4,000 years ago.

This book contains many controversial claims which challenge scientific orthodoxy, but it is well worth studying because it expands the boundaries of the knowable.

RUMORS OF EXISTENCE

by Matthew A. Bille

Published by Hancock House (1995),
Canada and USA

ISBN 0-88839-335-0 (192pp s/c)

Price: AUD\$26.00; NZD\$29.95 + p&h;
STG£9.99; USD\$12.95 + p&h

Available: **Aust**—Cameron Books, ph/fax (047) 58 7676; **NZ**—NEXUS Office, ph (09) 416 7320, fax (09) 416 7340; **UK**—Gazelle Book Services, ph 01524 68765; **USA**—Adventures Unlimited, ph (815) 253 6390, fax (815) 253 6300.

Subtitled "Newly Discovered, Supposedly Extinct, and Unconfirmed Inhabitants of the Animal Kingdom", *Rumors of Existence* documents, albeit briefly, the vast gaps in our knowledge about the animal world.

Despite valid concerns about our planet's dwindling biodiversity, it's amazing to learn that since 1940 an average of three new birds and more than three new mammal species have been described each year. For instance, in 1992 in Vietnam near the Laotian border, an international scientific team discovered a large mammal, the Vu Quang oryx. But, as is often the case, the indigenous people are already aware of these unclassified creatures but just haven't told the outside world!

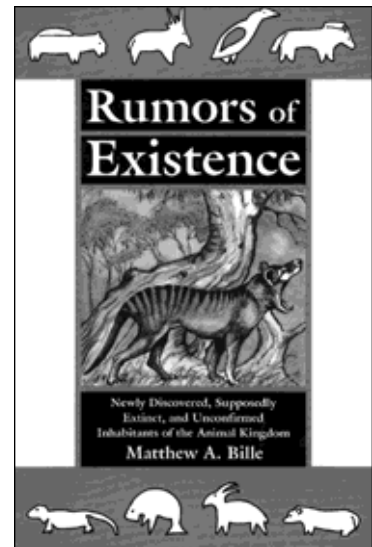



REVIEWS

Author Matthew Bille highlights two dozen of these new global discoveries, but adds to his catalogue with an equally lengthy rundown of animals presumed extinct, but for which evidence for their continued existence often resurfaces. These 'lost' animals include the Tasmanian tiger, the aye-aye lemur of Madagascar and the Sinai leopard. Finally, Bille describes some of the mystery animals that are the stuff of legend or at least very rare sightings, e.g., a giant gecko, a dolphin with two dorsal fins, and a giant octopus. One day, these and many more elusive creatures may be described by zoologists.

This book may not be big on illustrations for obvious reasons, but Bille has included an extensive reference list to please the most ardent cryptozoology freak.

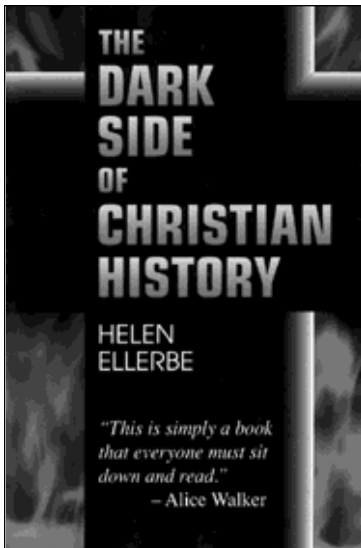

THE DARK SIDE OF CHRISTIAN HISTORY

by Helen Ellerbe

Published by Morningstar Books (1995), San Rafael, CA, USA

ISBN 0-9644873-4-9 (228pp s/c)

Price: AUD\$26.00; USD\$12.95

Available: **Aust**—Cameron Books, ph/fax (047) 58 7676; Sydney Esoteric Bookshop, ph (02) 9212 2225; **USA**—Morningstar Books, PO Box 4032, San Rafael, CA 94913, ph (415) 472 6000.

While admittedly not a complete picture of the history of the Christian Church, Helen Ellerbe's book is a succinct account of the dark legacy that permeates Western society and has fostered (as it still does) sexism, racism, fear, war, competition, domination and environmental degradation for the last two millennia. By shedding light on this dark history, Ellerbe aims to show how the Church has controlled the individual's direct spiritual connection to the divine and has

robbed humanity of freedom and dignity.

The episodes she covers include the early political manoeuvrings of the Church in Rome; the irrational decisions made on dogma in the early centuries AD; the plunge into the Dark Ages where education, science, technology, medicine, history, art and commerce were effectively wiped out; the Crusades and pogroms of the Middle Ages; the Inquisition; Catholic vs Protestant faction-fighting of the Reformation and Counter Reformation; witch-burnings; the alienation of nature in the so-called Age of Enlightenment; and the enforcement of a limited scientific paradigm upon human thought and creativity in the ensuing period.

The author contends that by ignoring the 'dark side' of Christian history and not examining the belief systems and ideologies which have promoted cruelty through the centuries, we perpetuate the idea that man has an inherently evil nature. Consequently, destructive patterns continue to alienate people from God, Nature and each other.

YOU CAN HAVE YOUR PERMACULTURE AND EAT IT TOO

by Robin Clayfield

Published by Earthcare Education (1996), Queensland, Australia

ISBN 0-646-28784-2 (257pp l/f s/c)

Price: AUD\$38.00 inc. p&h in Aust;

overseas orders phone for p&h quote

Available: **Australia**—Earthcare Education, 58 Crystal Waters, MS16, Maleny, Qld 4552, ph +61 (0)7 5494 4707.

This is an inspiring, self-help manual for gardeners who like to cook, and cooks who like to garden. Author/teacher Robin Clayfield has an holistic, hands-on approach to promoting permaculture principles and self-sufficiency techniques for a healthier, more fulfilling, sustainable lifestyle.

Step by step, Robin covers all the essential elements of permaculture design, preparing, planting, harvesting and seed-saving for all manner of foods—grains, vegetables, fruit orchards, herbs—and even includes small animal husbandry in the scheme. In this total approach, important considerations such as biodiversity, biodynamics, energy efficiency, irrigation, mulching, natural pest control, seasonality, and more, are well covered.

Robin's experience in teaching courses in permaculture design, gardening and cooking holds her in good stead here, for (with a little help from her Crystal Waters friends) she presents the information with easy-to-understand charts, diagrams and illustrations. She also includes contributions from colleagues specialising in the permaculture field.

So, the reward for producing all this

REVIEWS



BOOKS

delightful, energetic food is to eat it—lovingly and joyfully! Robin comprehensively covers everything from menu planning, budgeting, selecting cooking tools, to preparing bush food and making preserves. She includes a vast array of tempting recipes with loads of practical advice. Robin's hands-in-the-earth enthusiasm will encourage even the non-cooks and non-gardeners out there!

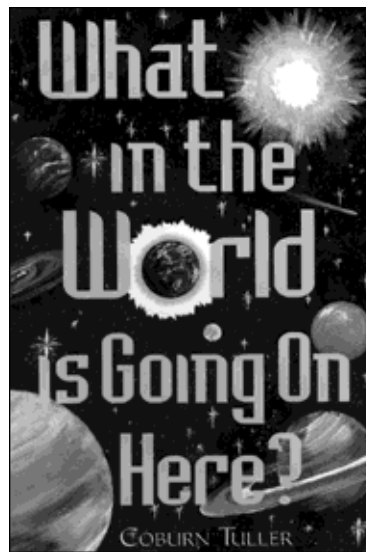

WHAT IN THE WORLD IS GOING ON HERE?

by Coburn Tuller

Published by Butterfly (1995), MO, USA
ISBN 1-886322-17-1 (331pp s/c)
Price: AUD\$35.00; NZD\$39.95 + p&h;
USD\$17.50 + p&h; CAN\$25.00 + p&h
Available: **Aust**—Cameron Books, ph/fax
(047) 58 7676; **NZ**—NEXUS Office, ph
(09) 416 7320, fax (09) 416 7340; **USA**—
Adventures Unlimited, ph (815) 253
6390, fax (815) 253 6300.

Yes, there is a light at the end of the tunnel, but it's not necessarily a train coming! Seriously, this is a book about the journey of a lifetime—the search to find the Source of Light and Love within. Author Coburn Tuller embarked on his quest to find his nebulous destination when he knew he needed to change, knew he was yet to 'arrive', though he had no idea of the vastness of the territory he had yet to discover.

He has written *What in the World is Going on Here?* as a guidebook for fellow travellers who have lost their bearings. If you feel the need to embark upon a journey of self-discovery and spiritual transformation but are still waiting for your train to come in or don't even know where to get on, then

this book is guaranteed to give you the push-start you're looking for.

But first things first: get rid of that excess baggage! As Tuller found out, it's impossible to tune into that true lightness of being when we're weighed down with mental constructs and emotional chains which hinder expansion into the intuitive realms and prevent progress on the spiritual path. Even seasoned travellers may suddenly find themselves back on the right track, for Tuller reminds us that love and wisdom is within reach of anyone who seeks it. And we can bring our sense of humour along for the ride!

"Q" MECHANICS

by Terry J. Skrinjar & Steven T. Walker

Published by T. J. Skrinjar & S. T. Walker
(1996), Queensland, Australia

ISBN 0-646-29325-7 (110pp s/c)

Price: AUD\$35.00 + AUD\$4.50 p&h in
Aust; NZ airmail add AUD\$7.50; airmail
elsewhere, add AUD\$12.50

Available: **Australia**—JKA Distributors,
PO Box 2203, Toowoomba, Qld 4350,
ph +61 (0)76 34 5952.

Barely a week passes without NEXUS receiving a new theory about life, the universe and everything. Each one represents a painstaking, praiseworthy and often lifelong effort on the part of the theorist, but few are presented in a way that makes them easily readable, let alone understandable, so few manage to get published despite the fact that their authors may well be onto something.

In this instance, authors Terry Skrinjar and Steve Walker have self-published their own theory in an easy-to-absorb format supported by clear diagrams. They claim that "Q" Mechanics can explain not only the creation of energy but creation itself—in its entirety! This is a big claim, but, for the assumptions they overturn in their rationale, their theory is well worthy of analysis.

The authors point out the pitfalls in the mathematical and physical constructs we use to define reality (but they sure don't waste space on equations). They define energy as an effect of an effect. They throw out the old atomic model and throw over an advanced matrix field concept to redefine theories of space, electricity, gravity, inertia and magnetism. The resonance of an object is that object. This does make sense, but it has a familiar ring to it as if this has already been defined in 'frontier science' territory.

But, new science dabblers, don't despair: this slim tome contains specifications (and warnings) on how to build a device to create "Q energy". Could this be the holy grail of free energy? You be the judge!



REVIEWS

AUDIO

Reviewed by Richard Giles

THE MUSIC OF THE GRAND CANYON

by Nicholas Gunn

Produced by Nicholas Gunn for Real Music (1995), Sausalito, CA, USA
Catalogue no. RM1422 (53mins)
Price: AUD\$18.95, USD\$10.00 (cass.);
AUD\$28.95, USD\$16.00 (CD)
Available: **Australia**—New World
Productions, ph (07) 3367 0788; **USA**—
Real Music, ph (415) 3311 8275.

The keyboard master is back again with a third album. His previous two, *Afternoon in Sedona*, and *The Sacred Fire*, were very successful and among my favourites of the year when released. To capture the feel of the Grand Canyon is some grand feat, and Nicholas Gunn has done it! When I first visited the place, there were simply no words to express the stunning experience of the Canyon's vastness, and I feel that same power on Gunn's album. Three particularly special tracks are "Entering Twin Falls", "Flight Over North Rim", and the title track, "Grand Canyon". Well recommended.

AFRO-DESIA

by Steven Halpern & Suru

Produced by Steven Halpern for Inner Peace Music (1996), USA
Cat. no. SRXD 9004 (69mins)
Price: AUD\$19.95, USD\$9.98 (cass.);
AUD\$29.95, USD\$14.98 (CD)
Available: **Aust**—MRA Entertainment, ph
(07) 3849 6020; **USA**—Inner Peace
Music, ph (415) 485 5321, 1-800 909
0707.

Steve Halpern is widely known for his relaxation/ambient music, with a career spanning 20 years. Deciding to take a shift to some high-energy music and return to his roots in rhythm/soul, he recorded an album with Suru Ekeh, the (late) master Nigerian drummer. It's great to hear Halpern move with a combination of percussion and West African/jazz. The most exciting track, "Afro-Desia", is first up, followed by wonderful drum/rhythm pieces, some louder and others more gentle. Joyful drumming.

OLE, OLE

by Rachid Taha

Produced by Steve Hillage for FKO Music (1995), France
Cat. no. CD529.481-2 (56mins)
Price: AUD\$19.95 (cass.), AUD\$29.95
(CD)
Available: **Aust**—Island/Mango Records,
ph (02) 9207 0500; **Europe**—FKO Music,
France, ph +33 1 43 70 55 27;
Metronome, Germany.

Here's an album that takes some classifying. Rachid does not want his work to be known as world music, but at the same time his arrangements and sounds seem to be sampled from all over the French, Iberian and Arab-Mediterranean regions. Songs like the sunny "Valencia" mix with the luted "Baadini", the aggressive "Boire", hip-hop "Zaâma", tongue-in-cheek "Tabla Motown" and the techno "Non Non Non". It's wonderfully innovative material. Great dance music with some incisive social comment. Well recommended.

THE HALF TAIL

by Wolfstone

Produced by Chris Harley for Green Linnet Records (1996), Danbury, USA
Cat. no. GLCD 1172 (43mins)
Price: AUD\$19.95, USD\$8.50 (cass.);
AUD\$29.95, USD\$15.00 (CD)
Available: **Aust**—Movieplay Australia,
ph (02) 9905 0199, fax (02) 9905 6372;
USA—Green Linnet Records, ph 1-800
468 6644, fax (203) 778 4443.

These guys mix wild Celtic reels and jigs with a rocky band beat. Songs range through the sentimental quiet soul of Celtic to the swinging pipes and whistles of vigorous Irish/Scottish flings. All the music was recorded in Scotland but released by Green Linnet, a US record company devoted to promoting the best of traditional Celtic music. Put this album on when you feel like lifting your feet, having a good time, and swaying to the sweet sounds of the Celts.

MICKEY HART'S MYSTERY BOX

Produced by Mickey Hart for Rykodisc (1996), Salem, MA, USA
Cat. no. CD31597 (54mins)
Price: AUD\$19.95, USD\$9.00 (cass.);
AUD\$29.95, USD\$15.00 (CD)
Available: **Aust**—Festival Records, ph
(02) 9660 4022; **USA**—Rykodisc, ph
(508) 744 7678.

Mickey Hart (ex-Grateful Dead) is one of the greats of drum music, as well as author of *Drumming at the Edge of Magic* and *Planet Drum*. He's assembled a fine bunch of musicians with Zakir Hussain on percussion, Habib Faye on guitar, Jeff Stirling on keyboards, and English vocal group The Mint Juleps. Here, he's tried something completely different from previous productions (*Planet Drum*, the album, won a musical Grammy in 1991). Hot vocals and instrumental boppy dance music are mixed with world rhythms. Not everything on the album makes it, but there are still some superb tracks on his *Mystery Box*. Recommended.

Endnotes

- ¹(a) Small, Marie-Louise, "Psi Spies", *Encounters*, no. 7, May 1996;
 (b) Ostrander, Sheila and Lynn Schroeder, *Psychic Discoveries Behind the Iron Curtain*, Prentice-Hall, USA, 1970.
² *New Scientist*, 23/30 December 1995.
³ Future Fantastic, BBC-1 telecast, 9 August 1996.
⁴ Dennett, Daniel C., *Darwin's Dangerous Idea*, Simon & Schuster, 1995.
⁵(a) Chomsky, Noam, *Three Models for the Description of Language*, 1956; *Syntactic Structures*, 1957; "Review of Skinner", *Language*, vol. 35, 1957; *Cartesian Linguistics*, 1966; *Language and Mind*, 1972; *Reflections on Language*, 1975; "Rules and Representations", *Behavioural and Brain Sciences*, vol. 3; "Language and Problems of Knowledge", The Managua Lectures, 1988;
 (b) Cohen, Philip, "Signs Point to the Language Instinct", *New Scientist*, no. 2017, 17 February 1996.
⁶ Edelman, Gerald, *Neural Darwinism*, 1987.
⁷ Refer to entire work of Rupert Sheldrake.
⁸ Dennett, p. 176.
⁹ Cohen, J. B., *Revolution in Science*. According to Cohen, Lichtenberg developed the notion of paradigms as "frameworks for thought" and identified the contextual nature of belief that Marx and Engels were to exploit. Lichtenberg went chasing after the primitive (atomic) elements of scientific knowledge that could be considered the analog of the grammatical standards which make language work and which would explain the extragenetic nature of the intents behind seminal language.
¹⁰(a) Koestler, Arthur, *The Ghost in the Machine*, 1967;
 (b) Popper and Eccles, *The Self and the Brain*, 1977;

Res Cogitans, 1972;

- (b) Vendler, Zeno, *The Matter of Minds*, 1984.
¹¹ Eccles has proposed the idea that the non-physical mind is made up of millions of "psychons" which influence millions of "dendrons" (tracts of pyramidal cells) in the cortex. These psychons would be analogous to what Hume and Descartes would call an idea.
¹²(a) Sheldrake, Rupert, *The Presence of the Past*, 1988, pp. 220-222;
 (b) Stevenson, I., *Telepathic Impressions*, University of Virginia Press, Charlottesville, USA, 1970;
 (c) Palmer, S., "A Community Mail Survey of Psychic Experiences", *Journal of the American Society for Psychological Research* 73:221-251, 1979;
 (d) Wolman, B. B., *Handbook of Parapsychology*, Van Nostrand Reinhold, New York, 1977.
¹³ McMoneagle, Joseph, *Mind Trek*, 1993.
¹⁴(a) Jung, C. G., *The Archetypes of the Collective Unconscious*, Routledge & Kegan Paul, London, 1959;
 (b) Stevenson, I., *Twenty Cases Suggestive of Reincarnation*, University of Virginia Press, Charlottesville, USA, 1974.
¹⁵ Hamilton III, William, *Cosmic Top Secret: America's Secret UFO Program*, Inner Light Publications, 1991, p. 108. It is reported here that a worker, Thomas C., was employed at a top-secret underground base at Dulce, New Mexico, where the US military was working in conjunction with aliens. He claimed that on Level 4 of the base, "human aura research as well as all aspects of telepathy, hypnosis and dreams were studied". Thomas C. went on to say, "they know how to separate the bioplasmic body from the physical body and place an 'alien entity' life-force matrix within a human body after removing the 'soul' life-force matrix of the human".
¹⁶ Rickard, Bob, "From Russia with Anxiety", *Fortean Times*, no. 87, June 1996.
¹⁷ Edelman, Gerald, *Bright Air, Brilliant Fire*, Basic

Books, New York, 1992.

- ¹⁸ Kenworthy, Chris, "Lucid Dreams: Life Is But a Dream", *Encounters*, no. 11, September 1996.
¹⁹ Rifat, Turan, "Remote Viewing: the ESP of Espionage", *NEXUS*, vol. 3, no. 6, October-November 1996.
²⁰ For a brief discussion on remote sensing, see the author's web site: <http://www.fastnet.co.uk/pms>
²¹ Ostrander and Schroeder, *ibid*.
²² Small, *ibid*.
²³ In 1973 a Russian scientist named Dr Igor Vladsky sent a letter to Harvard psychologist Gene Kearney, in which he leaked information about the Leningrad psychical research facility and its telekinesis experiments. The story of how researchers set off for Russia to find this base is retold in Bob Rickard's "From Russia with Anxiety", in *Fortean Times*, no. 87, June 1996.
²⁴(a) Lewis, David, *On the Plurality of Worlds*, Basil Blackwell Ltd, London, 1986;
 (b) Parsons, Kenneth, "The Multiverse", *Encounters*, vol. 10, August 1996.
²⁵ Jung, *ibid*.

About the Author:

Turan Rifat was born in Brighton in 1957. He has a university science degree and another in education. Whilst doing his Ph.D., the author decided he'd had enough of mechanistic science, so for the past 15 years he has been researching the paranormal.
 Recently he set up Paranormal Management Systems (PMS), the only company in Europe with expertise in biophysical RMCT. PMS evaluates this military-domain RMCT material and develops it in terms of its applications for business.
 Turan Rifat offers courses and consultancy in the RV/RI field and is currently writing a book, *Remote Viewing: The Story of the Real X-Files*.

Continued from page 28

Using one knee as a desk, I jotted notes with a pencil on two long envelopes that happened to be in my pocket...

The first thing I unearthed made me snort with disgust. It was a ponderous tome on the art of shipping four-legged animals. Was this the kind of twaddle American pilots were risking their lives to carry? But in the back I found a series of tables listing railroad mileages from almost any point in the United States to any other.

Neatly packed with the volume were scores of roadmaps, of the sort available at filling stations to all comers. But I made a note that they were "marked strangely". Taken together, they furnished a country-wide chart, with names and places, of American industrial plants. For example, Pittsburgh entries included "Westinghouse" and "Blaw-Knox".

The next suitcase to be opened was crammed with material assembled in America by the official Soviet news organ, the Tass Telegraph Agency. A third was devoted to Russia's government-owned Amtorg Trading Corporation of New York. One yielded a collection of maps of the

Panama Canal Commission, with the markings to show strategic spots in the Canal Zone and distances to islands and ports within a 1,000-mile radius.

Another was filled with documents relating to the Aberdeen Proving Ground, one of the most "sensitive" areas in the war effort. Judging by their contents, various suitcases could have been labeled under the heads of machine tools, oil refineries, blast furnaces, steel foundries, mining, coal, concrete, and the like. Other folders were stuffed with naval and shipping intelligence. There seemed to be hundreds of commercial catalogues and scientific magazines... There were also sheafs of info about Mexico, Argentina and Cuba.

There were groups of documents which, on the evidence of stationery, had been contributed by the Departments of Agriculture, Commerce and State. All such papers had been trimmed close to the text, with white margins removed. I decided that this was done either to save weight, or to remove "Secret", "Confidential" or "Restricted" stamps that might have halted a shipment, or for both reasons...

Then I copied the legend: "From Hiss". I had never heard of Alger Hiss, and made

the entry because the folder bearing his name happened to be second in the pile. It contained hundreds of photostats of what seemed to be military reports...

A suitcase opened midway in the search appeared to contain nothing but engineering and scientific treatises. They bristled with formulae, calculations and professional jargon. I was about to close the case and pass on when my eye was caught by a specimen of stationery such as I had never before seen.

Its letterhead was a magic incantation: "The White House, Washington". As prospective owner of an 80-acre tract along the shore of Washington State, I was impressed by the lordly omission of the capitals, "D.C.". Under the flashlight I studied this paper with attention. It was a brief note, of two sheets, in a script which was not level but sloped upward to the right. The name to which it was addressed, "Mikoyan", was wholly new to me. (By questioning Colonel Kotikov later, I learned that A. I. Mikoyan at the moment was Russia's No. 3 man, after Premier Stalin and Foreign Commissar Molotov. He was Commissar of Foreign Trade and Soviet boss of Lend-Lease.)

— The Explosive Secrets of Major Jordan's Diaries —

A salutation, "My dear Mr Minister", led to a few sentences of stock courtesies. One passage, of eleven words, in the top line of the second page, impressed me enough to merit a scribble on my envelope. That excerpt ran thus: "_____ had a hell of a time getting these away from Groves."

The last two words should not be taken as referring to Major General Leslie R. Groves himself. What they meant, probably, was "from the Groves organization". The commander of the Manhattan Engineer District, later the Manhattan Project, was almost unique in the Washington hierarchy for his dislike and suspicion of Russia...

The first thing I had done, on finding the White House note, was to flip over the page to look for a signature. I penciled it on my envelope as "H. H." This may not have been an exact transcription. In any case, my intention is clear. It was to chronicle, on the spot, my identification of the author as Harry Hopkins. It was general usage at Great Falls and elsewhere to refer to him as "Harry Hopkins", without the middle initial.

I remember distinctly having had to remove that letter from a metal clip. It held two other exhibits—obviously the things

which [someone] had such difficulty in "getting away from Groves". One was a thick map. When unfolded, it proved to be as wide as the span of my extended arms. In large letters it bore a legend which I recorded: "Oak Ridge, Manhattan Engineering District".

The other was a carbon copy of a report, two or three pages long, which was dated Oak Ridge. If it had a signature, I did not set it down. At the top of the first page, impressed with a rubber stamp, or typed, was the legend: "Harry Hopkins" followed by the title "Special Asst. Co-ordinator" or "Administrator". I gathered that this particular copy had been earmarked for Mr Hopkins. In the text of the report was encountered a series of vocables so outlandish that I made a memo to look up their meaning. Among them were "cyclotron", "proton" and "deuteron". There were curious phrases like "energy produced by fission" and "walls five feet thick, of lead and water, to control flying neutrons".

Probably no more than 200 men in all the country would have been capable at the time of noting down these particular expressions out of their own heads. The paper on which I made my notes was later

submitted to the Bureau of Standards for a test of its age.

For the first time in my life, I met the word "uranium". The exact phrase was "Uranium 92". From a book of reference I learned afterward that uranium is the 92nd element in atomic weight.

At the time of this episode I was as unaware as anyone could be of Oak Ridge, the Manhattan District and its chief, General Groves. The enterprise has been celebrated as "the best guarded secret in history". It was superlatively hush-hush, to the extreme that Army officers in the "know" were forbidden to mention it over their private telephones inside the Pentagon. General Groves has testified that his office would have refused to send any documents to the White House, without authority from himself, even if it was requested personally by the President...

Continued in the next issue of NEXUS...

**Copies of *From Major Jordan's Diaries* are available from NEXUS. Contact your local office for prices. In Australia, send \$40.00 (includes p&h) to:
NEXUS, PO Box 30, Mapleton Qld 4560**

Continued from page 60

once that she had not thrown it. And each time the needle on the magnetometer did indeed deflect, though Eduardo thought this might have been caused by creaking bedsprings.⁵

It is difficult to understand how bedsprings could cause power surges strong enough to register on a magnetometer (I, myself, have used many types of these instruments during investigations), and even more difficult to understand how they could induce deflections which happened to coincide with the movements of objects. Also, it's a wonder the investigators did not eliminate this as an option, if they thought it was possible, by simply moving the instrument away from the bedsprings. Magnetometers are of course designed to withstand the effects of magnetic fields, and so it is even more puzzling why the following reasoning and actions were employed:

"I was a little worried that he might have to go back to his university and report that the expensive instrument he had borrowed without permission had broken down, so we called off the experiment once we were

satisfied that it seemed possible that there was some link between poltergeist activity and anomalous behaviour of the surrounding magnetic field."⁶

One of the primary investigators of the Green Street 'poltergeist' in Enfield, North London, was Maurice Grosse, who has given many lectures on his experiences and is now regarded as one of the leading authorities on this kind of phenomenon. On the whole, 'poltergeists' are regarded as discarnate and mischievous entities who home in on the energies of an adolescent focus and who unintentionally wreak havoc wherever they go, although particular locations are usually favoured for the most spectacular phenomena.

In the course of my career as an investigator, I have discovered that 'poltergeist' activity takes place in electromagnetic hotspots, and is electromagnetic in nature. However, 'poltergeist expert' Maurice Grosse takes a different view:

"Albert's enthusiasm for his suppositions does him credit, but...displays a distinct lack of practical experience of psychic phenomena... I look forward with great interest to the day when flying boxes, stones, toys, heavy items of furniture, plus sponta-

neous fires and water phenomena, together with the passage of matter through matter, levitation, metal bending, to name just a few examples of poltergeist high jinks I have personally experienced, can be explained by electromagnetic and bioelectromagnetic activity."⁷

Well, Maurice, this is the day you have been waiting for! In fact, it was "the day" over 15 years ago when Guy Lyon Playfair's book on the Enfield 'poltergeist' was published in 1981 in the UK, when at the same time on the other side of the world in British Columbia, Canada, John Hutchison's device was just getting underway and generating all of the physical 'poltergeist' activity you were considering.

ELECTROMAGNETIC HYPERSENSITIVITY

This is not the place to fully expound my own biological research into how the human body reacts to prolonged field exposure, except to say that the body eventually acts as an oscillator and can add to the electromagnetic mayhem generated at hotspots. That is to say, I would add to the Hutchison Effect by including my own findings, as outlined in my books, which

point to 'poltergeists' being electromagnetic phenomena, and my conclusion that there is a bioelectromagnetic aspect where the human body behaves as another piece of electrical apparatus or hardware and re-radiates generalised ambient fields in more beam-like, coherent forms. This is a symptom of an increasingly common clinical condition known as electromagnetic hypersensitivity (EH), caused by exposure to electromagnetic pollution from power lines, transmitters, etc. The condition was the subject for an international conference of medical specialists and academics at Graz, Austria, in 1994. It is treated at the Breakspear Hospital in Hertfordshire, England.

However, nobody in psychical research here in England seems to be aware of EH or the work of John Hutchison, and there are fixed ideas which are protected with a religious fervour. Freak electromagnetic field conditions which seem to stretch the laws of physics to almost breaking point are not a welcome conclusion, although the history of science is littered with painful upheavals where the established view is turned on its head, and iconoclasts like myself and, unwittingly, John Hutchison,

threaten the status quo. For example, Dr John Beloff, the Editor of *Anomaly*, the respected journal of the Society of Psychical Research, wrote to me to tell me:

"Whatever the relevance of exposure to EM radiation...it has no obvious bearing on psychic experiences in general."

Having investigated reports of apparitions and 'poltergeists' in hot-spot locations for over three years, and measured the fields present with my trusty field meter, this statement made no sense at all. Perhaps the reader will have some inkling of the sort of establishment opposition I am up against, or may even refuse to believe the Hutchison Effect themselves.

However, it must be remembered that a number of well-known electrical engineering organisations have been involved. For example, McDonnell-Douglas Aerospace and the Max Planck Institute in Germany, both took many photographs, some of which appear here.

I anticipate that there will be a wave of controversy as a result of this article, if the reactions here in the UK are anything to go by, and I would be interested in any constructive suggestions that readers may have.

Endnotes

¹ Burke, Harry E., *Handbook of Magnetic Phenomena*, Van Nostrand Reinhold Company, NY, 1986.

² Playfair, Guy Lyon, *This House Is Haunted*, Sphere Books, UK, 1981, p. 113.

³ *ibid.*, p. 62.

⁴ *ibid.*, p. 45.

⁵ *ibid.*, pp. 77-78.

⁶ *ibid.*

⁷ *Anomaly*, Journal of the Association for the Scientific Study of Anomalous Phenomena, UK, vol. 17, November 1995.

About the Author:

Albert Budden, B.Ed., is an investigator specialising in the scientific study of the paranormal as well as electromagnetics and health. He is the author of several books, including *Allergies and Aliens: The Visitation Experience—An Environmental Health Issue* (Discovery Times Press, 1994), *UFOs: Psychic Close Encounters—The Electromagnetic Indictment* (Blandford, 1995), and *The Poltergeist Machine: The Hutchison Effect—A Lift and Disruption System* (Discovery Times Press, 1996). He is a member of the Environmental Medicine Foundation.