

# CONTENTS

---

<b>WHO OWNS THE "FED".....5</b> <i>A revealing look at who 'owns' the U.S Federal Reserve</i>	<b>SUNLIGHT &amp; SKIN-CANCER.....19</b> <i>by Dr. Ronald S. Laura &amp; John F. Ashton. Too much artificial light and not enough natural sunlight - seem to cause more melanomas than we are told.</i>
<b>CROP CIRCLES.....7</b> <i>From Crop Circles to Hieroglyphs, the mystery continues</i>	<b>MIND MACHINES.....21</b> <i>by Peter Nielsen. A consumer guide to Mind Enhancement Technology, plus how to build your own "guerilla goggles"</i>
<b>FLUORIDATION.....9</b> <i>"Why I Changed my mind about Fluoride" by John Colquhoun BDS., PH.D A health official who checked for himself the dangers of fluoridation</i>	<b>UFO'S - ROSWELL REVISITED.....24</b> <i>Startling new claims by an eye witness, 43 years later may explain this mystery.</i>
<b>NEXUS NEWS.....10</b> <i>A round up of the news you probably did not see</i>	<b>BATTLE FOR YOUR MIND - Pt 4..26</b> <i>By Dick Sutphen. The final chapter in the continuing series dealing with the manipulation of your mind, looks at Television.</i>
<b>MOTHER SHIPTON'S PROPHECY.....13</b> <i>The most comprehensive collection of these rare 15th Century prophecies</i>	<b>TOWARDS BIG BROTHER.....28</b> <i>Medicare &amp; the next I.D Card Those fabulous Fabians Gulf War Media Censorship Police Confess on Drug War?</i>
<b>HERBS &amp; THEIR USES.....15</b> <i>Stinging Nettle - by Greg Ah Ket</i>	<b>THE TWILIGHT ZONE.....30</b> <i>A collection of strange and bizarre stories from around (and off) the world</i>
<b>CANCER CURE SUPPRESSED?.....16</b> <i>'The Persecution and Trial of Gaston Naessens', the true story of the efforts to suppress this treatment for Cancer, AIDS and other immune diseases.</i>	<b>REVIEWS - Books &amp; Tapes.....32</b>
<b>THE RISE OF THE KHAZARS.....17</b> <i>by Allan Cooke. Who were these mysterious people, and where are they now?</i>	

# NEXUS NEW TIMES

Volume 2, Number 3  
May-June 1991

**Editor  
& Advertising Mgr**  
Duncan M. Roads

**Assistant Editor**  
Catherine Simons

**CONTRIBUTORS**  
John Colquhoun Ph.D  
I.O. Heaps  
Allan Cooke  
Dick Sutphen  
Dr. Ronald S. Laura  
John F. Ashton  
Peter Nielsen  
Catherine Simons

## STATEMENT OF PURPOSE

Nexus Magazine recognises that humanity is undergoing a massive transformation. With this in mind, Nexus seeks to provide hard to get information so as to assist people through these changes.

Nexus is not linked to any religious, philosophical or political organisation.

## LAYOUT + DESIGN

Duncan Roads &  
MCF - 179 Glebe Pt Rd,  
Glebe NSW 2037  
Ph: 02 552 1133

## COVER GRAPHIC

Pete Turner,  
The Image Bank

## DISTRIBUTION BY

Newsagents Direct  
Distribution

# EDITORIAL

Welcome to another information packed edition of my favourite magazine - Nexus.

I would like to thank everyone who has and is contributing to the success of Nexus, including subscribers, advertisers and regular or casual buyers.

As you may have noticed from the inside front cover, the previous edition was an unparalleled success, both in terms of sales and response. I trust that you will not be disappointed with this issue either.

I would also like to thank the many people who take the time to clip articles from newspapers and magazines, and post them to me. It helps me keep an eye on the variety of news in many papers across Australia. (Special thanks to Rory, whoever you are.)

This edition opens with the remarkable phenomenon known as "crop circles". I am awaiting further information from the UK on this years' "harvest" so to speak. I hope you find the patterns as fascinating as I have.

Another article I found interesting is the one on the U.S. Federal Reserve being a privately owned company, this should make anybody who appreciates economics sit up and take note. I can pass on mail to the authors if needed, (they prefer to remain anonymous).

My favourite item this issue however - are the prophecies of Mother Shipton. I hope everyone takes the time to read these outstanding predictions, which are obviously coming true so far. I understand that this particular version of the prophecy has never been published before in the press. Can anyone tell me if this is actually the case?

Finally, I would like to remind readers that the aim of publishing such information, is not to alarm people, it is to inform people. I am disappointed that our news, especially in Australia is so lacking in accuracy and scope. I am, however, most happy to learn that there are those who place some priority on staying informed. It is my wish that Nexus contributes something of value to these seekers of truth.

Happy reading, and thanks for your support.

## NEXUS ADDRESS

C/ Post Office,  
MAPLETON, QLD.  
4560 Australia

Ph: 074 760 122

Fx: 074 760 122

## WARRANTY AND INDEMNITY

Advertisers upon and by lodging material with the Publisher for publication or authorising or approving of the publication of any material INDEMNIFY the Publisher and its servants and agents against all liability claims or proceedings whatsoever arising from the publication and without limiting the generality of the foregoing to indemnify each of them in relation to defamation, slander of title, breach of copyright, infringement of trademarks or names of publication titles, unfair competition or trade practices, royalties or violation of rights or privacy AND WARRANT that the material complies with all relevant laws and regulations and that its publication will not give rise to any rights against or liabilities in the Publisher, its servants or agents and in particular that nothing therein is capable of being misleading or deceptive or otherwise in breach of the Part V of the Trade Practices Act 1974. All expressions of opinion are published on the basis that they are not to be regarded as expressing the opinion of the Publisher or its servants or agents. Editorial advice is not specific and readers are advised to seek professional help for individual problems © Nexus New Times 1991

# WHO "OWNS" THE FEDERAL RESERVE?

*"We have in this country one of the most corrupt institutions the world has ever known. I refer to the Federal Reserve Board and the Federal Reserve Banks, hereinafter called the Fed..."*

*"They are not Government institutions. They are private monopolies which prey upon the people of the United States for the benefit of themselves and their foreign customers.."*

*"In that dark crew of financial pirates there are those who would cut a man's throat to get a dollar out of his pocket..."*

The Hon. Louis T. McFadden  
Chairman, (10years)  
Banking and Currency Committee

**The US Federal Reserve. It sounds like a typical bureaucratic institution. However this official sounding name is merely a 'front' to avoid public recognition, of the fact, that in essence it is a 'privately owned corporation'.**

**For those aware of the power of "The Fed" - this should be a chilling revelation indeed.**

# WHO "OWNS" THE FEDERAL RESERVE?

Q: What is the Federal Reserve Bank?

The Federal Reserve Bank is a Central Bank, or, the banker's Bank.

The United States is divided into 12 regions or districts, with each district having its own Federal Reserve Bank, eg The Federal Reserve Bank of Chicago, The Federal Reserve Bank of New York, etc etc.

The U.S. Government DOES NOT OWN ANY OF THE STOCK, OR PARTICIPATE IN THE PROFITS OF the Federal Reserve System. The Federal Reserve Banks are private stock corporations owned entirely by other private corporations known as member banks. They are no more 'Federal' than the Federal General Store in northern NSW!

A member bank of the Federal Reserve System is the local bank with which Americans do business directly.

The member banks are required to purchase stock in the Central Bank of its own district. This was, and probably still is, up to the extent of 6% of the amount of its capital stock outstanding. Each Member Bank must deposit on the books of the Federal Reserve Bank as high as 13% of their total demand deposits and 3% of their total time deposits.

These deposits which belong to the member banks are called their reserves.

All local banks must become members of the Federal Reserve System.

The average American who still walks around with cash in his pocket carries it in the form of Federal Reserve Notes. These are supplied to local (Member) banks by the Federal Reserve Bank.

The Federal Reserve Banks obtain Federal Reserve Notes by sending to the U.S. Treasury, Government Bonds to the face value of the number of \$5, \$10, etc bills desired. The US Treasury places the Government Bonds in sealed containers on which is labelled the name of the bank from which the bonds came. The bank then receives from the US Bureau of Engraving, Federal Reserve Notes (cash) to the full face value of the bonds sent to the US Treasury. While these notes are in circulation, the bank which pledged the bonds collects the interest coupons sent to the Treasury as collateral.

**The point to notice here, is that the banks obtain Government Bonds by basically making book-keeping entries!**

They then use these bonds to obtain Federal Reserve Notes (cash) from the Treasury. They even collect interest on the bonds deposited, but pay no interest on the currency received from the Treasury!

Federal Reserve Banks pay no taxes on any business transactions, even though they are private corporations. (Federal Reserve Act, Section 7, p.15)

The United States' President appoints the members of the Board of Governors of the 'Fed', the directors of the 12 regional Fed banks are not appointed by any political body.

There are 9 directors of each regional Federal Reserve Bank; 6 are appointed by local bankers and 3 by the Board of Governors of the Federal Reserve System.

But whoever controls the Federal Reserve Bank of New York holds all the aces.

Eustace Mullins, in his book, "The Secrets of the Federal Reserve" sheds a great deal of light on who 'owns' the controlling stock in this gigantic corporation. On page 179, he uncovers that as of July 26, 1983, the following banks owned 66% of the total out-standing shares of the Federal Reserve Bank of New York - the controlling district:

Bankers Trust	6%
Bank of New York	2%
Chase Manhattan Bank	14%
Chemical Bank	8%
Citibank	15%
European Amer.Bk.& Tr.	2%
J.Henry Schroder Bank	1/2%
Manufacturers Hanover	7%
Morgan Guaranty	9%
Nat.Bank of Nth.America	2%

This list may seem innocuous enough until you appreciate the complex inter-locking share structure, making assessment of 'who's at the top' nearly impossible.

Another list which made the circuit a few years ago, was given as being a list of the "true owners" of the Federal Reserve.

- 1 - Rothschilds of London
- 2 - Lazard Brothers of Paris
- 3 - Israel Moses Seif of Italy
- 4 - Warburg Bros of Hamburg
- 5 - Lehman Brothers of New York
- 6 - Kuhn Loeb of New York
- 7 - Chase Manhattan of New York
- 8 - Goldman Sachs of New York

From available information it would appear that the above list is probably the clearest picture of who 'owns the Fed'. One may note that 1/2 of the above are not even American.

The dedicated researchers amongst you will note that despite the obvious presence of the Rockefeller empire within the 'Fed', most of the above list are, allegedly, 'agents' of the Rothschilds.

Even the enormity of the influence of the Rockefeller empire fades into obscurity when compared to the inconceivable wealth of the Rothschilds.

To many Australians, the ownership of the 'Fed' seems like an obscure detail, even trivia. But how trivial is the realisation, that a few banking families may very well be controlling the global economy.

To consider that global money flow is privately controlled, challenges the ego in most, and it is a brave person indeed who can admit their own self-slavery to the money system.

*by I.O. Heaps.II*

# FROM CROP CIRCLES TO HIEROGLYPHS -

...the mystery continues...

One of the most intriguing mysteries of the decade has to be the phenomena known as "crop circles".

They are known as "crop circles" because the first reported cases, starting in 1976 in the UK, were literally that - circles of flattened corn, or other crops.

Since 1976, both the number and complexity of these 'circles', has increased dramatically.

No one knows exactly when the first 'circle' appeared, but we do know that since serious research first began in 1980, circles have literally popped up all over the place. For example, in 1987, 75 formations were discovered; 110 in 1988; 305 in 1989; and over 600 last year (1990).

Not only that, but what were originally circles 'evolved' into complicated 'pictograms' as illustrated below.

Listed below are some notes I made after sifting through masses of information now becoming available on the subject. I think the pictures of the "crop circles" however, speak for themselves.

\* The 'circles' range in size from 1 or 2m up to 70m in diameter.

\* they 'appear' most often during mid-summer and are most commonly found in southern England. Other circles have been found in the USSR, Italy, USA, Australia, Canada and Japan. Most however, are not as complex as those found in the UK last summer.

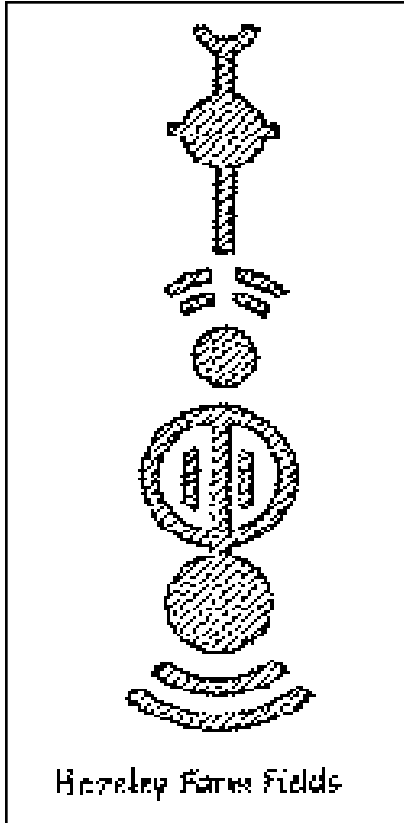

\* It has been discovered that the heaviest concentration of these 'circles' falls within the famous "Wessex Triangle", a well known area rich in mystical associations, containing ancient stone circles such as Avebury, Silbury Hill and Stonehenge. This area also has a history of abnormally high UFO sightings.

\* Several circles have been reported under high-voltage electricity wires, leading to much discussion of electromagnetic fields being the cause of the phenomena

\* Several "circles" have been found to be in a straight "line", observable only from the air. Many have speculated on the involvement of 'ley-lines' and changes in the Earth's magnetic fields.

\* Many people have seen "strange glowing lights" often orange in colour, and other UFO phenomena over fields prior to appearances of circles. Sometimes these sightings were days or weeks prior to an appearance of a 'circle'.

## INSIDE THE CIRCLES

There is a large amount of information emerging that deals with the "circles" themselves. I have listed below some of the effects of circles, as discussed by researchers.

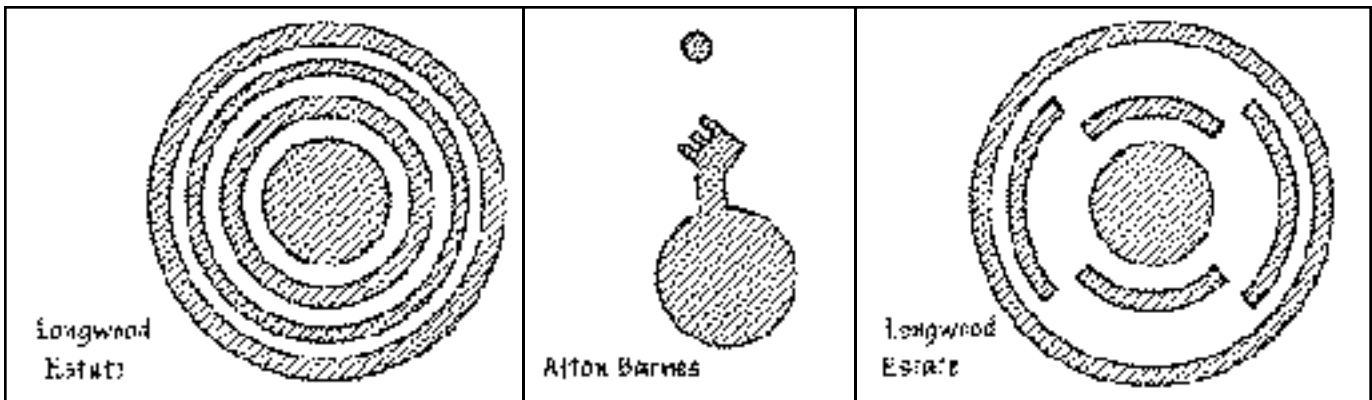

# & MORE CROP CIRCLES...

a) strange high frequency "twittering" sounds, which have been recorded and analysed, but are so-far unexplainable

b) "jelly-like" substances have been recovered from several circles

c) many researchers report feeling ill effects, such as headaches and nausea upon entering some circles. Dogs also are noticeably affected by the circles, with several illnesses reported.

d) some dowsing society people report 'dematerialising' and 'rematerialising' of certain objects, such as dowsing rods and wooden pegs

e) some researchers report "missing time" lapses during solo investigations

f) there are many reports of blinding white "flashes" and what appear to be electro-static 'crackling noises". Many of these occurred on cloudless days with multiple witnesses present.

g) analysis of plant samples taken from some circles shows dramatic molecular change has occurred.

h) electro-magnetic effects have been experienced in many cases, and some quite dramatically. For example on Thursday, August 10, 1989 at 3.30pm when a BBC television crew were filming two researchers in a 100 foot diameter circle near Avebury, Wiltshire. The camera refused to function properly each time it entered the circle, and several smaller circles nearby. Even when elevated on a crane over the edge of the circles, it would not work. The crew tried holding the camera outside the circle while the sound

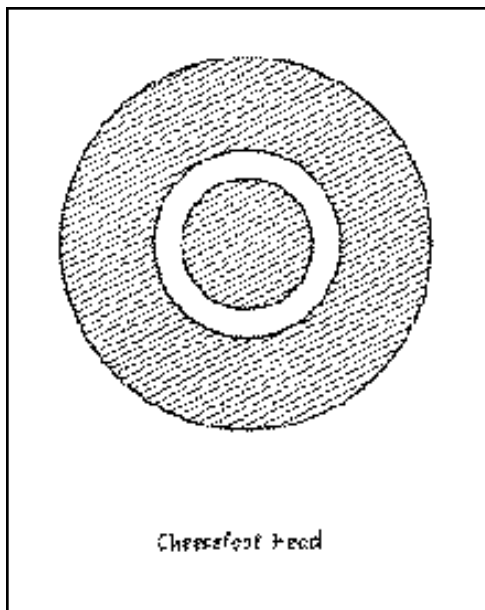

engineer went inside. As the camera rolled, and sound began taping, a loud, shrill, warbling noise blasted into the sound engineer's headset. Upon leaving the circle the noise stopped etc. The noise was recorded and sent to the BBC sound experts for analysis. All the BBC experts were baffled by the strange sounds. The camera was found to be completely defunct and had to be rebuilt. The event was shown on the BBC's "Daytime Live" program. As the transmission went to air, the electric supply into the whole studio complex was momentarily lost, and all telephones ceased functioning. Despite many varied and determined efforts to solve this baffling puzzle, the mystery remains. No doubt time will tell!

*Written by Duncan Roads*

## REFERENCES:

- "Crop Circles - The Latest Evidence" by Pat Delgado & Colin Andrews. (Publ Bloomsbury UK)
- "Crop Circles 1990" by Michael Chorost & Colin Andrews, *Mufon UFO Journal* #272, Dec 1990
- "A Crop of Circles" by Derek Elsom, *New Scientist*, 29 July 1989
- "More Circular Evidence" by Richard Beaumont. *Kindred Spirit*, Vol.1., No.8 pp.25-28.
- "Around and Around in Circles" from *Time*, Sept 18, 1989.
- "Corn Circles" by John Haddington. *Fountain International News*, #27.1990.

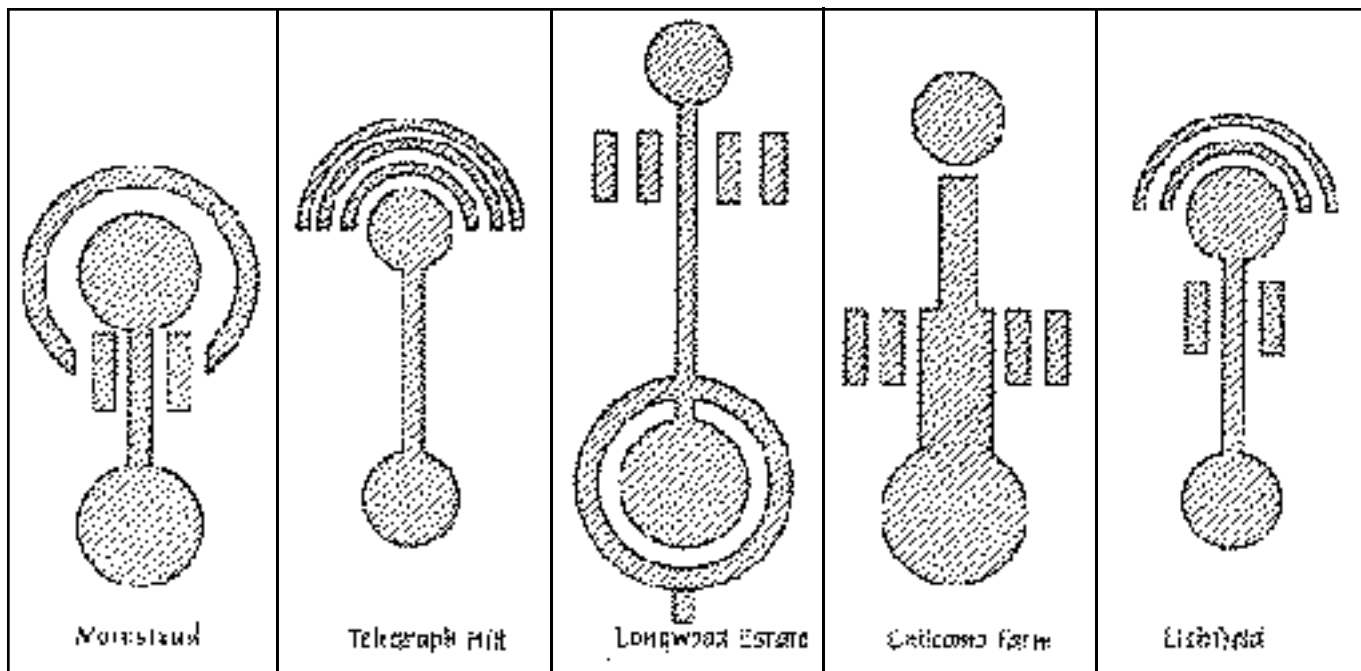

# WHY I CHANGED MY OPINION ABOUT FLUORIDATION

## A PUBLIC HEALTH OFFICIAL CHANGES HIS STAND ON ARTIFICIAL FLUORIDATION - AFTER CHECKING THE EVIDENCE FOR HIMSELF!

by John Colquhoun BDS Ph.D

My opinion on fluoridation was changed, after being an advocate of the procedure, because of evidence that fluoridation caused more harm than good to children and adults in my country.

Data which became available to me when I was a public health official revealed that, when similar populations were compared, more children were free of dental decay in the non-fluoridated area than in the fluoridated area. These data were collected for 98% of the child population of 12-13 year old children receiving their final treatment in the School Dental Service (Colquhoun 1984a, 1985, 1987).

Data collected over a 50-year period on the entire population of new 5 year old School Dental Service patients, together with earlier and recent published data, show that the decline in dental decay started well before the introduction of water fluoridation (Colquhoun 1988). Research in New Zealand (Hamilton & Birkbeck 1985) reports a great improvement in diet over that period, suggesting that better nutrition, rather than the introduction of fluorides, was more probably responsible for the decline in tooth decay.

On the other hand the prevalence of dental fluorosis, the disturbance of tooth formation which is an undeniable side effect of fluoridation, is much higher in fluoridation areas than had been predicted, and is significantly higher than in non-fluoridated areas (Colquhoun 1984b, Cutress et al 1985). Severity of dental fluorosis was also greater in fluoridated areas and among children given fluoride tablets (Colquhoun 1984b).

All this information has been published in peer-reviewed journals. The findings are supported by published data collected in

other countries (Diesendorf 1986a, Bille et al 1986, Gray 1987, Thylstrup et al 1979). In general, population data do not support sample studies which claim to show a benefit from one part per million fluoridated water.

I have since researched the history of the fluoridation campaign in my own and other countries. Documents, obtained under the new law which requires government departments to make their files available for public perusal, showed that the results of my country's first fluoridation trial were contrived, by changing the method of diagnosing for caries in the area of the experiment after the trial commenced. This information was published in the international environment journal "The Ecologist", 18 months ago (Colquhoun & Mann 1986, 1987). No attempt at refutation has yet been published.

Critical re-examination of early fluoridation research, on which the fluoridation theory is based, as well as of recent fluoridation research, shows that the effectiveness and safety of systemic uses of fluoride, for reducing tooth decay, have not been proven (Diesendorf 1986a,b, 1987, Colquhoun 1986, Sutton 1960). At best, the claims made were exaggerated. On the other hand substantial bodies of evidence pointed to toxic side effects (e.g. Grimbergen 1974, Schatz 1976, Waldbott et al 1978, Diesendorf & Sutton 1986, Sutton 1987) have been published, but overlooked by fluoridationists.

Indian scientists experienced in the study of fluorosis now believe that the maximum safe concentration of fluoride in drinking water is half a part per million (Susheela 1984, Srikantia 1984). While most dentists and many medical authorities continue to adhere to the fluoridation theory, scientists in other disciplines are increasingly questioning the wisdom of drinking water fluoridation.

Extracts from: Summary of address by John Colquhoun BDS Ph.D, to International Symposium on Fluoridation: Risks and Benefits. Porto Alegre, Brazil, May 18, 1988.

*Continued on page 31*

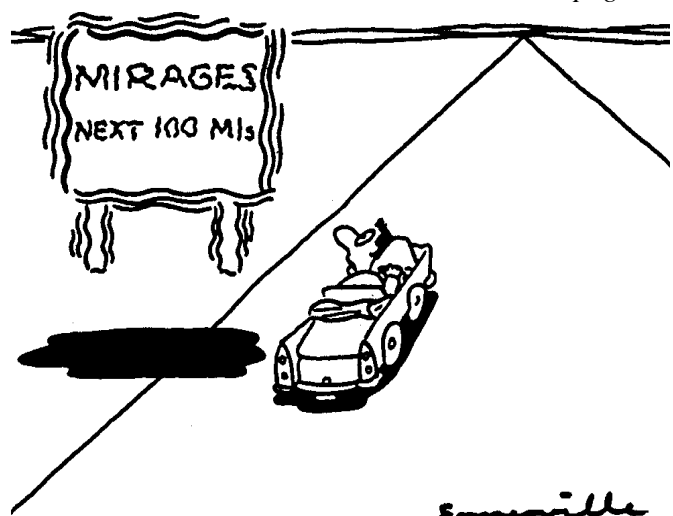

---

## ANOTHER ASTEROID "NEAR MISS"

While most of us were watching the middle-east missiles during January, another missile in the form of an asteroid became the closed "near-miss" of any asteroid yet observed.

Although only 5 to 10 metres across, this little bullet from beyond, had it hit the Earth, would have made a crater nearly 1km across and 30 metres deep. It would have hit the Earth at approx 20 km per second. (ie 76,000 km per hour)

Now known as 1991 BA, the asteroid, previously unknown, missed us by only 170,000km, which is less than half the distance from Earth to the Moon.

Source: - *Syd Morning Herald*, 25/1/91.

## CANCER RISKS & POWER LINES

According to a report commissioned by the Victorian Health Dept., high voltage electromagnetic fields more than doubled the risk of childhood cancers.

The report was based on epidemiological studies of frequencies in the range of 50-60Hz.

Based on three studies, the report concluded "This showed prima facie evidence that a residential exposure to power line frequency magnetic fields of at least 3mG is associated with an elevated risk of childhood cancer."

Source: *The Age*

## MYSTERIOUS NEW STRUCTURE FOUND IN SPACE

Astronomers have discovered an immense collection of galaxies, describing them as the biggest structure ever seen in the universe.

The structure, which they call the "Great Wall", is so difficult to explain that it raises new questions about theories of the origin and structure of the universe.

The galaxies that make up the Great Wall form a 'sheet' that is at least 500 million light years long, 200 million light years wide and 15 million light years thick.



The Great Wall was discovered by Margaret Geller and John Huchra of the Harvard-Smithsonian Centre for Astrophysics in Cambridge in a detailed three-dimensional map they have been compiling of a section of the heavens. The structure is so big that it appears to run off the edges of the map.

The researchers reported their discovery in a November issue of "Science".

## HAWKESBURY NEPEAN RIVER FACES DEATH

Sounds dramatic, but Sydney-siders be warned! The Managing Director of the Water Board, Mr Bob Wilson told a chemicals summit at Penrith last month, that the water quality of the Nepean-Hawkesbury system, which is Sydney's major source of drinking supplies, was deteriorating so rapidly that without remedial action, the river would die.

Source: *Syd Morn Herald* - 12/2/91

## 'DOUBLE-SPEAK' OR PROPAGANDA?

It seems that every time the US goes to war it has to invent a new language to smooth over the truth. This time it was the phrase "collateral damage" that made a lot of people feel a little queasy at hearing innocent human life described so callously.

It may interest some to learn that in previous "armed conflicts" or wars, several other descriptions were employed. For example, the US invasion of Granada was

---

"a pre-dawn vertical insertion of troops". In Vietnam, you didn't kill the enemy, you "serviced the target", "neutralised" somebody, or even better "de-humanised the enemy".

My favourite piece of "double-speak" occurred in '47, when the US Govt changed the name of the Dept of War, to the Dept of Defence.

## CARBON 14 TESTS OUT OF DATE

The popular method of dating ancient artifacts, particularly organic matter is the Carbon 14 dating method.

According to the Jan 1991 issue of "Diggings", a monthly archeological journal published in Sydney,

"some snail shell from antiquity were crushed and tested and found to be 37,000 years old. But in another test, the shells of some living snails were tested by the same method, and these also were found to be 37,000 years old."

Also, according to a report in *New Scientist*, the carbon dating of the Turin Shroud may have been inaccurate. The results of trials at 38 laboratories around the world which dated artifacts of known age were compared by Britain's Science & Energy Research Council (SERC). They revealed that the margin of error may be 2 to 3 times greater than at present accepted.

Worse still, the accuracy of accelerator mass spectrometry (AMS), the method used to date the Turin Shroud, came out of the survey badly and was "way out" when dating samples of less than 200 years old.

Source: *New Scientist*, 30/9/1989.

## ELECTRIC CURRENT DISCOVERED BENEATH AUSTRALIA!

A 6,000km long "loop" described as the world's longest electrical current has been discovered beneath Australia.

The "loop" stretches from Broome in WA down towards SA, up through western Qld, and out the Gulf.

The Australian current flows about 15km below the surface, sometimes deeper, with a width of about 50 to 200km.

A second current branches off the main one, just below Birdsville, and flows down into the Spencer Gulf.



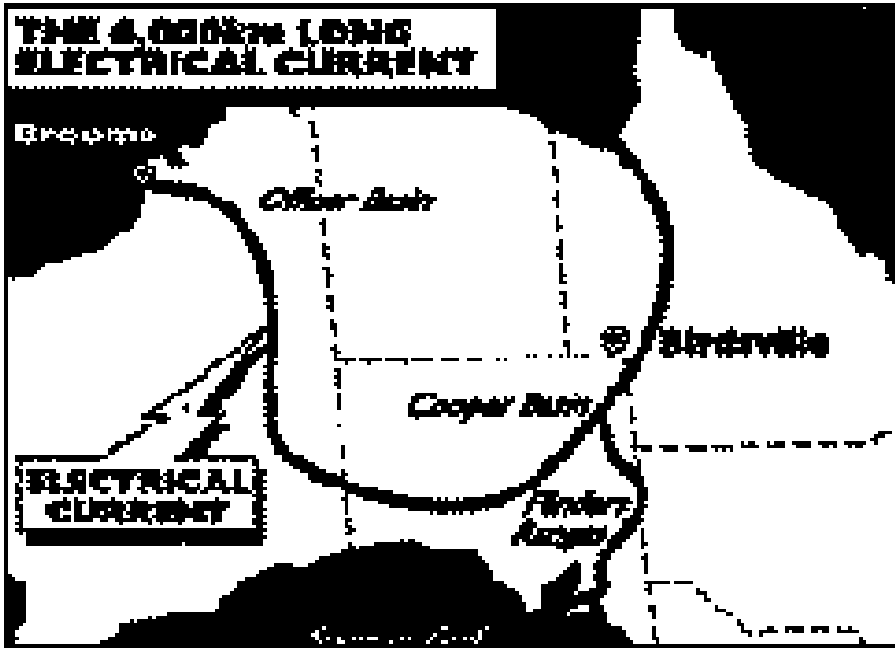

The interesting thing is that the currents pass through all the major oil and gas fields, including prospective areas such as the Officer Basin in WA.

According to the scientist who found it, Dr Francois Chamalaun of Flinders University, the current is a weak current, unable to light a lamp.

Similar flows of underground electricity, generated by changes in the Earth's magnetic field, have been discovered in North America and Canada.

Source: Sydney Morning Herald 11/3/91.

## MEDITATORS TO GET DISCOUNTED CAR INSURANCE

As early as January 1st, 1989, T.M. meditators began receiving a 30 to 50% reduction of their car insurance, without losing any services. A Dutch company, BERG-Diensten, has made this offer to drivers, who must take a 5 year policy and conduct two daily T.M meditations. The company claims statistics have shown that people who do T.M are simply not as big a risk. Characteristics about these meditators include - low alcoholism, virtually no anxiety or stress, quicker reaction time, and better perception. The company will also be providing discount on sickness insurance.

Source: World Research News; 1st Quarter 1991

## ECCENTRIC ASTEROID DISCOVERED

A newly discovered asteroid, named 1991DA, may force changes in theories about how the Solar System was formed.

The asteroid is on an unstable and highly elliptical orbit around the Sun, with an orbit taking it out beyond Uranus, which is about twice as far as any other known asteroid.

Australian astronomer Rob McNaught discovered 1991DA using the telescope at Siding Spring in NSW.

Source: New Scientist, 6th April 1991

## TELECOM OR TELECON?

Recent figures from Tart Research quote Telecom as Australia's largest spender on advertising, with \$34.4 million dollars spent.

One wonders what Telecom will do with the money raised from the proposed increase in phone charges - they certainly are not paying their technicians who have recently gone on strike for a pay rise to bring them up to the award wage.

Maybe it will go into funding more of those 'top-secret'

high security buildings like the one in Herbert St, St Leonards NSW, or Dandenong Rd, Vic.

## POLICEMAN CAUGHT SHOPLIFTING!

While viewing a video-tape recording of a shoplifter in action, some English police were shocked to discover he was their own crime prevention officer.

Raymond Bate was fined, and has quit the force.

Source: Telegraph-Mirror 22/2/91

## FLUORIDATION BLACKMAIL?

The *NORTHERN STAR*, Lismore (12/11/90) reported what amounts to be stand-over tactics by the NSW Dept of Health, against the Lismore people's stand against artificial fluoridation

Part of the NSW Health Dept letter to the Council reads...

"It appears that plans to provide School and Hospital Dental Services at the proposed Goonellabah Health Centre won't be funded unless Council reconsiders its decision on fluoridation of water supplies."

The same pressure was applied to Coffs Harbour City Council, according to *The Advocate*, (8/11/90), giving them a choice of "fluoridate", or no extra "funds". They stated that **additional dental funding should only be for fluoridated areas!**

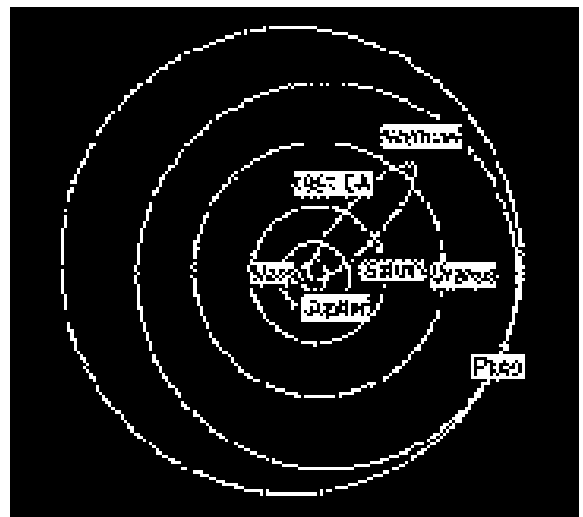

Far out: the asteroid's orbit spans the Solar System from Mars to Uranus and beyond

If fluoride actually did reduce tooth decay, surely there would be less need for Dentists in fluoridated areas, not more!

## INDONESIA SEEN AS SECURITY THREAT TO AUSTRALIA

The rumours of a future Indonesian invasion of Australia have gathered momentum with the release of a new survey.

Ian McAllister from the Defence Force Academy in Canberra claims that up to 24% of Australians perceive Indonesia as the biggest threat to Australia's security.

*(Source: Sunshine Coast Daily, Friday April 5, 1991)*

## FEDERAL POLICE FEUDS BENEFIT CORRUPTION

The departure from the Australian Federal Police (AFP) of organised crime expert Peter Lamb has helped cause more serious operational and morale problems. The old rivalries between former ACT and Commonwealth police, (who combined in 1979) has even led to senior officers refusing to talk to each other about day to day operations.

Several disasters have been identified which apparently were 'caused' by this breakdown in communications and morale.

### 1. The Wallace Affair.

Michael Wallace, an AFP officer who worked in "the vault", the place where seized drugs are stored. Last July he was sentenced to 12 years jail after being busted with assorted drugs, including 9 kilos of heroin. He also had \$237,000 in cash, and it is anyone's guess how much heroin and cocaine he sold before being caught. There was no internal investigation because no-one asked for one.

### 2. Operation Sleep .

After a tipoff from Customs, the AFP put 16 kilos of cocaine under surveillance last year. Normally a substitute is used, but not this time. Within about 5 minutes of the surveillance starting, the observation squad lost it. (The cocaine that is).

It has never been found.

*Source: The Eye, June Quarter 1991*

# MOTHER SHIPTON'S PROPHECY

This is a rare collection of the prophecies of Mother Shipton. Very recently I received from a reader these remarkable verses, which I have tried to leave intact, both in the order they were translated, and in the wording. There were several lines that I already had, but were not to be found in this larger version of her works. I have included these extra lines and identified with them by surrounding them with [...]

A carriage without horse will go  
Disaster fill the world with woe.  
In London, Primrose Hill shall be  
In centre bold a Bishop's See

Around the world men's thoughts will fly  
Quick as the twinkling of an eye.  
And water shall great wonders do  
How strange. And yet i shall come true.

[Then upside down the world shall be  
And gold found at the root of tree]

Through towering bills proud men  
shall ride

No horse or ass move by his side.  
Beneath the water, men shall walk  
Shall ride, shall sleep, shall even talk.  
And in the air men shall be seen  
In white and black and even green

A great man then, shall come and go  
For prophecy declares it so.

In water, iron, then shall float  
As easy as a wooden boat  
Gold shall be seen in stream and stone  
In land that is as yet unknown.

And England shall admit a Jew  
You think this strange, but it is true  
the Jew that once was held in scorn  
Shall of a Christian then be born.

A house of glass shall come to pass  
In England. But Alas, alas  
A war will follow with the work  
Where dwells the Pagan and the Turk

These states will lock in fiercest strife  
And seek to take each others life.  
When North shall thus divide the South  
And Eagle build in Lion's mouth  
Then tax and blood and cruel war  
Shall come to every humble door.

Three times shall lovely sunny France  
Be led to play a bloody dance  
Before the people shall be free  
Three tyrant rulers shall she see.

Three rulers in succession be  
Each springs from different dynasty.  
Then when the fiercest strife is done  
England and France shall be as one.

The British olive shall next ten twine  
In marriage with a German vine.  
Men walk beneath and over streams  
Fullfilled shall be their wondrous dreams.

[All England's sons that plough the land  
Shall oft be seen with Book in hand  
The poor shall now great wisdom know  
Great houses stand in farflung vale  
All covered o'er with snow and bail]

[And now a word, in uncouth rhyme  
Of what will be in future time]

For in those wondrous far off days  
The women shall adopt a craze  
To dress like men, and trousers wear  
And to cut off their locks of hair  
They'll ride astride with brazen brow  
As witches do on broomstick now.

And roaring monsters with man atop  
Does seem to eat the verdant crop  
And men shall fly as bi rds do now  
And give away the horse and plough.

There'll be a sign for all to see  
Be sure that it will certain be.  
Then love shall die and marriage cease  
And nations wane as babes decrease  
And wives shall fondle cats and dogs  
And men live much the same as hogs.

In nineteen hundred and twenty six  
Build houses light of straw and sticks  
For then shall mighty wars be planned  
And fire and sword shall sweep the land.

[When pictures seem alive with  
movements free  
When boats like fishes swim beneath  
the sea,  
When men like birds shall scour the sky  
Then half the world, deep drenched in  
blood shall die]

For those who live the century through  
In fear and trembling this shall do.  
Flee to the mountains and the dens  
To bog and forest and wild fens.  
For storms will rage and oceans roar  
When Gabriel stands on sea and shore  
And as he blows his wondrous horn  
Old worlds die and new be born.

A fiery dragon will cross the sky  
Six times before this earth shall die  
Mankind will tremble frightened be  
for the sixth herald in this prophecy

For seven days and seven nights  
Man will watch this awesome sight.  
The tides will rise beyond their ken  
To bite away the shores and then  
The mountains will begin to roar  
And earthquakes split the plain to shore.

And flooding waters, rushing in  
Will flood the lands with such a din  
That mankind cowers in muddy fen  
And snarls about his fellow men.

He bares his teeth and fights and kills  
And secrets food in secret hills  
And ugly in his fear, he lies  
To kill marauders, thieves and spies.  
Man flees in terror from the floods  
And kills, and rapes and lies in blood  
And spilling blood by mankind's hands  
Will stain and bitter many lands

And when the dragon's tail is gone,  
Man forgets, smiles and carries on  
To apply himself - too late, too late  
For mankind has earned deserved fate.

His masked smile - his false grandeur,  
Will serve the Gods their anger stir.  
And they will send the Dragon back  
To light the sky - his tail will crack  
Upon the earth and rend the earth  
And man shall flee, King, Lord, and serf

But slowly they are routed out  
To seek diminishing water spout  
And men will die of thirst before  
The oceans rise to mount the shore.

And lands will crack and rend anew  
You think it strange. It will come true.  
And in some far off distant land  
Some men - oh such a tiny band  
Will have to leave their solid mount  
And span the earth, those few to count,

Who survives this (unreadable) and then  
Begin the human race again.  
But not on land already there  
But on ocean beds, stark, dry and bare

Not every soul on Earth will die  
As the Dragon's tail goes sweeping by  
Not every land on earth will sink  
But these will wallow in stench and stink  
Of rotting bodies of beast and man  
Of vegetation crisped on land.

But the land that rises from the sea  
Will be dry and clean and soft and free  
Of mankind's dirt and therefore be  
the source of man's new dynasty.

And those that live will ever fear  
The dragon's tail for many year  
But time erases memory  
You think it strange. But it will be.

And before the race is built anew  
A silver serpent comes to view  
And spew out men of like unknown  
To mingle with the earth now grown

Cold from its heat and these men can  
Enlighten the minds of future man.  
To intermingle and show them how  
To live and love and thus endow  
The children with the second sight.  
A natural thing so that they might  
Grow graceful, humble and when they do  
The Golden Age will start anew.

The dragon's tail is but a sign  
For mankind's fall and man's decline.  
And before this prophecy is done  
I shall be burned at the stake, at one  
My body singed and my soul set free  
You think I utter blasphemy  
You're wrong. These things have come  
to me  
This prophecy will come to be.

€€€€€€€€

*The following words were on the outer  
wrapping of the scrolls.*

I know I go - I know I'm free  
I know that this will come to be.  
Secreted this - for this will be  
Found by later dynasty

A dairy maid, a bonny lass  
Shall kick this tome as she does pass  
And five generations she shall breed  
Before one male child does learn to read.

This is then held year by year  
Till an iron monster trembling fear  
Eats parchment, words and quill and ink  
And mankind is given time to think.

And only when this comes to be  
Will mankind read this prophecy

But one man's sweet's another's bane  
So I shall not have burned in vain.

*Mother Shipton*

*This section was kept separate to the  
other and appears to have been written  
together yet was in a different jar.*

The signs will be there for all to read  
When man shall do most heinous deed  
Man will ruin kinder lives  
By taking them as to their wives.

And murder foul and brutal deed  
When man will only think of greed.  
And man shall walk as if asleep  
He does not look - he may not peep  
And iron men the tail shall do  
And iron cart and carriage too.

The kings shall false promise make  
A talk just for talking's sake  
And nations plan horrific war  
The like as never seen before  
And taxes rise and lively down  
And nations wear perpetual frown  
Yet greater sign there be to see  
As man nears latter century

Three sleeping mountains gather breath  
And spew out mud, and ice and death.  
And earthquakes swallow town and town,  
In lands as yet to me unknown.

And christian one fights christian two  
And nations sigh yet nothing do  
And yellow men great power gain  
From mighty bear with whom they've lain.

These mighty tyrants will fail to do  
They fail to split the world in two.  
But from their acts a danger bred  
An age - leaving many dead.  
And physics find no remedy  
For this is worse than leprosy.

Oh, many signs for all to see  
The truth of this true prophecy

**Born in Norfolk, England  
circa 1386-1388.  
Traditionally identified as  
Ursula South'ill (or South'iel),  
she was married at 24 years of  
age to a builder, Tony Shipton.  
Mother Shipton, as she came to  
be known, was burned at the  
stake in Clifton, circa 1449,  
aged over seventy years old.**

# HERBAL TREATMENTS for COMMON AILMENTS

by Gregory Ah Ket.BA., MNHAA.

## STINGING NETTLE

*Urtica dioica, U. urens*

**Action:** Alternative, haemostatic, diuretic, astringent, galactagogue.

**Systems Affected:** Lungs, liver, kidneys, bladder, blood.

**Preparation and Dosage:** (thrice daily): Dried flowering plant, dose 2-5 grams by infusion.

The term Stinging Nettle is often used of three distinct species: the Greater Nettle (*Urtica dioica*), the Lesser or Smaller Nettle (*U. urens*) and the Roman Nettle (*U. pilulifera*). The former is a tall perennial whereas the later two are shorter annuals, but all have similar properties.

These species of Nettle are native to Eurasia but have been introduced and naturalised elsewhere, especially on moist fertile wasteland. The botanist J.H. Willis states that *U. urens* is common in Australia but *U. dioica* is rare or non-existent as a naturalised plant (examples of the plant supplied for botanical identification usually turn out to be *U. urens*, more vigorous in growth because of the warmer climate).

Nettle is valued for its haemostatic properties, regular doses of the infusion being used as a treatment for frequent nose bleeds and for haemorrhaging from the nose, lungs, stomach, uterus and haemorrhoids. To stop nose bleeds the dried powdered leaf is used as a snuff or a piece of cotton wool soaked with the expressed juice of the plant is inserted in the nostril.

Rich in chlorophyll, containing Vitamin A and C, mineral salts such as calcium, potassium, silicon, iron, manganese, and sulphur, plus other substances, Nettle is sometimes used in anaemia and for its alternative or tonic effects on the blood and, especially when combined with Burdock, is of great benefit in skin eruptions and eczema, being specific for eczema of nervous origin.

Nettle is considered of some benefit as an anti-asthmatic: the juice of the plant, mixed with honey or sugar, is used to relieve bronchial and asthmatic troubles and the dried leaves are smoked as a cigarette to the same effect.

The plant is sometimes used to treat rheumatism and gout, internally as a tonic and externally as an application where the effected parts are beaten with a fresh plant! (This painful form of treatment, used by the ancient Romans and by many others since, is regarded

by those who employ it as being highly effective in relieving chronic rheumatism.)

Nettle is used for its galactagogue properties and as a treatment for bedwetting in children. It is reported to have hypoglycaemic properties (ie. to lower the blood sugar level). The infusion provides a soothing and healing lotion for burns.

It is a highly-esteemed tonic for the scalp. To stimulate hair growth, rendering it soft and glossy, and to prevent falling hair and eliminate dandruff, a strong decoction of the plant is used every other day as a shampoo or Nettle juice is combed through the hair daily.

Nettle has been variously used in cloth and paper manufacture, as a food, a medicine, a dyestuff and livestock feed. Nettle fibre, similar to flax, was used in different times, particularly in northern Europe, to make sheets tablecloths and linen, sailcloth, sacking, ropes and nets. (The fine cloth resembles silky linen in feel and appearance.)

Cut and dried, Nettle is given as a supplementary feed to livestock: it increases milk production in cows and egg production in poultry, and imparts condition and sleek coats in run down horses.

A decoction of the plant yields a permanent green dye and the roots, boiled with salt or alum, produce a beautiful yellow colour.

The young plants, 15 to 20 cm high, are eaten as a cooked vegetable in many cultures. A strong decoction of the plant can be used as a substitute for rennet. Strained, cooled and added to warm milk, it will curdle it without imparting a strong flavour.

Flies have a distaste for the plant and a fresh bunch of Stinging Nettles helps to keep a kitchen or pantry free of them.

The whole plant is downy and covered with stinging hairs that cause severe pain on even slight contact. The carbonic and formic acids that cause the stinging are broken down into harmless compounds within a few days when the plant is cut and dried, and are immediately rendered inactive when exposed to heat. Thus the dried herb may be safely handled and consumed, and the fresh plant is readily used when cooked or boiled. The expressed juice is made by bruising the leaves and subjecting them to low heat for thirty minutes, then ringing them out in a cloth

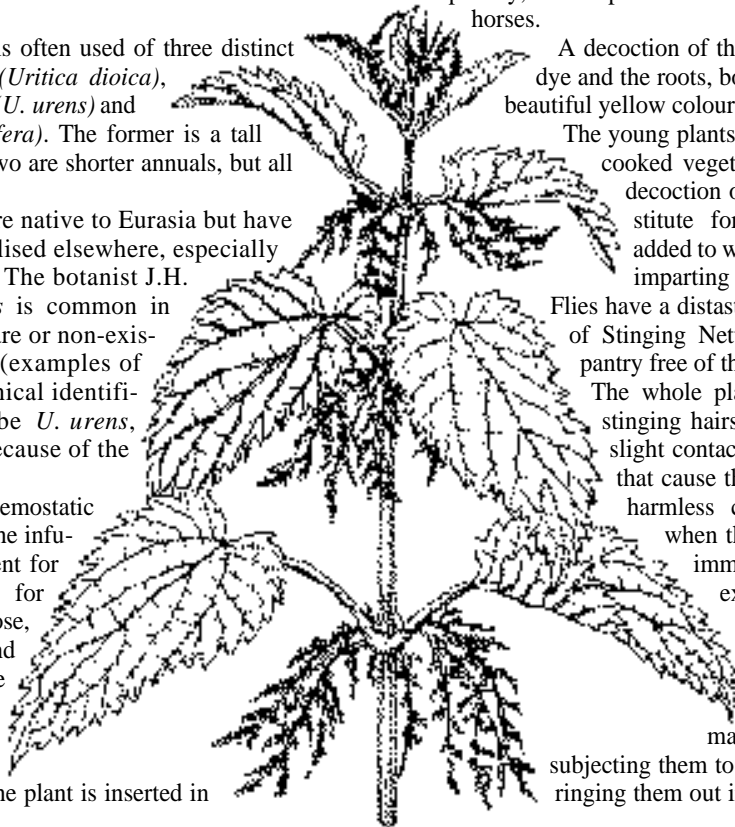

### Cautionary Notes:

Gloves should always be worn when handling the fresh plant.

The recommended antidote to Nettle rash is fresh Aloe Vera, Yellow Dock or Plantain leaves bruised and rubbed on the effected area. Rosemary, Mint or Sage Leaves, and the juice of the Nettle itself, will also provide relief.

Extracted from the book "Herbal Treatments for Common Ailments" by Gregory Ah Ket, BA., MNHAA. Published by Compendium Pty Ltd, this book is available at leading bookshops and newsagents. Mail orders are available at \$16.95 per copy (+\$3- P+P), from Blake & Wasson's Bookshop, GPO Box 1591, Melbourne, Vic.3001. Copyright (c) Gregory Ah Ket 1990.

# THE PERSECUTION & TRIAL OF GASTON NAESSENS

THE TRUE STORY OF THE EFFORTS TO SUPPRESS AN ALTERNATIVE TREATMENT FOR CANCER, AIDS, AND OTHER IMMUNOLOGICALLY BASED DISEASES.

Author: Christopher Bird  
Publisher: H J Kramer Inc., CA. USA  
Review by: Catherine Simons

History has presented us with many brilliant people, some of whom choose to explore past the accepted boundaries. It is unfortunate that these adventurous pioneers are often scorned or even persecuted, as is the case with Gaston Naessens.

Gaston's contribution to controversy is a microscope he invented while in his twenties. Able to manipulate light in a way still not wholly accountable to physics and optics, this microscope has allowed Naessens a unique view into a "microbeyond" inaccessible to those using state-of-the-art instruments.

## THE "SOMATIDS"

It was in this "micro-beyond" that Gaston discovered microscopic forms far more miniscule than any previously revealed.

Christened *somatids* (tiny bodies), they circulate by the billions in the blood of every man, woman, child, as well as in the blood of all animals, and even in the sap of plants.

In fact some scientists now consider these ultramicroscopic, subcellular, living and reproducing forms seem to constitute the very basis for life itself.

Gaston Naessens's trip to hell was a direct consequence of his having dared to wander into scientific terra incognita. For it is a sad fact that, these days, in the precincts ruled by the "arbiters of knowledge", disclosure of "unknown things" instead of being welcomed with excitement, is often branded as rubbish - and not even given a chance to stand for itself.

In the multi-billion dollar pharmaceutical industry, with its experts and research programmes in tow, such a device as presented by Gaston, if successful, would make a lot of sick people healthy, plus put a lot of people out of business.

In 1985, Gaston Naessens was indicted on several counts. In late 1989 he was found innocent. The trial was kept out of the media for obvious reasons.

The microscope developed by Gaston in the 1940's permitted practitioners to view living matter at 150Å of resolution - which is still far greater than state of the art microscopes currently available.

Using this microscope he made some interesting discoveries. In his own words Gaston explains "You see I've been able to establish a life cycle of forms in the blood that add up to no less than a brand new understanding for the very

basis of life. What we're talking about is an entirely new biology....".

Gaston's discovery of the somatid led to a discovery that these somatids follow a cycle which is visible in the blood of every human being. The cycle becomes more complicated in a diseased or unhealthy organism long before any symptoms are present. Thus it is able to pre-diagnose degenerative diseases up to 18 months earlier!

From this Gaston discovered a compound he named 714-X, which was found to restore to perfect health, 750 out of 1,000 cancer victims. It had equally dramatic effects with AIDS and MS patients.

The approach used by Gaston was to strengthen and enhance the body's natural immune system, rather than the remove and destroy approach of the established medical system.

One of the most dramatic statements during his trial was made by the last defence witness, a judge named Wilhelm whose wife had recovered from cancer by using 714-X. He said "That such treatments as Naessen's 714-X, are not publicly available is more than distressing. Why do they have to be hidden? After all in our society any of us would make any and all attempts to rescue, to save, a drowning man, woman or child.... so why not a victim of cancer?"

The trial, although an obvious attempt to suppress his discoveries by litigation, served to bring more attention from some sectors of the public. In a recent seminar held for interested Doctors, Gaston just about summed up the current state of affairs with the following.

"Man has almost completely lost the right to think, or to create, outside the norms established by a scientific dictatorship. For over a hundred years, this scientific hegemony, became a trillionaire, has taken deep root throughout the world to the detriment of the health of its populations. This aberrated status in present day scientific thinking, resisted by a growing number of conscientious researchers, will be overcome only if people as a whole, begin to work peacefully, yet with conviction, to smash a medical "Berlin Wall" erected by vested interests."

The microscope developed by Gaston in the 1940's permitted practitioners to view living matter at 150Å of resolution - which is still far greater than state of the art microscopes currently available.

# The Rise & Rise of the Khazars

## WHO, OR WHAT, ARE THE KHAZARS?

To find out, a great deal of research is necessary, which in this case can be a difficult task due to the small number of books available. It seems a deliberate attempt over the centuries has been made to eliminate all traces of this once great trading empire, which was situated on the eastern confines of Europe between the Caucasus and the Volga, and on the major trade route between China and Europe, commonly referred to as the "Silk Trade Route".

I say once great trading nation as a reference to what they were, as a nation they no longer exist, but as a people they are well and thriving and the most influential and powerful body on Earth.....

This is their story in brief!

The strategic position of the Khazar empire on the Silk Trade Route was a very important factor in establishing and consolidating their influence not only in the Asia Minor region but throughout the civilised world at that time - circa 7th Century to 13th Century AD. All the leaders of the major powers from time to time had dealings with the Khazar Empire, which were important not only for trading reasons but because the Empire was a bulwark to the advance of the Arab conquests into Eastern Europe. Not only were the Khazars masters of trade and commerce, they were also a highly organised military force and ferocious fighters well able to defend their territories. Thus they became natural allies of the European powers against the Arab nations who were intent on spreading the Muslim faith. These friendly contacts of the West became the Khazar's major commercial resource which they expertly utilised and manipulated politically to suit their purposes. There is nothing unusual in that as this is the norm for any nation to develop and protect itself, except that the Khazars were no ordinary race of people and their plans and objectives went far beyond the conceptual thinking of any nation of that time or since.

It seems a deliberate attempt over the centuries has been made to eliminate all traces of this once great trading empire...

## THEIR CULTURE

To further understand the aims of the Khazars, it is necessary to have a feel of their culture, which in many aspects was unique and akin to Shamanism. The spiritual world was to them an integral part of each of their lives, not embodied in a religion as is the case in all other non pagan civilisations but a personal living experience which influenced their daily thoughts and actions. It seems what made them unique was that to the western civilisations the Khazars were a power to be reckoned with despite being in their estimation pagans and therefore inferior. Unable to understand the Khazar

culture they were an easy prey for the astute Khazars, who unlike other pagan races were a highly organised trading power able to employ sophisticated commercial techniques.

The Khazars did not fit into any known religious dogma and were not perceived as posing a threat to Western interests. Indeed, trade flourished between the two cultures, however Christians, Jews and Muslims sought to convert the Khazars to their respective faiths. Both Arabs and Christian powers saw the Khazar Empire as a jewel to be coveted and possessed, but neither had the ability to conquer it. Over the centuries there were many attempts from both sides and also there were many warlike nomadic tribes who caused considerable devastation to the smooth running of the trading process. The Khazars of course were well aware of the competition for their conversion to one of the established faiths and gave a lot of thought regarding the best course of action to take.

The Khazars were ruled superficially by a king who was referred to as Khagan. He was chosen more or less at random by the real powers of the land who are difficult to name, but were magicians and high ranking merchants who operated as an occult sect.

Part of the Khazar culture practised by the people was to exchange identity with complete strangers. Usually this happened when travellers met on their journeys - they would camp for the night and exchange stories about their families, business affairs and so on; often the outcome would be the complete exchange of identity, so that for the rest of their lives they would

have a different family and way of life.

The foregoing is a significant feature of their culture and enables the student to comprehend how the Khazars seemingly disappeared and yet imparted an everlasting influence on the World's future.

## THEIR PLAN

This is how they planned it. Tired of the continuous wars and border skirmishes which threatened the stability of their Empire, and the trade which had brought them power and influence with other nations, the rulers conceived an imaginative and bold plan which was to be carried out in the utmost secrecy if it was to succeed. Moreover the secrecy had to be maintained forever or until such time as the power it was to bring them was unquestionable.

The first stage of their plan was to arrange "a polemic", a meeting between the leading philosophers of the three major religions of the region - Muslim, Christian and Jewish. Invitations were sent for the respective representatives to come before the Khagan in three year's time in order that they could prepare and also learn the language and customs of the Khazar culture. The purpose of the meeting was to debate the merits of the respective religious beliefs and practice so that the Khagan could choose which of them would

best suit the Khazar people in order that they may adopt it and thereby be accepted as a civilised race.

The outcome was as planned, each of the representatives gave a good account of themselves and left believing that the Khagan would decide for the Khazar people to adopt their respective beliefs and religious culture.

This is exactly what the Khazars had planned. Through the expert diplomacy of the Khagan and his advisers planted the seed of trust in the minds of his learned visitors.

Such an intellectual conquest by the Khazars over the visitors brought great rewards. The hierarchies of each of the three religions accepted the Khazars into their esoteric midst and shared the secrets and objectives of their cultures.

## THEIR SECRET

Such knowledge covertly secured from the three religions and hidden from each of the other two by the Khazars enabled them to use such confidentiality and knowledge to their advantage. Acting from within they manipulated affairs to their advantage and thereby increased their power and influence in the affairs of the world at that time until the present. Their own empire had served its purpose and just like any Khazar person they adopted the customs and cultures of their neighbours and merged themselves unobtrusively over a period of time and established secret orders within each of the three religions. The inner circle of the Khazar ruling body established a network of control within the hierarchy of the respective religions. Thus it became established over the centuries without even the most celebrated scholar being aware of its existence.

The three secret orders established and controlled by the Khazars were the Muslim Brotherhood, the Knights Templar, and the Zionists. Each of them were manipulated from without by powers within, under strict hierarchical control. As a result, there were pacts and counter pacts between all three, designed to prevent any particular order from gaining dominance over the other two. For instance, the Knights fought against the Muslims and were rewarded for their deeds on the field of battle by being given land rights by the Church. Money was loaned to them by (Khazar) Jewish traders in order to establish a feudal system and in return were given the right to trade on advantageous terms. As time progressed, the traders used their wealth to loan money to individual Kingdoms and other influential powers, thus in addition to being traders, they also became the power brokers of Europe. They practised lending money to both sides of warring factions, thereby always ending up on the winning side, and in fact, their wealth was a great determining factor in the outcome of wars.

The King of France and the Catholic Church, who at that time had its headquarters located in Avignon, France, became gravely concerned at the apparent power and influence of the Knights Templar and regarded them as a threat to their own influence and power. As a consequence, the Knights Templar were purged of their lands and many of them were killed. The elite secret orders put roots down into the middle classes

and new lesser orders were formed, the Freemasons being just one of them. Plots were made and popular uprisings were brought about leading to the downfall of the French King - hence a new dawn in the history of Mankind was born via the French Revolution. To this day important families which took part in this irreversible trend of using the masses to obtain and manipulate power under the name of democracy - still enjoy their positions of influence. How and by what means they are connected to the ancient power of the Khazars is known only to a few. Some believe it to be the "Illuminati" and as far as western Christian esoteric orders are concerned this maybe the case. Certainly there is circumstantial evidence to suggest that World War II was planned by two opposing factions of the Illuminati order - The Bavarian Illuminati founded by Weishaupt attempted to usurp the older established order, but whichever side were victorious, the outcome ultimately would be the same - in keeping with the Khazar policy.

Although the apparent motives are materially based and modern day cultures in the western democracies are focussed on control of the Earth's resources, the ultimate aims of the powers that initiated the whole process are focussed on the possession of, and control over, the souls of Mankind. Therefore, in order that their aims bear fruit they have to ensure through devious means that souls of individuals are not allowed to be awakened. By actively cultivating cultures which rely on matter only as their sustenance, their corporate bodies find the means to survive from the dormant souls - easy prey to superior entities who need spiritual sustenance by absorbing spiritual energy.

Just as matter cannot be destroyed, neither can Spirit, but in both cases their state can be changed and absorbed. It is up to each of us to make sure we are awake to the dangers that surround us, be they material or spiritually related.

*Extracted from an article written by Allan Cooke, Sept 1990.*

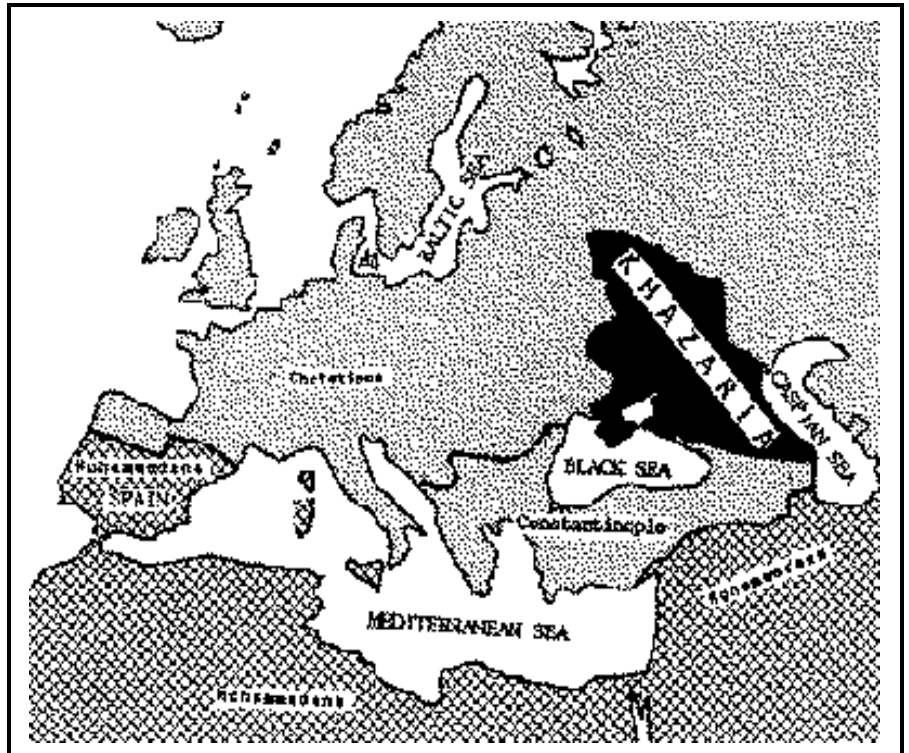

THE NATION OF KHAZARIA - C. 900 A.D.

Simplified copy of the map of the 9th Century nation of Khazaria found in the Jewish Ency



# CHALLENGING THE SUNLIGHT - SKIN CANCER CONNECTION

by Dr. Ronald S. Laura, Professor in Education, University of Newcastle  
& John F. Ashton, Chief Chemist, Sanitarium Research Laboratories

**In what follows it will be argued that the orthodox explanation of skin cancer and the assumptions about the dangers of sunlight which underpin it are highly misleading and may in fact be contributing unwittingly to the very behaviour responsible for the increase in melanoma.**

The orthodox view of the increasing incidence of melanoma depends upon the assumption that regular exposure to sunlight is the main cause of skin cancer, a cause which is now all the more to be feared as the progressive depletion of the ozone layer leads in turn to an increase in the levels of ultraviolet light to which the human body is exposed.

Substantial evidence has now accumulated to challenge the assumption that the increase in melanoma which has occurred since the 1960's is a matter simply of environmental exposure to ultraviolet radiation. Contrary to the conventional wisdom, it would appear that the ability of the body to defend itself against melanoma depends upon sufficient exposure to natural sunlight, and that our ever increasing exposure to artificial light may have far more to do with the incidence of melanoma than has been supposed.

Throughout the history of the human species, exposure to sunlight has figured as a common experience of everyday life. Today, however, we find in modern urbanised countries that our relationship with the environment has changed markedly. By having progressively synthesized the world in which we live, our contact with the natural environment is rapidly becoming minimal. Many people now make their way to work just as the sun is rising and make their way home once the sun has set. For many people the world of artificial light has replaced the world of natural sunlight, as they spend most of their day working indoors. Interestingly, there is evidence which establishes a

higher incidence of melanoma among indoor workers and among those of higher social class. It is also revealing that the distribution of melanomas across the body is often higher on parts of the body least exposed to sunlight. (1)

Compounding the problem are a number of environmental factors which may actually increase the sensitivity of our skin to sunlight. By 1964 more than 100 chemical agents, including many commonly used drugs, had been documented as increasing the sensitivity of the skin to natural light. Within the class of photosensitizing drugs are found hypoglycaemic, antihypertensive, tranquilliser, broad spectrum antibiotic drugs, and even sunscreens and tanning lotions. (2) Around the same period reports of photoallergic reactions to artificial sweetener cyclamate was added to the list in 1967. (3)

The processing and refining of our food is also thought to increase skin sensitivity and thus reduce skin tolerance to sunlight. (4) There is evidence that a deficiency of B6 in the diet, for example, increases photosensitivity to ultraviolet light. Vitamin B6 levels in grains are considerably diminished in the milling and refining process, with white bread containing only 22% of Vitamin B6 compared with wholemeal bread (5). On the other hand it is ironic that our cereals are fortified artificially with other chemicals such as riboflavin, which is itself a potential photosensitizer.

While factors such as the above increase our sensitivity to sunlight, the beneficial effect of sunlight on the regulation of our hormonal system in a way that helps to prevent melanoma needs to be addressed. For many years female sex hormones, for instance, have been suspected as being important in the induction of melanomas. It has been shown that there are oestrogen receptors in melanoma cells and there is evidence to suggest that oral contraceptives may increase the risk of the disease. (6) Women who take high-dose oral contraceptives or who become pregnant sometimes develop patchy pigmentation around their face, as increased oestrogen levels appear to stimulate pigment synthesis in melanocytes. (7) It is also known that the human ovulatory cycle is regulated and normalised by natural light. (8)

In regard to the rising incidence of melanoma, one hypothesis is that the healthy formation of skin pigmentation is regulated in subtle ways by light entering the body through the eyes as well as the skin. Since different regions

of the light spectrum are involved in maintaining a delicate balance between these two pathways, artificial indoor light with its distorted spectral composition and monotony compared to daylight, tends to stress the feedback and complementary mechanisms between the two systems, thus disrupting the production of adequate levels of protective melanin in the skin. As we increase our exposure to artificial light, we may thus be undermining the body's own defense mechanisms which would otherwise protect us against everyday exposure to the harmful rays of the sun.

An illustration of the importance of sufficient exposure to sunlight relates to changes which occur in the surface fat layer of the skin. This layer offers the first protection against ultraviolet light. Earlier studies showed that ultraviolet radiation seemed to increase the cholesterol content of the skin, and it was suggested that the increased cholesterol may actually predispose the skin to tumour. (9) Subsequent and more detailed studies have shown, however, that the higher the cholesterol level of the skin, the greater was its resistance to the harmful effects of ultraviolet radiation. (10). Again the optic light connection is of relevance here. Lipid metabolism and blood cholesterol levels are regulated by light affecting the optic pathway to the pineal system, and again different spectral bands such as those manifest in artificial light appear to affect the eye and skin intake systems in ways which degrade the body's protective mechanisms against melanoma.

Vitamin D synthesis is another case in point. Recent research has demonstrated that the prohormone Vitamin D levels are regulated conjointly by the pineal gland and exposure of the skin to sunshine, thus emphasising the subtle interconnection between the optic and skin stimulation by light. (11) This is especially significant as evidence accumulates suggesting that Vitamin D inhibits melanoma and other cancers. (12) Using unnatural fat sources, such as polyunsaturated margarines to manipulate dietary fat can also affect the balance of the mechanisms which regulate the optimum fat composition of the skin. The possibility that the manipulation of dietary fat is an important factor in the aetiology of melanoma has also been mooted. (13).

The artificial colours with which we have painted and decorated our environment have served to ensure that for large periods of time the nature of the light entering our eyes is vastly different from the light reflected from the natural outdoors of meadow, forest and field. In addition the use of glass, sometimes plastic coated or tinted, means, for example, that the sunlight entering our building or vehicle is filtered or refined by the removal of certain wavelengths of sunlight by the glass itself. This diminished sunlight is usually supplemented by artificial lighting from incandescent or fluorescent lights.

It is clear then that apart from the progressively rarer occasions when we step outdoors, we are continuously bathing in artificial light. Yet, dare we step outside? Health departments warn us constantly through the media to beware of the skin cancer demon called sunlight. We are urged to protect ourselves from direct sunlight by using sunscreens. We do this winningly, but we fail to recognise that when we coat our skin with sunscreens or tanning oils, and even wear sunglasses, the sunlight light reaching the covered areas of skin and our eyes has been modified or refined by the absorption of certain wavelength components. Exposure to natural sunlight has again been reduced

or transformed into exposure to artificial light.

This bizarre situation has arisen because little attention has been paid by health educators to the accumulating literature which points to the fact that the substitution of artificial light for natural sunlight is an important etiological factor in understanding the melanoma enigma. Lest the discussion be misunderstood, let us make plain that the recommendation is not that we should all run off to the beach at the first blush of summer sun. On the contrary, the point is that regular daily exposure, *not excessive exposure and sporadic*, to sunlight is an important measure in the prevention of melanoma. It needs also to be recognized that some of the very chemical substances upon which we have come to rely to make us healthy may inadvertently be contributing to our ill health.

## References

1. Giles, G., Dwyer, T., and Coates, M. et. al. "Trends in Skin Cancer in Australia an Overview of the Available Data" in the "The Ozone Layer and Health", op.cit., pp.143-147; see also Cox, B., and Coombs, B. "Trends in Melanoma of the Skin in New Zealand", ibid., pp.137-140.
2. Lee, J.A.H., and Strickland, D. "Malignant Melanoma: Social Status and Outdoor Work", British J Cancer, Vol.41, 1980, pp.757-763; see also "The Aetiology of Melanoma", Editorial, The Lancet, January 31, 1981, pp.253-255.
3. Young, S.W. "A List of Photosensitizing Agents of Interest to the Dermatologist", Bull. Assoc. Milit. Derm., Vol.13, Mar '64, pp.33-35
4. Epstein, J.H. "Phototoxicity and Photoallergy: Clinical Syndromes", in Sunlight and Man, Fitzpatrick, T.B., et.al. editors, Tokyo, University of Tokyo Press, 1974, pp.459-469
5. Driskell, J.A. "Vitamin B6", in Handbook of Vitamins, Machlin, L.J. editor, New York, Marcel Dekker Inc., 1984, p.385.
6. Lee, J.A.H., and Storer, B.E. "Excess of Malignant Melanomas in Women in the British Isles", The Lancet, December 20/27, 1980, pp.1337-1339; see also Beral, V., Ramcharan, S., and Faris, R. "Malignant Melanoma and Oral Contraceptive Use Among Women in California", British J. Cancer, Vol.36, 1977, pp.804-809
7. Annon. "Possible Oestrogen Use Against Melanoma", Laboratory News, Sydney, August 1989, p.12.
8. Luce, G.G. Body Time, Melbourne, Sun Books, 1972, pp.241-242.
9. Baumann, C.A., and Rusch, H.P. "Effect of Diet on Tumors Induced by Ultraviolet Light", American J. Cancer, Vol.35, 1939, pp.213, 220.
10. Mackie, B.S., Johnson, A.R., and Mackie, L.E. et.al. "Dietary Polyunsaturated Fats and Malignant Melanoma", Medical J. Australia, February 23, 1980, pp.159-163.
11. Stumpf, W.E. "The Endocrinology of Sunlight and Darkness. Complementary roles of Vitamin D and Pineal Hormones", Naturwissenschaften, vol.75, #.5, 1988, p.247.
12. Colston, k., Colston, M.J. and Feldman, D. "1,25-Dihydroxyvitamin D3 and Malignant Melanoma: The Presence of Receptors and Inhibition of Cell Growth Growth in Culture", Endocrinology, Vol.108, No.3, 1981, pp.1083-1086; see also Garland, C., and Shekelle, R.B. et.al. "Dietary Vitamin D and Calcium and Risk of Colorectal Cancer: A 19 Year Prospective Study in Men", The Lancet, Feb. 9, 1985, pp.307-309.
13. Chedekel, M.R. and Zeise, L. "Sunlight, Melanogenesis and Radicals in the Skin", Lipids, Vol.23, No.6, 1988, p.590.



# THE NEXUS GUIDE TO- MIND ENHANCEMENT TECHNOLOGIES

## Build Your Own Recession-Fighting "Guerilla Goggles"

Those of us who have been tempted by the glittering alchemy of Light and Sound "Mind Machines" could be a little confused by now. Only one thing seems consistent. Each purveyor of electronic good times promotes their newly imported product as "THE best". Well, the one you can build from this article definitely isn't the best ... but it is the CHEAPEST! For about \$5-, if you have an old pair of sunnies and a soda can.

### SEEING THE LIGHT

Some unbridled "futants" spend over 200 times as much for extra sound effects, frequency readouts or automation. If you're REALLY serious, it is worth the expense ... and in all fairness, this complexity is costly to manufacture. But it's icing on the cake, not the underlying principle. To help with your decision, we will list the performance options available, using our home-made optical stimulator as a point of departure. After all, the one thing they all have in common is flashing lights, fitted to anything from ski goggles to wrap-around safety glasses.

But first our cybernetic psychologist, Dr. Anne Droid, wants to say that the brain's electrical activity can be tuned to any rhythm you want by applying pulsed energy through the senses. This is most easily done with LIGHTS and

SOUND. What results is the "frequency following response", also termed "entrainment".

Depending on the speed of stimulation introduced, the mind will translate it into a corresponding level of subjective awareness. Commercial mind machines generate a synchronous audio/visual output, variable in rate from about 1 to 30 cycles per second. Within this "ELF" range lie the biological triggering mechanisms for nearly all our moods and inner resources. There is some evidence that repeated use actually opens up NEW neural pathways, or those not turned on by ordinary influences in the environment.

### CONSUMER REPORT

Meanwhile, back at the lab, we are dissecting a representative sampling of this year's high-tech gadgetry, and putting their common features into separate smoldering piles. We'll leave it to you to correlate this raw data with your actual needs, and specific brand names. Here's what their basic differences look like to the informed researcher.



### OPTICAL STIMULATION

Source: miniature incandescent or solid state Light Emitting Diodes (LED's). The former boasts "full spectrum", but red, typically the colour chosen for the latter, is

a more penetrative nerve activator. Green is occasionally used, but this is more colour therapy. LED's come in a wide range of brightness. Dimmer controls are relevant to relaxation, but maximum light creates the stunning internal imagery, and kaliedoscopic patterns that pull your attention inside. Some models can flash alternate left and right eye, theoretically accessing each brain hemisphere function in sequence, as opposed to merging them. More uncommon, is a cluster of LED's that "rotate", expand or contract. Transparent lenses allow you to see past the lamps, an advantage for reading retention, or superimposing a nostalgic psychedelic flicker on the outside world. A few have an infrared emitter over the forehead, presumably to awaken the fabled "third eye", doorway to inner space. Activating waveform: most are a simple, square on/off pulse. these are not single frequencies, in that all odd harmonics of the rate selected are present. A pure rising and falling wave, with a higher proportion of "on" to "off" time, is preferable to anyone but a computer, and now used exclusively in our devices.



capability and unlimited availability of sounds. Secondly, the impact of music, recorded affirmations, or guided "vision quests" is enhanced by synergetic light patterns evoked on the screen of the mind.

This is accomplished intuitively by the user, according to the inner sensations preferred, or with reference to a numeric readout. The latter is often associated with digital circuitry, which may have a memory chip enabling a session of migrating frequencies to be entered on a keypad, stored, and called up at a later date. Some systems are sold with factory-set programs for relaxation, creativity, problem solving, etc. Here's where individual choice and budget come in. If the object is self-exploration, an operator who is guided by experiential landmarks within the "mindscape" itself, can achieve more fluid response by the turn of a single knob ... calibrated or not. These are specific patterns of light and colour that always occur at the same frequency. This approach is becoming more learnable, as devices with increasingly potent sensory interfaces enter the marketplace. the only rationale for "computerised", push button gear is its self-contained, predefinable, time-variant functions. Its drawbacks include incremented rather than smooth pulse rate transitions, and restricted improvising once a program is started. If accurate calibration is wanted for systematic research, any in-built metering, and the circuitry it monitors, should have a resolution of at least



Applied through ordinary stereo headphones in, or sometimes 180 degrees out of, phase with optical pulses to reinforce the entrainment effect. This may be a repetitive tone, sometimes with a pitch control and volume you can adjust to your liking. Synthesized "white-noise", similar to wind or rushing water, is also commonly used for its universal appeal and awareness-captivating properties. Heartbeats, "lasers", tropical birds, etc are available at a price. Some leading-edge products now offer the BINAURAL, or "holophonic", effect. The user "hears" a compelling internal beat, derived WITHIN the brain itself from separate audio tones fed to each ear. These are tuned by the operator to differ from each other by the exact psychoactive frequency desired. (See Nexus Vol.2 #1) for a full description. The visual output of certain goggles can also be modulated in tempo with an external audio source, such as a cassette player. This is useful in two instances. Firstly, the tape may contain lamp-triggering pulses of any sound desired, that shift in repetition rate over its duration, constituting a graduated "journey" to a certain level of awareness and back. This has the same effect as expensive computer sequencing, but is better adapted to implementing new trends, with its stereo/holophonic

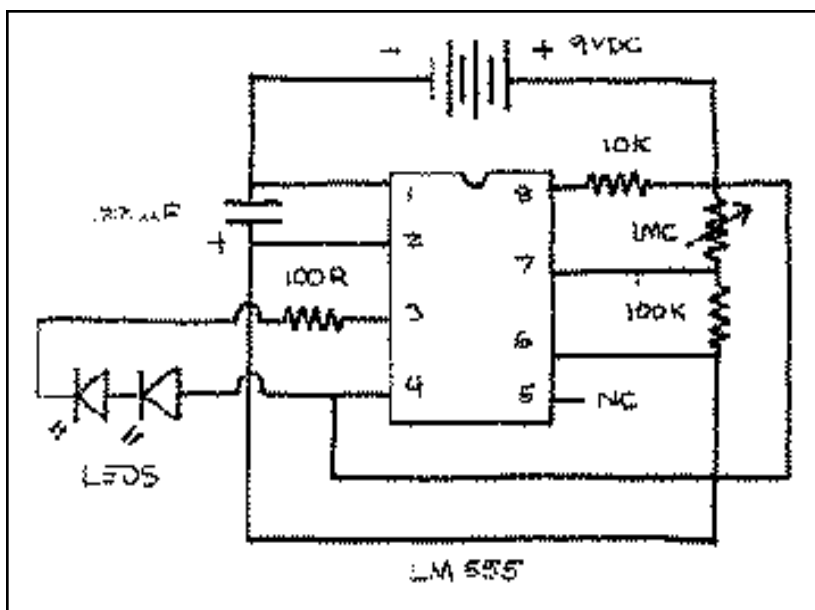

# THE NEXUS GUIDE TO MIND ENHANCEMENT TECHNOLOGY

1/10th cps, if not 1/100th. The latter would be required for replicating the popularised Schumann atmospheric resonance of 7.83 cps., or new effects you may wish to document at precise, mind-altering "window" settings.

Well, those are the basics. A few diverging contenders throw in a supplementary magnetic field (see Nexus Vol.2 #2) and/or direct electrical skin stimulation. The latter is effective, to the extent of being harsh if consideration is not given to the actual wave SHAPE introduced. It is the basis of some tape activated brain "therapy" units that have no light or sound. Trials are now being done with focussed external potentials, or "scalar waves", which are far more biologically reactive, and may be applied at a distance. A facility to plug in two sets of goggles and headphones is ideal for shared exploits, counselling and telepathy experiments. While portable goggles seem handy, limits on battery life favour either simplicity, or power-conserving digitised circuits that talk in rectilinear pulses, instead of more organic waveforms. Some researchers are looking to reshape the latter, thereby adding a secondary "feel", or EMOTIONAL component. In other laboratories, an exciting new generation of mind machines is emerging. These sense the total mental AND physical response to applied stimulation, and modify each deepening step of the entrainment process accordingly, supported by a computer generated VIRTUAL REALITY. The subject interacts with this changing landscape in 3D through a stereoscopic video eyeshield, and motion sensors attached to a full body suit. Its fluid topography mirrors the inner dynamics of the mind ... and the mind responds instantaneously to its projected alternate reality. The interplay accelerates until there is no separation.

## INNER CITY

A few preliminary suggestions for using any recreational mind machine. Please refrain, if you are epileptic, nervously disordered, on medication, wearing a heart pace-maker, or have just seen the movie "Altered States". Never twiddle the knob back and forth. This may irritate the mind, which is unable to track the rapid changes. Keep your eyes closed and to avoid strain look "through", rather than "at", the internal imagery produced. Always start a session at a relatively high rate of pulsation and proceed SLOWLY downward. For efficient brainwave capture to occur, the applied stimulation rate must at some initiatory stage pass through that of your pre-existing level of awareness. Allow a suitable rest period afterward, before engaging in any demanding activities. If unwanted effects are ever encountered, discontinue use immediately. All information in this article is speculative, and subject to verification by the researcher at his or her own risk. Prospective buyers of mind machines seeking an update on the latest developments, are invited to contact the author through Nexus Magazine. I think that covers everything.

The accompanying CIRCUIT DIAGRAM on the opposite page shows a simple pulse generator for your "guerrilla goggles". The IMC potentiometer is wired in reverse. Trim its range with the 100K resistor, if required. You can drop

the whole board into an inconspicuous soda can. Other recycled housing would be a plastic soap case, Vegemite jar, or hollowed out physics text-book. To mount the red LED's, drill through the plastic lenses of any sunglasses. Take them off first. If you buy the high intensity clear type, the focussing end MUST be filed flat for safe diffusion. NEVER apply other than a 9 volt transistor battery to this circuit.

## SELF-EVOLUTION

Now that you've checked out our project, here are some ideas for its use from other researchers. Let's procede from the higher pulse rates downward. At the upper end, corresponding to our "normal" waking state, combined physical and mental activities are favoured, such as dealing with everyday practicalities.

You will see the most vibrant geometric patterns here, and slightly lower in the intricate area of concerted thought, reasoning or analysis. That was the so-called "Beta" range. Nothing special. More subtle levels follow, conducive to creative inspiration, learning and seeing things in novel ways. Then emerge pleasurable states of "non-directed alertness", or calm receptivity ... the beginning of intuition. As the level of mental "noise" diminishes, our liberated awareness attunes to higher dynamics, and the revitalising capacity of direct perception. Passing through this "Alpha" zone, we now enter "Theta", for deeper relaxation, meditation and spiritual ideals. The final is "Delta", home of dreamless sleep, trance and an elusive borderland of self-transcending experiences. Along the pathway are found these beneficial "key" frequencies, and others that may repel you. This is where personal sensitivity comes in. Find the balance between the machine controlling you, and you controlling the machine ... where there is finally no control at all.

Happy goggling!

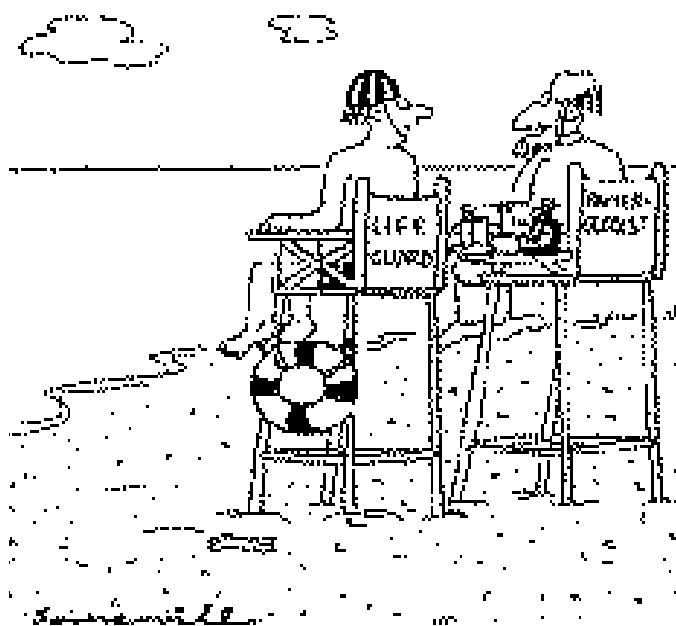

# UFO's - ROSWELL REVISITED

**AFTER 43 YEARS,  
NEW WITNESSES  
REVEAL THEIR  
EXPERIENCES OF  
THE UFO CRASH  
NEAR ROSWELL.**

There were four — two dead, one dying, one apparently uninjured. The creatures were about 4 feet tall, with heads disproportionately large for their bodies by human measure and almond-shaped, coal black eyes. They huddled in the shadow of 50-ft-diameter silver disk - a "flying saucer" that had crashed into a low hillside on the rim of what locals call the Plains of San Augustin.

Anderson, a former police chief at Rockaway Beach and Taney County deputy sheriff who now works as a security officer in Springfield, is adamant about events on the hot midsummer day so long ago. "I saw them. I even touched one of the creatures. I put my hand on their ship. And I wasn't alone - my dad, my uncle, my brother and my cousin all saw the same things. And so did a lot of other people. But they aren't talking.

Anderson is talking, publicly, after 43 years of silence. Among those listening most intently are some of the foremost researchers into UFO phenomena.

Anderson says he was unaware of ongoing fascination and controversy over the strange episode from his childhood until one evening this past January(1990) when he was flipping through channels on his TV set and stumbled across the popular program "Unsolved Mysteries."

On sudden impulse, he dialed a phone number that flashed onto the screen. "I guess I figured that if people were still interested in this thing, they might as well get it straight" is the only explanation he can muster for speaking up after years of keeping mostly mum on the matter.

Anderson's phone soon was ringing with calls from UFO researchers around the country.

One in particular, Stanton Friedman, a nuclear physicist and popular lecturer who had advised the "Unsolved Mysteries" producers, was struck by correlations between Anderson's recollections and obscure details Friedman uncovered while sleuthing for a book to be published next year. Friedman contacted John Carpenter, a Springfield professional therapist who in his spare time serves as a director of investigations for the local chapter of MUFON, a nationwide organization of UFO researchers.

Carpenter put great stock in Anderson's recountings under hypnosis. "It's what he didn't say that was significant." Carpenter says, explaining that despite clever prodding, Anderson never committed a hoaxer's mistake of "recalling" something that shouldn't be a part of his own memory.

The Anderson family arrived in Albuquerque from Indiana on July 4, 1947. they took up temporary residence at the home of one of Gerald's uncles, Guy Anderson. Gerald's father, Glen, was about to take a job as a master machinist involved in nuclear weapons design at the super-secret Sandia base on the outskirts of town.

The next day, another uncle, Ted, struck up a conversation with Gerald's older brother Glen Jr., who was on leave from the Marine Corps. Glen Jr. was a rockhound, and his uncle piqued the young Marine's enthusiasm with talks of gorgeous stones just waiting to be collected in the desert. "Ted told my brother, 'I know where there's plenty of moss agate.' So we all piled into a 1940 Plymouth - Uncle Ted, my cousin Victor (Ted's 8 year old son), my brother, Glen, my dad and myself. We went out into this area where the moss agate was supposed to be, followed two ruts into the desert, bounced along out there for a while, and ended up on top of a ridgeline.

We parked the car and started to walk down an arroyo (gully) and dry creek bed and out onto the plains.

But we came around a corner and right there in front of us stuck into the side of this hill, was a silver disc. We all went up there to it. There were three creatures, three bodies, lying on the ground underneath this thing in the shade. Two weren't moving and the third one obviously was having trouble breathing, like when you have broken ribs. There was a fourth one next to it, sitting there on the ground. There wasn't a thing wrong with it, and it apparently had been giving first aid to the others.

**"I even touched one of the creatures. I put my hand on their ship - my dad, my uncle, my brother and my cousin all saw the same things. And so did a lot of other people. But they aren't talking."**

Anderson animatedly acts out the fourth creature's reaction when the family members approached. "It recoiled in fear, like it thought we were going to attack it," Anderson recounts, covering his face with crossed arms. The adults tried to repeatedly to communicate with the frightened creature, Anderson says, but there was no audible response to greetings spoken in English and Spanish.

A few minutes after the Anderson clan happened upon the bizarre scene, six other people arrived - five college students and their teacher. They'd been working on an archaeological dig around cliff dwellings a few miles away and had decided to hike

# UFO'S - ROSWELL REVISITED

over after seeing what they thought was a fiery meteor crashing the night before.

The professor, a Dr. Buskirk, tried several foreign languages in unsuccessful attempts to coax a verbal response from the creature, Anderson says. The sun had climbed to a midday peak by this time so he sought shelter in the shadow of the spacecraft. "It was 115 (degrees) out there that day, but around the craft, when you got close to it, it was cold. When you touched the metal, it felt just like it came out of a freezer." Anderson also touched one of the creatures lying motionless on the ground - and it, too was cold.

A pickup truck arrived on the ridge, and a fellow whom researchers believe was a civil engineer named Barney Barnett joined the curious audience. "I remember thinking he looked like Harry Truman. In 1947, every kid knew what Harry Truman looked like," Anderson says.

After a few minutes, Anderson summoned the courage to again creep close to the strange saucer. It was then more chilling than the surface of the craft of the skin of the corpse; The upright creature turned and looked right at me and it was like he was inside my head, as if he was doing my thinking, as if his thoughts were in my head." Anderson remembers a mental sensation of falling and tumbling end-over-end. "I felt that thing's fear, felt its depression, felt its loneliness. I relived the crash. I know the terror it went through. That one look told me everything that quickly," he says with a snap of his fingers.

Other things began happening quickly about this time, Anderson says. A contingent of armed soldiers suddenly appeared. The creature, which had calmed down after its initial fright, "went crazy" at the sight of the soldiers.

Thinking back on the creature's plight today brings on the "awfullest, horrible feeling," Anderson says. "His situation was hopeless. He knew it. He'd just lived through a nightmare that most of us wouldn't be able to psychologically stand. He'd watched two of his crew, his friends or maybe even his family die. He's watching another one die. He knows there's no chance of rescue, because the military is here and his people aren't going to be able to get him. "God only knows how far away from home he was, and he knew he was never going to see - if they have loved ones - his loved ones again. He was totally alone on a hostile planet, and the only people who were showing him kindness were being run off by the military at weapon-point. "

As a kid, I was aware of what being afraid of the dark was like., and the feeling I got from him was that feeling multiplied a million times. It was scary. It was terrifying.

Anderson says he lost sight of the creature as the soldiers swarmed over the site. The civilians were brusquely shoved from the craft. Anderson remembers shouts and threats. His uncle Ted threw a punch at one of the GIs. "Things got very tense, very dangerous," Anderson says. "The soldiers ushered us out of there very unceremoniously. Their attitude, to describe it at best, was uncivilized."

Anderson has an especially vivid memory of a tough-talking red haired Army captain and an equally gruff black sergeant. "They told my dad and my uncle, who also worked at Sandia, that if they were ever to divulge anything about this - it was a secret military aircraft, they said - then us kids would be taken away and they'd never see us again."

It seems an outrageous threat in hindsight, Anderson concedes. But at the time, he reminds, "These people had machine guns and you listened to what they said."

Another recollection strikes Anderson as odd today: The soldiers didn't appear surprised about the otherworldly craft and creatures. they didn't gawk, slack-jawed and awe-struck as the Andersons had done. They were very cognizant of what they were looking at, and it soon became apparent, Anderson says, that the Army knew what it wanted to do with the find. "there was a battalion of military, a real invasion force, when we got back up on the hilltop.

There were trucks, there were airplanes - they had the road blocked off and they were landing on it. They had radio communications gear set up. There were ambulances, and more soldiers with weapons."

In the days that followed, all of New Mexico was abuzz with talk of strange lights in the sky, strange echoes on radar, strange doings in the desert.

On July 7, new reports told of remnants of an unidentified aircraft found by a rancher near the town of Roswell, N.M. about 150 miles east of the hillside where the Anderson's stumbled upon the saucer. Although several witnesses said it was like nothing they'd ever seen before, military officers insisted the metallic pieces came from an ordinary weather balloon.

Forty three years later, Anderson smiles wryly when reminded of the Army's pronouncement, "A lot of people wondered why, if it was just a weather balloon, the military put the pieces under armed guard and flew them in a B-29 to Wright Patterson Air Force Base in Ohio," he observes.

"There was a gash in the side of the disc we saw, like it had been crushed in," he says. "The contour of the craft would fit into that gash perfectly - like another one of these things had hit it. I think two of these discs had a mid-air collision. One exploded and fell in pieces near Roswell, and the other crash-landed where we found it.

Of the five Anderson men who ventured into the desert that day in 1947, only Gerald is still alive. Age, illness and accidents claimed the other four in recent years.

But not only the Andersons were at the scene, Gerald says, and he hopes his decision to come forth, albeit belated, will encourage others to tell what they know and spur official revelations about the captured craft and creatures. "I want to see the government stand up and say, 'Look, we're not alone in the universe.

*(Taken from an article in the NEWS-LEADER, a newspaper from Springfield, Missouri, dated Sunday, December 9, 1990.)*

**"They told my dad and my uncle, that if they were ever to divulge anything about this - then us kids would be taken away and they'd never see us again."**

# The Battle for Your Mind

## Hi-tech brainwashing & your TV

*In the entire history of humanity, no one has ever been brainwashed and realised, or believed, that they had been brainwashed!*

### MASS MISUSE

I could relate many stories that support subliminal programming, (refer to last issue of Nexus) but I'd rather use my time to make you aware of even more subtle uses of such programming.

I have personally experienced sitting in a Las Angeles auditorium with over ten thousand people who were gathered to listen to a current charismatic figure. Twenty minutes after entering the auditorium, I became aware that I was going in and out of an altered state. Those accompanying me experienced the same thing.

Since it is our business, we were aware of what was happening, but those around us were not. By careful observation, what appeared to be spontaneous demonstrations were, in fact, artful manipulations. The only way I could figure that the eyes-open trance had been induced was that a 6 to 7 cycle per second vibration was being piped into the room behind the air conditioner sound.

That particular vibration generates alpha, which would render the audience highly susceptible. Ten to 25% of the population is capable of a somnabulistic level of altered states of consciousness; for these people, the suggestions of the speaker, if non-threatening, could potentially be accepted as "commands."

### VIBRATO

This leads to the mention of VIBRATO. Vibrato is the tremulous effect imparted in some vocal or instrumental music, and the cycle per second range causes people to go into an altered state of consciousness.

At one period of English history, singers whose voices contained pronounced vibrato were not allowed to perform publicly because listeners would go into an altered state and have fantasies, often sexual in nature. People who attend or enjoy listening to singers like Mario Lanza are familiar with this altered state induced by the performers.

### ELF's

Now, let's carry this awareness a little further. There are also inaudible ELF's (extra-low frequency waves). These are electromagnetic in nature. One of the primary uses of ELF's is to communicate with our submarines. Dr Andrija Puharich, a highly respected researcher, in an attempt to warn US officials about Russian use of ELF's, set up an experiment. Volunteers were wired so their brainwaves could be measured on an EEG. They were sealed in a metal room that could not be penetrated by a normal signal.

Puharich then beamed ELF waves at the volunteers. ELF's go right through the earth and, of course, right through metal walls. Those inside couldn't know if the signal was or was not being sent. And Puharich watched the reactions on the technical equipment: 30% of those inside the room were taken over by the ELF signal in 6 to 10 seconds.

When I say "taken over", I mean that their behaviour followed the changes anticipated at very precise frequencies. Waves below 6 cycles per second caused the subjects to become very emotionally upset, and even disrupted bodily functions. At 8.2 cycles, they felt very high ... an elevated feeling, as though they had been in masterful meditation, learned over a period of years. 11 to 11.3 cycles induced waves of depressed agitation leading to riotous behaviour.

### THE NEUROPHONE

Dr Patrick Flanagan is a personal friend of mine. In the early 1960s, as a teenager, Pat was listed as one of the top scientists in the world by "Life Magazine". Among his many inventions was a device he called the Neurophone - an electronic instrument that can successfully program suggestions directly through contact with the skin. When he attempted to patent the device, the government demanded that he prove it worked. When he did, the National Security Agency (NSA) confiscated the neurophone. It took Pat two years of legal battle to get his invention back.

In using the device, you don't hear or see a thing; it is applied to the skin, which Pat claims is the source of special senses. The skin contains more sensors for heat, touch, pain, vibration, and electrical fields than any other part of the human anatomy.

In one of his recent tests, Pat conducted two identical seminars for a military audience - one seminar one night and one the next night, because the size of the room was not large enough to accommodate all of them at one time. When the first group proved to be very cool and unwilling to respond, Patrick spent the next day making a special tape to play at the second seminar. The tape instructed the audience to be extremely warm and responsive and for their hands to become "tingly". The tape was played through the neurophone, which was connected to a wire he placed along the ceiling of the room. There were no speakers, so no sound could be heard, yet the message was successfully transmitted from that



# The Battle for Your Mind

wire directly into the brains of the audience. They were warm and receptive, their hands tingled and they responded, and according to programming, in other ways that I cannot mention here.

The more we find out about how human beings work through today's highly advanced technological research, the more we learn to control human beings. And what probably scares me the most is that the medium for takeover is already in place! The television set in your living room and bedroom is doing a lot more than just entertaining you.

Before I continue, let me point out something else about an altered state of consciousness. When you go into an altered state, you transfer into right brain, which results in the internal release of the body's own opiates: enkephalins and Beta-endorphins, chemically almost identical to opium. In other words, it feels good ... and you want to come back for more.

Recent tests by researcher Herbert Krugman showed that, while viewers were watching TV, right-brain activity outnumbered left-brain activity by a ratio of two to one. Put more simply, the viewers were in an altered state... in trance more often than not. They were getting their Beta-endorphin "fix".

To measure attention spans, psychophysiological Thomas Mulholland of the Veterans Hospital in Bedford, Massachusetts, attached young viewers to an EEG machine that was wired to shut the TV set off whenever the children's brains produced a majority of alpha waves. Although the children were told to concentrate, only a few could keep the set on for more than 30 seconds!

Most viewers are already hypnotised. To deepen the trance is easy. One simple way is to place a blank, black frame every 32 frames in the film that is being projected. This creates a 45 beat-per-minute pulsation perceived only by the subconscious mind - the ideal pace to generate deep hypnosis.

The commercials or suggestions presented following this alpha-inducing broadcast are much more likely to be accepted by the viewer. The high percentage of the viewing audience that has somnambulistic-depth ability could very well accept the suggestions as commands - as long as those commands did not ask the viewer to do something contrary to his morals, religion, or self-preservation.

The medium for takeover is here. By the age of 16, children have spent 10,000 to 15,000 hours watching TV - that is more time than they spend in school! In the average home, the TV set is on for six hours and 44 minutes per day - an increase of nine minutes from last year and three times the average rate of increase during the 1970's.

**From a talk delivered by Dick Sutphen at the World's Congress of Professional Hypnotists Convention, Las Vegas, USA.**

**..what probably scares me the most is that the medium for takeover is already in place....  
the television set!**

It obviously isn't getting better ... we are rapidly moving into an alpha-level world - very possibly the Orwellian world of "1984" - placid, glassy-eyed, and responding obediently to instructions.

A research project by Jacob Jacoby, a Purdue University psychologist, found that of 2,700 people tested, 90% misunderstood even such simple viewing fare as commercials and "Barnaby Jones." Only minutes after watching, the typical viewer missed 23 to 36% of the questions about what he or she had seen. Of course they did - they were going in and out of trance! If you go into a deep trance, you must be instructed to remember - otherwise you automatically forget.

I have just touched the tip of the iceberg. When you start to combine subliminal messages behind the music, subliminal visuals, projected on the screen, hypnotically produced visual effects, sustained musical beats at a trance-inducing pace ... you have extremely effective brainwashing. Every hour that

you spend watching the TV set you become more conditioned. and, in case you thought there was a law against any of these things, guess again. There isn't! There are a lot of powerful people who obviously prefer things exactly the way they are.

## Maybe they have plans for you?

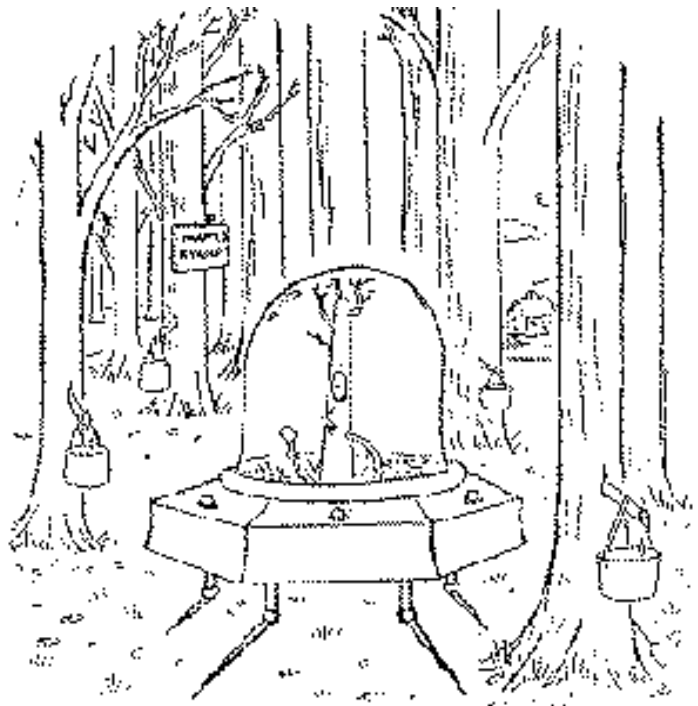

The people here are non-aggressive and suffer from severe incurialence

Sutphen

# TOWARDS BIG BROTHER <sup>oa</sup>

## BEWARE OF I.D. CARDS IN MEDICARE CLOTHING

Guess what? - the same people who tried to foist the ID Card or Australia Card upon us, are now claiming that the soon to be issued 'new improved' Medicare Card - is also going to 'not invade our privacy'.

It doesn't take much digging to uncover that in 1987 the Health Insurance Commission spent \$35 million investigating the establishment of an ID System, with the bulk of this money being spent on video scan camera equipment, to record still video images onto magnetic strips.

A Health Insurance Commission spokesman last year confirmed the new cards would have 3 magnetic strips, but that only one would be used for your Medicare number. The rest were "spares" according to this spokesman.

Privacy Commissioner Kevin O'Connor has given assurances that it will not threaten privacy.

This sounds pretty hollow just when we are being told of the latest form of credit card fraud - copying the magnetic strips on credit cards, a practice rife in South East Asian countries.

Last but not least, it has been revealed that some of our biggest banks have been using and trafficking in confidential information. The Independent Commission Against Corruption (ICAC) has heard that Westpac, for example, gained access to files held by bodies such as the Roads & Traffic Authority, Dept of Social Security, Telecom, Australia Post, and of course - MEDICARE.

Westpac was not alone, the ICAC has also heard evidence that the ANZ Bank and NAB have also gained access to government information.

*(Sources: The Syd Morn Herald, Courier Mail, Daily Telegraph Mirror, Inside News)*

## THOSE FABULOUS FABIANS

EXTRACTS FROM:  
A SPEECH BY THE PRIME  
MINISTER AT THE FABIAN  
SOCIETY CENTENARY DINNER  
IN MELBOURNE - 18th MAY 1984

"For tonight we are marking the centenary of a Society and an idea which, of its very nature, could not at its birth be thought to have had much chance of survival at all - much less survive into the very end of the 20th Century."

"Fabian Societies were formed here as early as 1896. As Frank Crean has recalled, the present Society, the Fabian Society of Victoria, - now I am pleased to say, properly named the Fabian Society of Australia - was formed in 1947.

And of course that was a very significant year in the history of the Australian Labor Party and the Australian Labor Movement."

"...the year 1947 represented both a high tide, and turning of the tide, for post war Labor, and for the Chifley Labor Government. It was for the movement as a whole a year of great optimism and enthusiasm and achievement. The work of post war reconstruction was going on apace. Full employment was established as a national principle and a national goal.

But 1947 was also a year when the challenge against bank nationalisation forced on us a realisation of the restrictions and restraints imposed by the Constitution, and in particular by Section 92.

Consequently, this led to a rethinking of our approach. Because, unless the Platform was just to stagnate into irrelevance, the search had to be made for alternative means of achieving our objectives.

And in that search - and it was a search and a development of policy that went on for more than 20 years - Fabians were in the forefront - Fabians like Frank Crean, Jim Cairns, Kim Beazley, Race Mathews, and not least our own Fabius Maximus - Gough Whitlam himself."

"But above all, the ongoing importance of Fabianism in Australia has been to help bring to our movement, and our cause, that quality which I said before was the essence

of social democracy - the need for a sense of relevance, in the application of our ideas and our ideals to practical purposed and achievable goals.

And in this I gladly acknowledge the debt of my own Government to Fabianism.

"For the right moment you must wait, as Fabius did, most patiently, when warring against Hannibal, though many censured his delays; but when the time comes you must strike hard, as Fabius did, or your waiting will be in vain and fruitless

## POLICE CONFESSION ON DRUG WAR?

This message is reprinted from a  
photocopied handout at the  
Midwest Marijuana Harvest Fest  
in Madison, WI.(USA)  
Sunday, Sept 30, 1990

We are a small group of veteran police officers, who feel that it is our civic duty to expose certain unwritten policies and attitudes of our officials and fellow officers, regarding the "War On Drugs". An attitude that the civilian population is the enemy, and the policy is to advance and attack. Another attitude is that we must assist our department in obtaining more funding, and to expand our powers to the point that we have totally disregarded the rights of others. We have all participated in a large number of drug raids., and over the last few months, the nature of these raids has changed.

Slowly, but steadily it has become an un-written policy, and practice with some of our fellow-officers to carry what is known as "throw-away" drugs; just as it has always been the practice for some officers to carry "throw-away" pistols. Until a few months ago, it was rare to use these throw-aways, unless we had strong circumstantial evidence that the suspect was a dealer or user of drugs.

We know, that because of the stepped-up efforts in enforcement, that a good share of the raids that we

go on are instituted by a vindictive neighbor, an overzealous neighborhood watch participant, or maybe an angry relative or something of that nature. We know that some of the officers are dumping drugs on these people during raids, but we don't know just how many innocents are affected by this practice.

To our amazement, we are able to obtain a search warrant from almost any Judge by giving nothing more than the person's name and address.

During our weekly card games, our group has discussed this this matter at length; and we feel that if left unchecked that the system will reduce us as officers to nothing more than feared S.S. officers.

We know that we are systematically displacing large numbers of black males and poor white males through arrest and imprisonment; and we are getting increased pressure to get into the middle-class areas, to confiscate more property of higher value.

We are not offering any political

solutions to the situation and we are not suggesting that we stop the war on crime, but we feel that the public and the courts should be more concerned with individual civil rights if we are not to become a brutal police state.

Unfortunately, already, we as officers must protect our identity and our location from our own union, department heads, and fellow officers in fear of serious reprisals from within, for voicing our criticisms. Therefore, we are mailing this letter at our own expense to various people whom we feel may effectively inform the public in one way or another.

Please copy and distribute!

## GULF WAR MEDIA CENSORSHIP

The return to Australia of retired US Army colonel David Hackworth, one of the US army's most decorated soldiers has revealed some startling

insights into how the military controlled the media during the campaign.

"Correspondents were restricted from each access, fired upon, blindfolded, thumped with rifle butts, arrested, made to play out the propaganda games of the military high command, interrogated and treated with total paranoia.

"Many journalists had their credentials removed, or threatened to have their credentials removed. I think it is sometimes forgotten that in two countries, Australia and America, that it was an elected Parliament and an elected Congress that sent forces to the gulf. The people who elected those governments damn well deserved to know what those forces were doing."

"No journalist could go forward of a line without a military escort. This escort had to approve everything you saw, every question you asked and so on. Soldiers were ordered not to talk to the press full-stop."

(Source: *Courier Mail*,  
Sat 6th April 1991)

# WHY I CHANGED MY OPINION ABOUT FLUORIDATION

*Continued from page 9*

## References :

- Bille J, Hesselgren K, Thylstrup A (1986) Dental caries in Danish 7, 11 and 13-year-old children in 1963, 1972 and 1981. *Caries Research* 20, pp.534 - 542.
- Colquhoun J (1984a) New evidence on fluoridation. *Social Science & Medicine* 19, 1239-1246.
- Colquhoun J (1984b) Disfiguring dental fluorosis in Auckland, New Zealand. *Fluoride* 17, 66-72.
- Colquhoun J (1985) Influence of social class and fluoridation on child dental health. *Community Dentistry & Oral Epidemiology* 13, 37-41.
- Colquhoun J (1986) Letter. *Nature* 324, 298.
- Colquhoun J (1987) Child dental health differences in New Zealand. *Community Health Studies* 11(2), 85-90.
- Colquhoun J (1988) Decline in primary tooth decay in New Zealand. *Community Health Studies* 12(2), (in press).
- Colquhoun J, Mann R (1986, 1987) The Hastings Fluoridation Experiment: Science or Swindle? *The Ecologist* 16(6), 432-438. Postscript. *The Ecologist* 17(2), 125-126. Updated and presented as "A re-examination of New Zealand's fluoridation trial" to the 56th Congress of the Australian and New Zealand Association for the Advancement of Science at Massey University, Palmerstone North, New Zealand, Jan 1987.
- Cutress TW, Suckling GW, Pearce EIF, Ball ME (1985) Defects of tooth enamel in children in fluoridated and non-fluoridated water areas of the Auckland Region. *NZ Dental Journal* 81, pp.12-19.
- Diesendorf M (1986a) The mystery of declining tooth decay. *Nature* 322, pp.125-129.
- Diesendorf M (1986b) A re-examination of Aust. fluoridation trials. *Search* 17, pp.256-261.
- Diesendorf M (1987) Letter. *The Ecologist* 17(4/5), 207.
- Diesendorf M, Sutton PRN (1986) Fluorides: New Grounds for Concern. *The Ecologist* 16, p237-42
- Gray AS (1987) Fluoridation: Time for a new baseline? *Journal of the Canadian Dental Association* 53(10), pp.763-765.
- Grimberden GW (1974) A double blind test for determination of intolerance to fluoridated water (preliminary report). *Fluoride* 7, 146-152.
- Hamilton V, Birkbeck JA (1985) The Home Style survey of New Zealand's changing diet. Quality Bakers, Palmerston North.
- Srikantia SG (1984) Endemic fluorosis in Andhra Pradesh. *Bulletin of Nutrition Foundation of India* 5, 2-4.
- Schatz A (1976) Increased death rates in Chile associated with artificial fluoridation of drinking water, with implications for other countries. *Journal of Arts, Science and Humanities* 2,1-17.
- Susheela AK (1984) Epidemiology and control of fluorosis in India. *Bulletin of Nutrition Foundation of India* 5, 2-4.
- Sutton PRN (1960) *Fluoridation: errors and omissions in experimental trials*. (2nd ed.) Melbourne University Press, Melbourne.
- Sutton PRN (1987) Does fluoride ingestion affect developing immune system cells? *Medical Hypotheses* 23, 335-336.
- Thylstrup A, Fejerskov C, Bruun C, Kann J (1979) Enamel changes and dental caries in 7 year old children given fluoride tablets from shortly after birth. *Caries Research* 13, 265-276.
- Waldbott GL, Burgstahler AW, McKinney HL (1978) *Fluoridation: the Great Dilemma*. Coranado Press, Lawrence Kansas.



## PLACES WHERE GRAVITY "FALLS UP"

Motorists driving along Croy Brae in Strathclyde, Scotland, sooner or later usually slow down - or stop completely - in utter confusion. For Croy Brae is one of the most disorienting places on earth.

Approaching the brae ("hill") from the north is an uncanny experience. The road appears to slope downward, and drivers assume that the slope will accelerate the vehicle. Yet if they slow down, they are likely to grind to a complete halt.

Despite every appearance to the contrary, the road runs uphill, not downhill. Unable to believe what has happened, many motorists stop, only to find that their cars begin to slide backward, "uphill".

Travelers who are approaching from the south experience a similar topsy-turvy sensation. Thinking they are heading uphill they accelerate - only to discover they are speeding along faster than they had intended. The road actually goes 'down'.

No one has yet been able to come up with a totally satisfactory explanation of what causes these strange effects at Croy

Brae. Whatever the explanation, the phenomenon is not unique to Croy; there are similar places all over the world. One example can be found on the road to Jerusalem near the village of Djabal Moukaber, Israel. And on Mystery Hill, a small area between Boone and Blowing rock, North Carolina, a river reportedly flows north and apple trees grow into the prevailing winds, seemingly in complete defiance of the laws of nature.

In an letter to a magazine, a British visitor to Canada described how an uncle had taken him to "a rather unusual but fascinating place" near Vancouver. "He parked his huge station wagon on a bumpy road with a steep gradient, and then took the key out of the ignition and released the handbrake. There were eight of us in the car but, to my astonishment, it nevertheless began to move - uphill. My uncle then poured some water from a nearby stream onto the surface of the road, and this too began to flow uphill."

The best-known example in North America is Magnetic Hill at Moncton, New Brunswick, Canada. According to local legend, its mysterious properties were first noticed in the 1930's when a milkman stopped his horse and cart at the bottom to make a delivery. When he

returned, to his astonishment he found that both horse and cart had drifted halfway "up" the hill.

## US JUDGE WITH WEATHER CONTROL?

San Francisco: - A judge who ordered the rain to stop in 1986, at the beginning of California's five-year drought, recently rescinded that order - and it has poured ever since.

District Judge Samuel King, annoyed by jurors being unable to attend his court because of heavy rains, declared in 1986: "I hereby order that it cease raining by Tuesday. Let's see how that works."

It worked so well the state is now in its fifth year of severe drought.

Reminded recently of his motion, Judge King proclaimed, tongue-in-cheek: "I hereby rescind my order of 1986 and order that rain shall fall."

On that day, a fierce storm drenched California with more than 100mm of rain. Two smaller storms have added another 75mm, and rain and winds continued yesterday.

## UFO SIGHTINGS MORE FREQUENT IN QUEENSLAND SAYS RESEARCH CENTRE

Of the 150 sightings reported to the UFO Research Centre in Qld last year, more than two thirds, or 110, came from folk living in central Queensland.

NSW residents reported only 40 sightings.

It should be added that the number of people who do not report sightings is significantly higher than those who do.

## MISSING PERSONS - WHERE DO THEY GO?

According to a newspaper clipping sent to me (Daily Telegraph/Mirror 11.7.90 p12) "More than 4,000 people have been reported missing this year in NSW alone".

Now, if that clipping is dated 11th July, that works out at nearly 21 people disappearing per day, from NSW alone!

Even supposing the clipping is dated the 7th of November 1990, it still means that over 12 people a day disappear in NSW alone!

The person who sent in this clipping wrote alongside the article - "missing or UFO snack food?"

*(I had to chuckle. Ed.)*

## UFO'S OVER LIBYA?

You would be amazed at what information I get to hear. On an overseas trip a few years ago, I had a chance to speak to several Libyans.

The magazine I was representing at the time, had recently published a small article covering UFO's. This caught their eye, and I was promptly told of a very large UFO that hovered over Tripoli one night.

Guess which night that was? It was the night that the U.S.A bombed Libya, in

apparent retaliation for a bombed disco in Berlin.

Was it a coincidence that the US launched one of its largest every military missions, on the night that many Libyans were watching a huge stationary UFO hovering over their capital city.

What is even more bizarre are the rumours that Colonel Gaddafi completely "disappeared" during the raid, prompting initial reports that he may have been killed.

Some suggest (very privately) that he was 'taken aboard' the mysterious craft.

Whatever the case, I am still suspicious of the suddenness and the size of the US attack, coincidental with such stories.

## UNUSUAL DISAPPEARANCES & APPEARANCES OF PEOPLE

This subcategory contains 120 cases involved with disappearances or appearances of people under circumstances that have been considered unusual. The former type of phenomenon is by far the most frequent; appearances in this division are rare. Most of the cases in this subcategory involve groups of people, eg armies, ship's crews, etc. Their common feature is the relatively short period of time in which the large number of disappearances took place. In some cases involving disappearing ships' crews, boarding parties discovered hot food still in the galley or warm coffee still in the cups. Sample cases included:

1. \_,1850/ Easton Beach, Rhode Island/ the Seabird found; crew missing.
2. 1858/Saigon, Vietnam/ 650 French troops disappear.
3. August, 1869/ Cork, Ireland/ 13 children about the same age disappear
4. January, 1874/ Paris, France (area)/ repeated disappearances of young men.
5. 23 September, 1880/ Gallatin, Tennessee/ case of David Lang; walks into a field and disappears
6. July, 1883/ Montreal, Quebec, Canada / unaccountable disappearances of many men.
7. 23 November, 1886/ Edina, Missouri/ 3 boys and father hit by lightning; one of them 'disappears'
8. January, 1888/ Connecticut/ sudden

appearance of several 'wild men'; speaking gibberish

9. 24 December, 1890/ South Bend, Indiana/ another case of man disappearing into thin air in view of witnesses

10. January, 1905/ In different parts of England/ sudden appearance of 10 wild men, speaking gibberish.

11. 28 August, 1915/ Constantinople, Turkey/ entire regiment seen to disappear into strange clouds that descended to earth.

12. October, 1955/ Fiji Islands/ disappearance of crew from the Joyita

13. 30 July, 1960/ Picton Ontario/ thirteen year old boy disappears in spot; found in same spot five days later; amnesia of days missing.

*(From Chapter 10, of "Space-Time Transients & Unusual Events" by Michael A. Persinger & Gyslaine F. Lafre-niere. Published by Nelson-Hall, Chicago 1977)*

## SUPERNATURAL KIDNAPPERS?

A terrified father has told police of his ordeal where he fought to rescue his screaming two year old son from the clutches of a ghost.

Mr Martin Rivers of Westcliff-on-Sea, in Essex, UK claimed he grappled with the male spook after finding his son floating 5 feet in the air in his bedroom.

Police say they are taking the story seriously and are looking for an exorcist to visit the house. A spokesperson said: "We are satisfied he had a supernatural experience." He added that Mr Rivers claimed the spirit threw furniture around and hurled the family dog into a cupboard.

Mr Rivers and his son were alone in the terraced house while his wife was in hospital having a baby. They have now moved out.

## LOTTERY WINNER STRIKES TWICE!

A lucky man in Wellington, New Zealand recently collected winnings of more than \$A250,000 from the NZ Lotteries Commission.

As he left he joked "see you next week". He did. The next week he returned to collect half-share of \$A207,000.

# REVIEWS



Reviews by Duncan Roads  
and Cathy Simons

## BOOKS

### **CROP CIRCLES THE LATEST EVIDENCE**

By Pat Delgado &  
Colin Andrews

Publishers: Bloomsbury  
UK. (Allen & Unwin )

Each summer in the south of England for the last few years, the phenomenon known around the world as 'crop circles' intensifies in both frequency and complexity. This book illustrates the startling variety of these patterns or pictograms as some prefer to call them.

The book is full of colour photos taken by two of Britains most dedicated researchers into this mystery.

### **THE COSMIC PULSE OF LIFE**

The Revolutionary  
Biological Power  
behind UFO's.

By Trevor J. Constable  
Publ:Borderland  
Sciences Research  
Foundation, Garberville,  
CA. USA.

This book shows that what the existence of UFO's has done, is to blow holes in the 'old order' of science - 'mechanism'.

UFO's have brought with them a new source of energy, a new mode of propulsion and the conquest of gravity. In this book the author penetrates the basic determinism of this energy, and demonstrates his ideas on why it is that the social and scientific reaction to its discovery and development has been irrational, repressive and antagonistic.

This book traces the author's research into UFO's, 'life-force' energy, and the research and influence of pioneers such as Dr. Rudolph Steiner, Wilhelm Reich, and Dr. Ruth Drown in this field.

The author also alludes to a "battle for Planet Earth", between positive influences and disruptive or negative influences. He

points out that the invasion route used by the negative forces (Ahrimanic) is not from 'outer space' but from 'inner space'!

This book is well worth obtaining. Mr Constable has had 25 years service as a Radio Electronics Officer in the US Merchant Marine, and is an acclaimed aviation and military historian.

Available from Alternative Access (see advert this page) or Esoteric Sciences Bookshop (see advert)

### **BIRTH STORIES A Collection of Personal Experiences** Edited by Klay Lamprell Published by Angus & Robertson

An excellent collection of personal accounts that me impatient to experience childbirth myself.

The accounts range from stories of home-births, stories viewed by other children, fathers, migrant women, aboriginal women, and of course many of these were having their first child, thus making their description that little extra special.

If you are pregnant and do not know what to expect, either in sensations, or reactions - then I am sure you will find this book putting you at ease somewhat.

### **THE SIGN OF THE SERPENT**

by Mark Balfour  
Published by: Prism Press  
UK; Unity Press Australia

Since the dawn of recorded civilisation, the symbology of the serpent has been found on every continent with striking parallels.

From the Rainbow Serpent of Aboriginal Dreamtime, to the Dragon Paths of China and the snake worshippers of India - the symbology of the serpent is strikingly uniform - representing life force energy.

This books is a rare synthesis, blending eastern mysticism with western physics in an informative manner.

The author uses his experience as an international photo-journalist drawing from many trips to the India sub-continent and remote Australia.

One of the most exciting chapters in this book is titled 'A New Physics of Creation - a thrust towards unity?'

It combines the discovery of the vortex energy field made at Sydney University on a few years ago, with an exciting synthesis of ancient mysticism and modern quantum physics.

### **MEMORIES & VISIONS OF PARADISE**

Exploring the  
Universal Myth of a  
Lost Golden Age  
by Richard Heinberg  
CollinsAngus&Robertson

Woven throughout the oral and written histories of nearly culture is the Myth of Eden, or Paradise. At time and place when all was in perfect harmony with the cosmos.

The similarities between cultures spanning both distance and time has never ceased to amaze me - does it mean that we all come from a common source, or does it represent an archetype of conscious.

Either way, this book is a remarkable collection of luminous passages from a multitude of great scriptures and folktales.

I have always been struck by the global uniformity of the deluge legends. These tales are so similar from so many cultures that I feel one day we will be re-writing our history books instead of ignoring such clues to our past.

### **THE COURTESANS The Press Gallery in the Hawke Era.**

by Derek Parker  
Published by: Allen &  
Unwin (Australia)

This book is an interesting look at the relationships between the media and governments, not just the Hawke Government as the title would have us believe.

The book is mainly covers the story of the relationship between the Press Gallery and the Hawke Govt, which is described as the most media conscious government Australia has ever seen.

It shows just how easily news is manipulated - not only in sinister conspiratorial



fashions, but also in ways which are based on pure competition to run the 'main stories' each day.

It is a revealing look at how the media can be used to curb politicians, and how politicians can curb journalists, etc.

Some examples are rather chilling, some are downright humorous.

If you have ever wondered about media manipulation, I seriously recommend you get this book. To understand the psychology of both journos and polities is worth the effort.

## TAPES

### SHAMANIC DREAM

by Anugama

Readers of previous Nexus Magazines will have learned how certain high-frequency noise can affect the brain in varying ways.

This tape, apart from having very pleasant music and sounds to listen to, actually performs "sound therapy" while you are listening.

Shamanic Dream utilises Theta Sounds, which have a frequency range of 4 to 7 Hz. Research has shown that, after being exposed to Theta Sounds for a while, the body enters an extremely relaxed state.

The tape initially uses soft Indian drums and percussion, which give a soft heartbeat rhythm. This is accompanied by a hollow sounding wind instrument, which gives the effect of echoing in the hills.

Side two uses various soft instruments, including the synthesiser and soft humming voices.

In all honesty I can say I have listened to scores of different relaxation or new age music tapes, but this one actually made me feel relaxed in a more pronounced way.

It was not until I started reviewing the tape that I noticed it had specifically designed frequencies included for such purposes.

If you want a proven relaxation tape, I can personally recommend it.

Available from New Age Music, Box 789, Fremantle, WA. 6160, Ph: 09 336 2842.